

HP 8751A NETWORK ANALYZER OPERATION MANUAL

SERIAL NUMBERS

This manual applies directly to instruments with serial number prefix 3026J.
For additional important information about serial numbers, read
“Serial Number” in General Information of this Operation Manual.



**HEWLETT
PACKARD**

HP Part No. 08751-90000
Microfiche Part No. 08751-90050
Printed in JAPAN October 1990

Notice

The information contained in this document is subject to change without notice.

This document contains proprietary information which is protected by copyright. All rights are reserved. No part of this document may be photocopied, reproduced, or translated to another language without the prior written consent of the Hewlett-Packard Company.

Yokogawa-Hewlett-Packard, LTD.
YHP Instrument Operation
9-1, Takakura-cho, Hachioji-shi,
Tokyo, 192 Japan

Documentation Map

Operation Manual Set (HP Part Number 08751-90000)

User's Guide

The User's Guide walks you through system setup and initial power-on, shows how to make basic measurements, explains commonly used features, and tells you how to get the most performance from your analyzer. After you receive your HP 8751A, begin with this manual. (P/N 08751-90001)

General Information

The General Information provides general information, specifications.

Reference Manual

The Reference Manual provides in-depth reference information.

HP-IB Programming Manual

The HP-IB Programming Guide provides a summary of all available HP-IB command, and shows how to make basic program to control the HP 8751A by a controller via HP-IB.

Maintenance Manual (HP Part Number 08751-90030)

The Maintenance Manual explains how to verify conformance to published specifications.

Service Manual (Option 915), (HP Part Number 08751-90031)

The Service Manual explains how to adjust, troubleshoot, and repair the instrument.

Using HP Instrument BASIC with the HP 8751A

The Using HP Instrument BASIC with the HP 8751A describes how HP Instrument BASIC works with the HP 8751A and any unique features.

HP Instrument BASIC Manual Set (Option 002 only), (HP Part Number E2083-90000)

HP Instrument BASIC User's Handbook

The HP Instrument BASIC User's Handbook provides some helpful hints on getting the most use from HP Instrument BASIC programming language, and provides a general programming reference. This manual is furnished option 002.

HP Instrument BASIC Language Reference

The HP Instrument BASIC Language Reference provides a summary of all available HP Instrument BASIC Language. This manual is furnished option 002.

Manual Printing History

The manual printing date and part number indicate its current edition. The printing date changes when a new edition is printed. (Minor corrections and updates which are incorporated at reprint do not cause the date to change.) The manual part number changes when extensive technical changes are incorporated.

October 1990. . . . 1st. Edition

Safety Summary

The following general safety precautions must be observed during all phases of operation, service, and repair of this instrument. Failure to comply with these precautions or with specific *WARNINGS* given elsewhere in this manual violates safety standards of design, manufacture, and intended use of the instrument.

The Hewlett-Packard Company assumes no liability for the customer's failure to comply with these requirements.

Ground The Instrument

This is a Safety Class 1 product (provided with a protective earthing terminal). An uninterruptible safety earth ground must be provided from the main power source to the product input wiring terminals, power source to the product input wiring terminals, power cord, or supplied power cord set. Whenever it is likely that the protection has been impaired, the product must be made inoperative and secured against any unintended operation.

DO NOT Operate In An Explosive Atmosphere

Do not operate the instrument in the presence of flammable gasses or fumes. Operation of any electrical instrument in such an environment constitutes a safety hazard.

Keep Away From Live Circuits

Operating personnel must not remove instrument covers. Component replacement and internal adjustments must be made by qualified maintenance personnel. Do not replace components with the power cable connected. Under certain conditions, dangerous voltages may exist even with the power cable removed. To avoid injuries, always disconnect power and discharge circuits before touching them.

DO NOT Service Or Adjust Alone

Do not attempt internal service or adjustment unless another person, capable of rendering first aid and resuscitation, is present.

DO NOT Substitute Parts Or Modify Instrument

Because of the danger of introducing additional hazards, do not substitute parts or perform unauthorized modifications to the instrument. Return the instrument to a Hewlett-Packard Sales and Service Office for service and repair to ensure the safety features are maintained.

Dangerous Procedure Warnings

Warnings, such as the example below, precede potentially dangerous procedures throughout this manual. Instructions contained in the warnings must be followed.

Warning





Dangerous voltages, capable of causing death, are present in this instrument. Use extreme caution when handling, testing, and adjusting this instrument.

How To Use This Manual

This is the Operating Manual for the HP 8751A Network Analyzer. This manual contains specifications, installation, configuration, and operation in the procedure following documentations. After you receive your HP 8751A, begin with chapter 1. of Users Guide.

For error messages of the HP 8751A, refer to Error Message in the Operation Manual.

Typeface Conventions

- Bold** Boldface type is used when a term is defined. For example: **icons** are symbols.
- Italics* Italic type is used for emphasis and for titles of manuals and other publications.
- Italic type is also used for keyboard entries when a name or a variable must be typed in place of the words in italics. For example: *copy filename* means to type the word *copy*, to type a space, and then to type the name of a file such as *file1*.
- Computer** Computer font is used for on-screen prompts and messages.
- HARDKEYS** Labeled keys on the instrument front panel are enclosed in .
- SOFTKEYS** Softkeys located to the right of the CRT are enclosed in .

Certification

Hewlett-Packard Company certifies that this product met its published specifications at the time of shipment from the factory. Hewlett-Packard further certifies that its calibration measurements are traceable to the United States National Institute for Standards and Technology, to the extent allowed by the Institution's calibration facility, or to the calibration facilities of other International Standards Organization members.

Warranty

This Hewlett-Packard instrument product is warranted against defects in material and workmanship for a period of one year from the date of shipment, except that in the case of certain components listed in *General Information* of this manual, the warranty shall be for the specified period. During the warranty period, Hewlett-Packard Company will, at its option, either repair or replace products which prove to be defective.

For warranty service or repair, this product must be returned to a service facility designated by HP. Buyer shall prepay shipping charges to HP and HP shall pay shipping charges to return the product to Buyer. However, Buyer shall pay all shipping charges, duties, and taxes for products returned to HP from another country.

HP warrants that its software and firmware designated by HP for use with an instrument will execute its programming instruction when properly installed on that instrument. HP does not warrant that the operation of the instrument, or software, or firmware will be uninterrupted or error free.

Limitation Of Warranty

The foregoing warranty shall not apply to defects resulting from improper or adequate maintenance by Buyer, Buyer-supplied software or interfacing, unauthorized modification or misuse, operation outside of the environment specifications for the product, or improper site preparation or maintenance.

No other warranty is expressed or implied. HP specifically disclaims the implied warranties of merchantability and fitness for a particular purpose.

Exclusive Remedies

The remedies provided herein are buyer's sole and exclusive remedies. HP shall not be liable for any direct, indirect, special, incidental, or consequential damages, whether based on contract, tort, or any other legal theory.

Assistance

Product maintenance agreements and other customer assistance agreements are available for Hewlett-Packard products.

For any assistance, contact your nearest Hewlett-Packard Sales and Service Office. Address are provided at the back of this manual.

Safety Symbols

General definitions of safety symbols used on equipment or in manuals.



Instruction manual symbol: the product will be marked with this symbol when it is necessary for the user to refer to the instruction manual in order to protect against damage to the instrument.



Indicates dangerous voltage (terminals fed from the interior by voltage exceeding 1000 volts must be so marked).

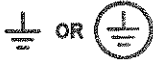

Protective conductor terminal. For protection against electrical shock in case of a fault. Used with wiring terminals to indicate the terminal which must be connected to ground before operating equipment.



Low-noise or noiseless, clean ground (earth) terminal. Used for a signal common, as well as providing protection against electrical shock in case of fault. A terminal marked with this symbol must be connected to ground in the manner described in the installation (Operation) manual, and before operating the equipment.

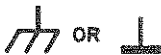

Frame or chassis terminal. A connection to the frame (chassis) of the equipment which normally includes all exposed metal structures.



Alternating current (power line).



Direct current (power line).



Alternating or direct current (power line).

Warning



Warning denotes a hazard. It calls attention to a procedure, practice, condition or the like, which, if not correctly performed or adhered to, could result in injury or death to personnel.

Caution



Caution sign denotes a hazard. It calls attention to a procedure, practice, condition or the like, which, if not correctly performed or adhered to, could result damage to or destruction of part or all of the product.

Note



Note denotes important information. It calls attention to a procedure, practice, condition or the like, which is essential to highlight.

HP 8751A NETWORK ANALYZER
GENERAL INFORMATION



Printed in JAPAN October 1990

Contents

1. General Information	
ABOUT THIS MANUAL SET	1-1
Instruments Covered by This Manual	1-1
Microfiche Copies of the Manual	1-1
HP 8751A DESCRIPTION	1-2
Additional Features	1-2
Advanced List Sweep Mode	1-2
Automatic Sweep Time	1-2
Automatic Interpolated Error Correction	1-2
Conjugate Matching	1-3
Four Trace Simultaneous Measurement	1-3
HP Instrument BASIC (Option 002)	1-3
I/O port	1-3
System Description	1-3
HEWLETT-PACKARD INTERFACE BUS (HP-IB)	1-4
OPTIONS AVAILABLE	1-4
Option 001, High Stability Frequency Reference	1-4
Option 002, HP Instrument BASIC	1-4
Option 008, Add Japanese Manual Set	1-4
Option 009, Delete Manual Set	1-4
Option 907, Front Handle Kit	1-4
Option 908, Rack Mount Kit	1-4
Option 909, Rack Mount Flange and Handle Kit	1-5
Option 910, Extra Manual Set	1-5
Option 915, Add Service Manual (HP Part Number: 08751-90031)	1-5
TEST SETS REQUIRED	1-5
HP 87511A/B S-Parameter Test Sets	1-5
HP 87512A/B Transmission/Reflection Test Kits	1-5
Other Test Sets Available	1-5
HP 85046A/B S-parameter Test Sets	1-5
HP 85044A/B Transmission/Reflection Test Sets	1-5
MEASUREMENT ACCESSORIES AVAILABLE	1-6
Power Splitters	1-6
HP 11850C/D Three-Way Power Splitters	1-6
HP 11667A Power Splitter	1-6
Active Probes	1-6
HP 41800A Active Probe	1-6
HP 41802A 1 M Ω Input Adapter	1-6
Calibration Kits	1-6
Test Port Return Cables	1-6
HP 11857D 7 mm Test Port Return cable Set	1-7
HP 11857B 75 Ω Type-N Test Port Return Cable Set	1-7

HP 11851B 50 Ω Type-N RF Cable Set	1-7
Adapter Kits	1-7
HP 11852B 50 Ω to 75 Ω Minimum Loss Pad	1-7
SYSTEM ACCESSORIES AVAILABLE	1-8
System Rack	1-8
Plotters and Printers	1-8
HP-IB Cables	1-8
Computer	1-8
Disks and Disk Accessories	1-9
External Monitors	1-9
RECOMMENDED TEST EQUIPMENT	1-9

2. Instrument Specifications

SOURCE	2-1
Frequency Characteristics	2-1
Output Power Characteristics	2-1
Spectral Purity Characteristics	2-2
Sweep Characteristics	2-2
Frequency Sweep	2-2
Power Sweep	2-2
Others	2-3
RECEIVER	2-3
Input Characteristics	2-3
Magnitude Characteristics	2-4
Absolute Characteristics	2-4
Ratio Characteristics	2-5
Phase Characteristics	2-5
Delay Characteristics	2-7
DC Voltage Measurement Characteristics for INPUT B	2-7
GENERAL CHARACTERISTICS	2-7
REAR PANEL SPECIFICATIONS	2-8
I/O Buses	2-8
HP-IB Interface	2-8
S-Parameter Test Set Interface	2-8
I/O Port	2-9
BNC Connectors	2-9
“EXT REF INPUT 10/N MHz” Connector	2-9
“REF OVEN (OPTION 001)” Connector	2-9
“INT REF OUTPUT” Connector	2-9
“EXT TRIGGER” Connector	2-9
“EXT PROG RUN/CONT” Connector	2-10
“EXT MONITOR” Connectors	2-10
FURNISHED ACCESSORIES	2-10
TYPICAL SYSTEM PERFORMANCE	2-12
Introduction	2-12
Comparison Of Typical Error-Corrected Measurement Uncertainty	2-12
Reflection Uncertainty of a One-Port Device	2-13
Reflection Uncertainty of a Two-Port Device	2-14
Transmission Uncertainty of a Low-Loss Device	2-15
Transmission Uncertainty of a Wide Dynamic Range Device	2-16
TYPES OF RESIDUAL MEASUREMENT ERRORS	2-17

Residual Systematic Errors	2-17
Residual Random Errors	2-17
Residual Drift Errors	2-17
SYSTEM ERROR MODE	2-18
REFLECTION UNCERTAINTY EQUATIONS	2-20
Total Reflection Magnitude Uncertainty (E_{rm})	2-20
Total Reflection Phase Uncertainty (E_{rp})	2-20
TRANSMISSION UNCERTAINTY EQUATIONS	2-21
Total Transmission Magnitude Uncertainty (E_{tm})	2-21
Total Transmission Phase Uncertainty (E_{tp})	2-21
DYNAMIC ACCURACY	2-22
Definitions	2-22
Determining Relative Dynamic Accuracy Error Contribution	2-22
Dynamic Accuracy Error Contribution	2-23
Dynamic Accuracy Error Contribution	2-24
Dynamic Accuracy Error Contribution	2-25
EFFECTS OF TEMPERATURE DRIFT	2-26
Temperature Drift with S_{11} One-Port Calibration	2-27
Temperature Drift with Full Two-Port Calibration	2-28
SYSTEM PERFORMANCE WITH DIFFERENT TEST SETS AND CONNECTOR TYPES	2-29
DETERMINING EXPECTED SYSTEM PERFORMANCE	2-31
Procedures	2-31

Figures

1-1. Typical Serial Number Plate	1-1
2-1. Average Noise Level on Magnitude Measurement	2-4
2-2. Dynamic Accuracy (Amplitude)	2-5
2-3. Dynamic Accuracy (Phase)	2-6
2-4. S-Parameter Test Set Interface Pin Assignments	2-8
2-5. Trigger Signal	2-10
2-6. Power Cables Supplied	2-11
2-7. Total Reflection Magnitude Uncertainty	2-13
2-8. Total Reflection Phase Uncertainty	2-13
2-9. Total Reflections Magnitude Uncertainty	2-14
2-10. Total Reflection Phase Uncertainty	2-14
2-11. Total Transmission Magnitude Uncertainty	2-15
2-12. Total Transmission Phase Uncertainty	2-15
2-13. Total Transmission Magnitude Uncertainty	2-16
2-14. Total Transmission Phase Uncertainty	2-16
2-15. HP 8751A/87511A System Error Model	2-18
2-16. Worst-Case Magnitude Dynamic Accuracy Error	2-23
2-17. Worst-Case Phase Dynamic Accuracy Error	2-23
2-18. Worst-Case Magnitude Dynamic Accuracy Error	2-24
2-19. Worst-Case Phase Dynamic Accuracy Error	2-24
2-20. Worst-Case Magnitude Dynamic Accuracy Error	2-25
2-21. Worst-Case Phase Dynamic Accuracy Error	2-25
2-22. Total Reflection Magnitude Uncertainty	2-27
2-23. Total Reflection Phase Uncertainty	2-27
2-24. Total Transmission Magnitude Uncertainty	2-28
2-25. Total Transmission Phase Uncertainty	2-28

Tables

1-1. Disks and Disk Accessories	1-9
2-1. Parameters of System Error Model	2-19
2-2. Determining Relative Dynamic Accuracy (Linacc)	2-22
2-3. Typical System Performance for Devices	2-30
2-4. Reflection Measurement Uncertainty Worksheet	2-32
2-5. Transmission Measurement Uncertainty Worksheet	2-33

General Information

ABOUT THIS MANUAL SET

This *HP 8751A Network Analyzer Operation Manual* is a complete guide to operating the analyzer alone or as a component in a system. It is part of a two manual set; the *Maintenance Manual* completes the set.

To explore the manuals further, inspect their title pages and the “Contents” and “Index” sections.

Instruments Covered by This Manual

The instrument you received with this manual is covered by this manual without change. Any other instrument with one of the serial number prefixes listed on the title page is also described by this manual. (The serial number plate, shown in Figure 1-1, is attached to the rear panel of the analyzer.)

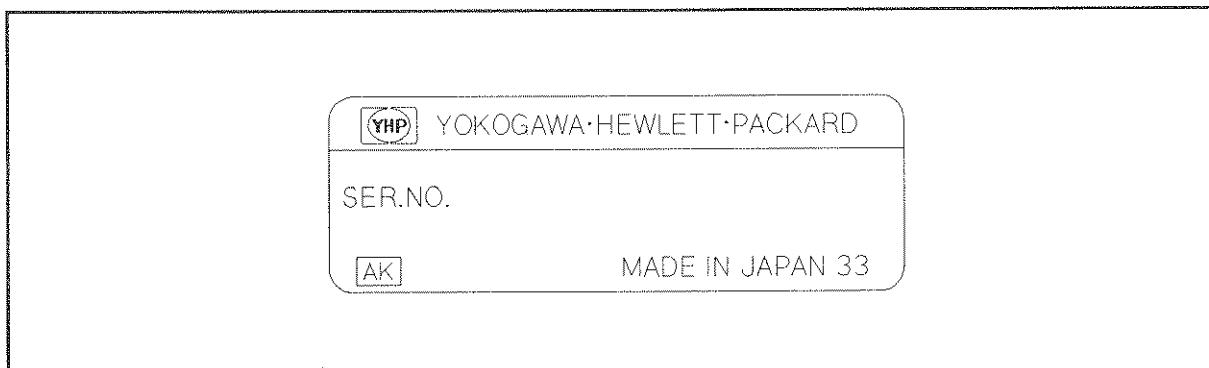

C2101002

Figure 1-1. Typical Serial Number Plate

Other instruments differ from the instruments covered directly by this manual. Those differences are documented in the “Instrument History” section. See “Instrument History” section if the serial number prefix of your instrument is not listed on the title page.

Microfiche Copies of the Manual

Use the microfiche part number on the title page to order a package of 10 × 15 centimeter (4 × 6 inch) microfilm transparencies of this manual and the *Maintenance manual*.

HP 8751A DESCRIPTION

The HP 8751A is a 5 Hz to 500 MHz vector network analyzer for reflection and transmission parameters. It integrates a high resolution synthesized RF source, and a dual channel and three-input receiver to measure and display magnitude, phase, and group delay responses of active and passive RF networks. Option 001 provides a high stability frequency reference. For information on other options, refer to "OPTIONS AVAILABLE" later in this section.

Two independent display channels and a large screen color CRT display the measured results of one or both channels, in rectangular or polar/Smith chart formats. The display function has capability to display three trace simultaneously.

Digital signal processing and microprocessor control combine to provide easy operation and measurement improvement. Measurement functions are selected with front panel keys and softkey menus. Displayed measurement results can be printed or plotted directly with a compatible peripheral without the use of an external computer. A built-in micro flexible disk drive stores and recalls instrument states and trace data (measurement data). Built-in service diagnostics are available to simplify troubleshooting procedures.

Trace math, data averaging, trace smoothing, electrical delay, and accuracy enhancement provide performance improvement and flexibility. Accuracy enhancement methods range from normalizing data to complete one or two port vector error correction. Vector error correction reduces the effects of system directivity, frequency response, source and load match, and crosstalk.

In combination with its compatible test sets and accessories, the analyzer has the ability to make complete reflection and transmission measurements in both 50 and 75 Ω impedance environments.

Additional Features

In addition to the above capabilities, this analyzer has several features:

Advanced List Sweep Mode

The analyzer can measure specifically at user defined frequencies, power levels, IF bandwidths, and number of points as defined in List Segment. The list sweep mode can make the display resolution even, even though the frequency points are not evenly distributed, as well as making the frequency base display even.

Automatic Sweep Time

The analyzer can automatically shorten sweep time as much as possible for the given IF bandwidth, number of points, averaging mode, frequency range, and sweep type.

Automatic Interpolated Error Correction

This allows the operator to perform any type of calibration, and then display any subset of that frequency range or use a different number of points. If the operator changes the stimulus parameter, the analyzer turns the interpolated error correction on, and new error coefficients are interpolated from the coefficients of the original calibration. Interpolated error correction provides a great improvement over uncorrected measurements, but is not specified. Refer to *Chapter 7*.

Conjugate Matching

This calculates the optimum parameters of devices in assumed two element L-C impedance matching networks at a DUT end to obtain optimum power transfer at a specific frequency. Several types of the assumed matching circuit will be selected automatically from among the eight provided candidates depending on the DUT's characteristics.

The operator can simulate the circuit after modifying the parameters to suit to commercially available values.

Four Trace Simultaneous Measurement

The analyzer can measure and display two traces for one channel, which allows four traces simultaneous display using the dual channel display capability. In addition, stimulus values (frequency, power) can range independently for each channel.

HP Instrument BASIC (Option 002)

This allows the analyzer programmability without any external controller. HP Instrument BASIC is subset of HP BASIC and allows all of the analyzer's measurement capabilities and any other HP-IB compatible instrument to be programmed. (Refer to *Using HP Instrument BASIC with the HP 8751A.*)

I/O port

This allows the creation of a production line measurement system when used with an automatic handler. Refer to Appendix C for more information.

System Description

An HP 8751A system consists of the analyzer with one of the following test sets/accessories:

- HP 87511A/B S-parameter test set
- HP 87512A/B transmission/reflection test kit
- HP 11850C/D or 11667A power splitter

In addition to one of the above, a system requires a compatible Hewlett-Packard calibration kit and the necessary cables. The compatible test sets, power splitters, calibration kits, and cables are described under "TEST SETS REQUIRED" and "MEASUREMENT ACCESSORIES AVAILABLE" later in this section.

The system may also include other compatible peripherals such as a printer or plotter. The printer and plotter are described under "SYSTEM ACCESSORIES AVAILABLE" .

The system can be automated with the addition of an HP 9000 series 200 or 300 computer, this allows all of the measurement capabilities to be programmed over the Hewlett-Packard Interface Bus (HP-IB).

HEWLETT-PACKARD INTERFACE BUS (HP-IB)

The analyzer is factory-equipped with a remote programming interface using the Hewlett-Packard Interface Bus (HP-IB). HP-IB is Hewlett-Packard's hardware, software, documentation, and support for IEEE-488.1, IEEE-488.2, IEC-625, and JIS-C1901 worldwide standards for interfacing instruments. This provides a remote operator with the same control of the instrument available to the local operator, except for control of the power line switch and some internal tests. Remote control is maintained by a controlling computer that sends commands or instructions to and receives data from the analyzer using HP-IB. Several output modes are available for output data. A complete general description of HP-IB is available in *Condensed description of the Hewlett-Packard Interface Bus* (HP part number 59401-90030), and in *the Tutorial Description of the Hewlett-Packard Interface Bus* (HP literature number 5952-0156).

The analyzer itself can use HP-IB to output measurement results directly to a compatible printer or plotter without the use of an external computer.

OPTIONS AVAILABLE

Option 001, High Stability Frequency Reference

This option, a 10 MHz crystal in temperature stabilized oven, improves the source signal frequency accuracy and stability.

Option 002, HP Instrument BASIC

See the previous section for information.

Option 008, Add Japanese Manual Set

Option 009, Delete Manual Set

Option 907, Front Handle Kit

Option 908, Rack Mount Kit

This option is a rack mount kit containing a pair of flanges and the necessary hardware to mount the instrument, with handles detached, in an equipment rack with 482.6 mm (19 inches) horizontal spacing.

Option 909, Rack Mount Flange and Handle Kit

This option is a rack mount kit containing a pair of flanges and the necessary hardware to mount the instrument with handles attached in an equipment rack with 482.6 mm (19 inches) horizontal spacing.)

Option 910, Extra Manual Set

This option is an extra manual set containing the same manual set which is furnished with the analyzer.

Option 915, Add Service Manual (HP Part Number: 08751-90031)

TEST SETS REQUIRED

HP 87511A/B S-Parameter Test Sets

These contain the hardware required to make simultaneous transmission and reflection measurement in both the forward and reverse directions. An RF switch in the set is controlled by the analyzer so that reverse measurement can be made without changing the connections to the device under test.

HP 87512A/B Transmission/Reflection Test Kits

These contain the hardware required to make simultaneous transmission and reflection measurement in one direction only.

Other Test Sets Available

HP 85046A/B S-parameter Test Sets

These measure the response of devices from 300 kHz to 500 MHz with HP 8751A. These contain two internal DC bias tees for biasing of active devices.

HP 85044A/B Transmission/Reflection Test Sets

These measure the response of devices from 300 kHz to 500 MHz with HP 8751A. These include a 0 to 70 dB step attenuator manually controllable in 10 steps, and the circuitry necessary to allow biasing of active devices through the test set.

MEASUREMENT ACCESSORIES AVAILABLE

Power Splitters

HP 11850C/D Three-Way Power Splitters

These are four-port, three-way power splitters. One output arm is used as the reference for the network analyzer in making ratio measurements and the other two output arms are test channels. The HP 11850C has a frequency range of DC to 3 GHz and an impedance of 50 Ω the HP 11850D has a frequency range of DC to 2 GHz and an impedance of 75 Ω . Three HP 11852B 50 to 75 Ω minimum loss pads are supplied with the HP 11850D power splitter, to provide a low SWR impedance match between the power splitter and the 50 Ω ports of the network analyzer.

HP 11667A Power Splitter

This is a two-way power splitter with one output arm used for reference and one for test. It has a frequency range of DC to 18 GHz and an impedance of 50 Ω .

Active Probes

HP 41800A Active Probe

This is a high input impedance probe for in-circuit measurement which covers the same frequency range as the HP 8751A.

HP 41802A 1 M Ω Input Adapter

This adapter allows use of a high impedance probe. It has a frequency range of 5 Hz to 100 MHz.

Calibration Kits

The following calibration kits contain precision standards (and required adapters) of the indicated connector type. The standards (known devices) facilitate measurement calibration, also called vector error correction. Refer to the data sheet and ordering guide for additional information. Part numbers for the standards are in their respective manuals.

- HP 85031B 7 mm Calibration Kit
- HP 85032B 50 Ω Type-N Calibration Kit
- HP 85036B 75 Ω Type-N Calibration Kit

Test Port Return Cables

The following RF cables are used to return the transmitted signal to the test set in measurement of two-port devices. These cables provide shielding for high dynamic range measurements.

HP 11857D 7 mm Test Port Return cable Set

These are a pair of test port return cables for use with the HP 87511A or HP 85046A S-parameter test sets. The cables can be used in measurements of devices with connectors other than 7 mm by using the appropriate precision adapters.

HP 11857B 75 Ω Type-N Test Port Return Cable Set

These are a pair of test port return cables for use with the HP 87511B or HP 85046B S-parameter test sets.

HP 11851B 50 Ω Type-N RF Cable Set

This kit contains the three phase-matched 50 Ω type-N cables necessary to connect the HP 87512A/B or HP 85044A/B transmission/reflection test kit or a power splitter to the analyzer, as well as an RF cable to return the transmitted signal of a two-port device to the network analyzer. For use with the HP 87512B or HP 85044B test kit, the HP 11852B 50 Ω to 75 Ω minimum loss pad supplied with the test kit must be used for impedance matching with the RF return cable.

Adapter Kits

HP 11852B 50 Ω to 75 Ω Minimum Loss Pad

This device converts impedance from 50 Ω to 75 Ω or from 75 Ω to 50 Ω . It is used to provide a low SWR impedance match between a 75 Ω device under test and the HP 8751A network analyzer or a 50 Ω measurement accessory. An HP 11852B pad is included with the HP 87512B and HP 85044B 75 Ω transmission/reflection test kit. Three HP 11852B pads are included with the HP 11850D 75 Ω power splitter.

These adapter kits contain the connection hardware required for making measurements on devices of the indicated connector type.

- HP 11853A 50 Ω Type-N Adapter Kit
- HP 11854A 50 Ω BNC Adapter Kit
- HP 11855A 75 Ω Type-N Adapter Kit
- HP 11856A 75 Ω BNC Adapter Kit

SYSTEM ACCESSORIES AVAILABLE

System Rack

The HP 85043B system rack is a 124 cm (49 inch) high metal cabinet designed to rack mount the analyzer in a system configuration. The rack is equipped with a large built-in work surface, a drawer for calibration kits and other hardware, a bookshelf for system manuals, and a locking rear door for secured access. Lightweight steel instrument support rails support the instrument along their entire depth. Heavy-duty casters make the cabinet easily movable even with the instruments in place. Screw-down lock feet permit leveling and semi-permanent installation: the cabinet is extremely stable when the lock feet are down. Power is supplied to the cabinet through a heavy-duty grounded primary power cable, and to the individual instruments through special power cables included with the cabinet.

Plotters and Printers

The HP 8751A is capable of plotting displayed measurement results directly to a compatible peripheral without the use of an external computer. The Compatible plotters are:

- HP 7440A Option 002 ColorPro Eight-Pen Color Graphics Plotter, plots on ISO A4 or 8 1/2 × 11 inch charts.
- HP 7475A Option 002 Six-Pen Graphics Plotter, plots on ISO A4/A3 or 8 1/2 × 11 inch or 11 × 17 inch charts.
- HP 7550B Option 002 High-Speed Eight-Pen Graphics Plotter, plots on ISO A4/A3 or 8 1/2 × 11 inch or 11 × 17 inch charts.
- HP 7090A Measurement Plotting System, is a high-performance six-pen programmable digital plotter. It plots on ISO A4/A3 or 8 1/2 × 11 inch or 11 × 17 inch paper or overhead transparency film.

The compatible printers for both printing and plotting are:

- HP 3630A Paintjet Option 002 color printer
- HP 2225A (HP-IB compatible) ThinkJet printer
- HP 2227B QuietJet Option 002 printer

HP-IB Cables

An HP-IB cable is required for interfacing the analyzer with a plotter, printer, computer, or other external instrument. The cables available are HP 10833A (1 m), HP 10833B (2 m), and HP 10833D (0.5 m).

Computer

An external controller is not required for measurement calibration. However, the system can be automated with the addition of the HP 9000 200/300 series computer.

Disks and Disk Accessories

Hewlett-Packard disks are listed below.

Table 1-1. Disks and Disk Accessories

HP Parts Number	Description
92191A	Box of 10 3.5 inch, 270K byte microfloppy disks
92192A	Box of 10 3.5 inch, 720K byte microfloppy disks
92192N	Box of 100 3.5 inch, 720K byte microfloppy disks
92192X	Box of 10 3.5 inch, 1.44M byte microfloppy disks
92191R	Rosewood roll-top disk holder. Holds 50 disks.
92191Q	Acrylic lift-top disk holder. Holds 25 disks.
92191T	Bookshelf-style folding plastic disk holder. Holds 10 disks.
92191H	Disk Library binder. Holds 20 disks initially.

External Monitors

The analyzer can drive both its internal CRT and an external monitor simultaneously. One recommended color monitor is the HP 35741A/B. A monochrome monitor, such as the HP 35731A/B, may also be used if the analyzer is operated in the monochrome mode.

RECOMMENDED TEST EQUIPMENT

Equipment required to test, adjust, and the system is listed in the beginning of the *Maintenance Manual* and the *Service Manual*. Other equipment may be substituted if it meets or exceeds the listed critical specifications.

Instrument Specifications

These specifications are the performance standards or limits against which the instrument is tested. When shipped from the factory, the HP 8751A meets the specifications listed in this section. The specification test procedures are covered in *HP 8751A Maintenance Manual*.

SOURCE

Frequency Characteristics

Range	5 Hz to 500 MHz
Accuracy	
at $23 \pm 5^\circ\text{C}$	$\pm(20 \text{ ppm} + 1 \text{ mHz})$
at 0 to 55°C (with Opt. 001, 20 minutes after power on)	$\pm(1.0 \text{ ppm} + 1 \text{ mHz})$
Stability (at $23 \pm 5^\circ\text{C}$)	
Typical	$\pm 5 \times 10^{-6}/\text{day}$
Typical with Opt. 001, 48 hours after power on	$\pm 2.5 \times 10^{-9}/8 \text{ hours}$
Resolution	1 mHz

Output Power Characteristics

Range	-50 to +15 dBm
Resolution	0.1 dB
Level Accuracy (at $23 \pm 5^\circ\text{C}$, 0 dBm output level, 50 MHz)	$\pm 0.5 \text{ dB}$
Flatness (at $23 \pm 5^\circ\text{C}$, 0 dBm output level relative to 50 MHz)	
$5 \text{ Hz} \leq \text{Freq.} \leq 1 \text{ MHz}$	$\pm 2.0 \text{ dB}$
$1 \text{ MHz} < \text{Freq.} \leq 300 \text{ MHz}$	$\pm 1.5 \text{ dB}$
$300 \text{ MHz} < \text{Freq.} \leq 500 \text{ MHz}$	$\pm 2.0 \text{ dB}$
Linearity (at $23 \pm 5^\circ\text{C}$, relative to 0 dBm output level at 50 MHz)	
Output Level $\geq -35 \text{ dBm}$	$\pm 0.5 \text{ dB}$
Output Level $< -35 \text{ dBm}$	$\pm 1.5 \text{ dB}$
Impedance	
Nominal	50 Ω

Return Loss (at 0 dBm, typical) > 15 dB

Spectral Purity Characteristics

Harmonics (at +10 dBm output level) < -30 dBc

Non-harmonic Spurious Signals (at 0 dBm output level) < -45 dBc

Phase Noise (at 20 kHz offset from 0 dBm fundamental) < -75 dBc/Hz

Sweep Characteristics

Frequency Sweep

Same as the Frequency Characteristics.

Power Sweep

Maximum Span 25 dB to 35 dB

Note The sweep start power is determined by the sweep stop power.



Stop Power Range	Start Power
+5 dBm to +15 dBm	≥ -20 dBm
-5 dBm to +5 dBm	≥ -30 dBm
-15 dBm to -5 dBm	≥ -40 dBm
-50 dBm to -15 dBm	≥ -50 dBm

Resolution 0.1 dB

Linearity (at 23 \pm 5°C, Reference: Stop Power)

Start Power ≥ -45 dBm

	Span $\leq +20$ dB	Span $> +20$ dB
CW Freq. ≤ 300 MHz	$\pm(0.3 \text{ dB}/10 \text{ dB} + 0.2 \text{ dB})$	$\pm(0.3 \text{ dB}/10 \text{ dB} + 1.0 \text{ dB})$
CW Freq. > 300 MHz	$\pm(1.0 \text{ dB}/10 \text{ dB} + 0.2 \text{ dB})$	$\pm(1.0 \text{ dB}/10 \text{ dB} + 1.0 \text{ dB})$

Start Power < -45 dBm

	Span $\leq +20$ dB	Span $< +20$ dB
CW Freq. ≤ 300 MHz	$\pm(0.3 \text{ dB}/10 \text{ dB} + 1.2 \text{ dB})$	$\pm(0.3 \text{ dB}/10 \text{ dB} + 2.0 \text{ dB})$
CW Freq. > 300 MHz	$\pm(1.0 \text{ dB}/10 \text{ dB} + 1.2 \text{ dB})$	$\pm(1.0 \text{ dB}/10 \text{ dB} + 2.0 \text{ dB})$

Others

Reverse Power Protection None (Neither AC nor DC)
Output Connector Type N female, 50 Ω , Single ended

RECEIVER

Input Characteristics

Frequency Range 5 Hz to 500 MHz

Impedance

Nominal 50 Ω

Return Loss

	ATT = 0 dB	ATT = 20 dB
$5 \text{ Hz} \leq \text{Freq.} \leq 100 \text{ MHz}$	> 20 dB	> 25 dB
$100 \text{ MHz} < \text{Freq.} \leq 300 \text{ MHz}$	> 15 dB	> 25 dB
$300 \text{ MHz} < \text{Freq.} \leq 500 \text{ MHz}$	> 10 dB	> 20 dB

Maximum Input Level

	ATT = 0 dB	ATT = 20 dB
$5 \text{ Hz} \leq \text{Freq.} \leq 4 \text{ kHz}$	-26 dBm	-6 dBm
$4 \text{ kHz} < \text{Freq.} \leq 10 \text{ kHz}$	-21 dBm	-1 dBm
$10 \text{ kHz} < \text{Freq.} \leq 500 \text{ MHz}$	-20 dBm	0 dBm

Damage Level

DC $\pm 3 \text{ V}$

At ATT = 0 dB +15 dBm

At ATT = 20 dB +20 dBm

Noise Level (at $23 \pm 5^\circ\text{C}$)

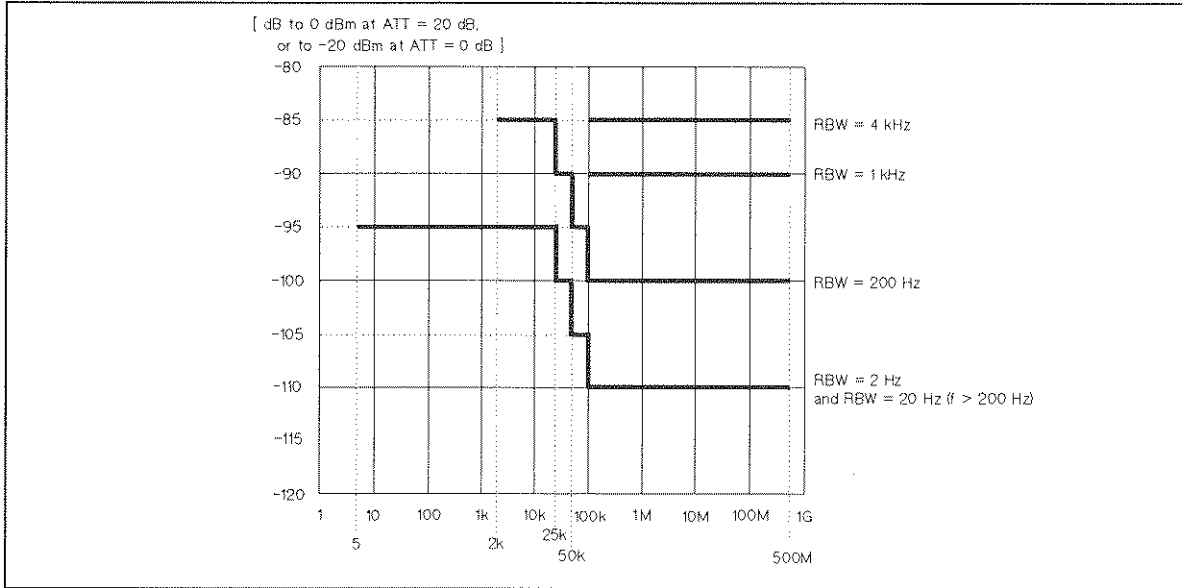

Figure 2-1. Average Noise Level on Magnitude Measurement

IF Bandwidth (IF BW)	2 Hz, 20 Hz, 200 Hz, 1 kHz, and 4 kHz
Input Crosstalk (at the same ATT setting for both input ports)		
Freq. < 10 kHz	< -95 dB
Freq. ≥ 10 kHz	< -100 dB
Source Crosstalk (at +15 dBm output level, ATT = 0 dB)		
Freq. < 10 kHz	< -100 dB
Freq. ≥ 10 kHz	< -135 dB
Input Connector	Type N female, 50 Ω, single ended, 3 inputs (R, A, and B)

Magnitude Characteristics

Absolute Characteristics

Display Range (Ref. value can be set to)	±500 dBm
Display Resolution (/div can be set to)	0.001 dB/div to 500 dB/div
Marker Resolution	0.001 dB or 5 digits
Absolute Amplitude Accuracy (at 23 ±5°C, -30 dBm for ATT = 0 dB, or -10 dBm for ATT = 20 dB)		
Freq. ≤ 300 MHz	±1.0 dB
300 MHz < Freq. ≤ 500 MHz	±1.5 dB
Residual responses (excluding line related and CRT scan related component)		
At ATT = 20 dB	-100 dB to input level 0 dBm

At ATT = 0 dB -100 dB to input level -20 dBm

Ratio Characteristics

Display Range (Ref. value can be set to)..... ±500 dB
 Display Resolution (/div can be set to).....0.001 dB/div to 500 dB/div
 Marker Resolution 0.001 dB or 5 digits
 Ratio Accuracy (at 23 ± 5°C, the same ATT setting for both input ports -10 dB relative to Input Range)
 Freq. ≤ 100 MHz ±0.5 dB
 100 MHz < Freq. ≤ 300 MHz ±1.0 dB
 300 MHz < Freq. ≤ 500 MHz ±1.5 dB

Note Frequency response can be corrected by the calibration.



Dynamic Accuracy (At 23 ± 5°C, 20 Hz bandwidth, Freq. ≥ 1 kHz)

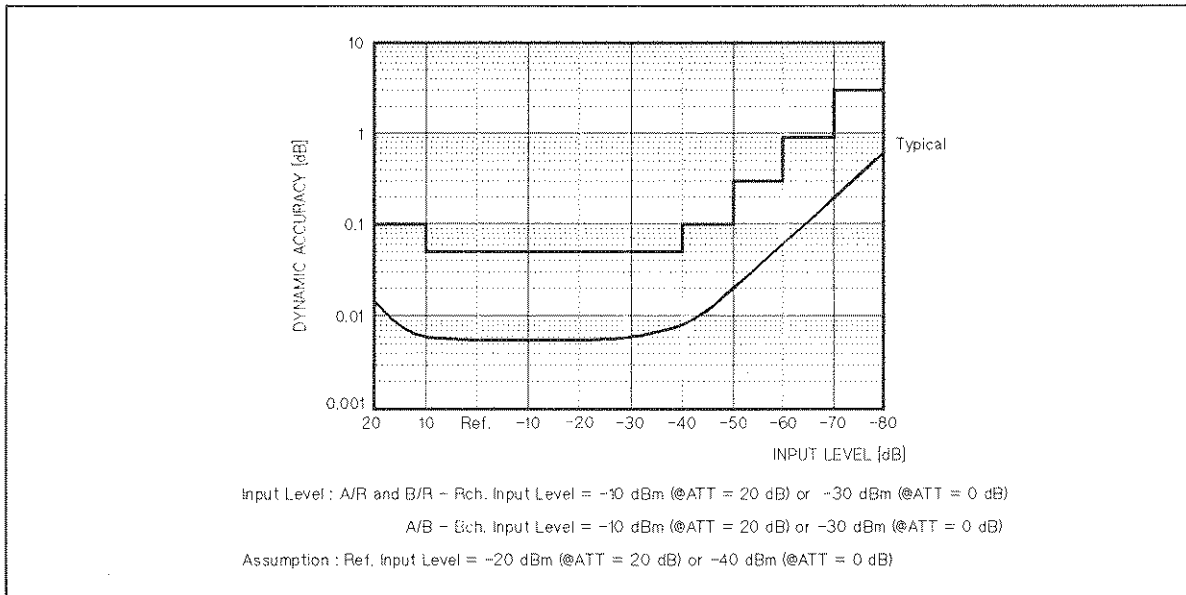

Figure 2-2. Dynamic Accuracy (Amplitude)

Trace Noise (at 1 kHz bandwidth, -10 dB full-scale, Freq. ≥ 100 kHz) < 10 mdB rms
 Stability 0.02 dB/°C

Phase Characteristics

Measurement Mode Normal/Expanded
 Measurement Range

Normal mode	± 100 kdeg (no radian unit available)
Expanded mode	± 5 Mdeg
Display Resolution	10^{-4} deg/div to 10 kdeg/div
Marker Resolution	
Normal mode	0.01 deg. or 5 digits
Expanded mode	5 digits
Frequency Response (at $23 \pm 5^\circ\text{C}$, deviation from linear phase, input level -10 dBm (ATT = 20 dB) or -30 dBm (ATT = 0 dB), ATTs are the same setting)	
Freq. ≤ 100 MHz	± 2.5 degree
100 MHz $<$ Freq. ≤ 300 MHz	± 5.0 degree
300 MHz $<$ Freq. ≤ 500 MHz	± 10.0 degree

Note



This specification is only for the deviation from linear phase. Frequency response can be corrected by calibration.

Dynamic Accuracy (at $23 \pm 5^\circ\text{C}$, 20 Hz bandwidth, Freq. ≥ 1 kHz)

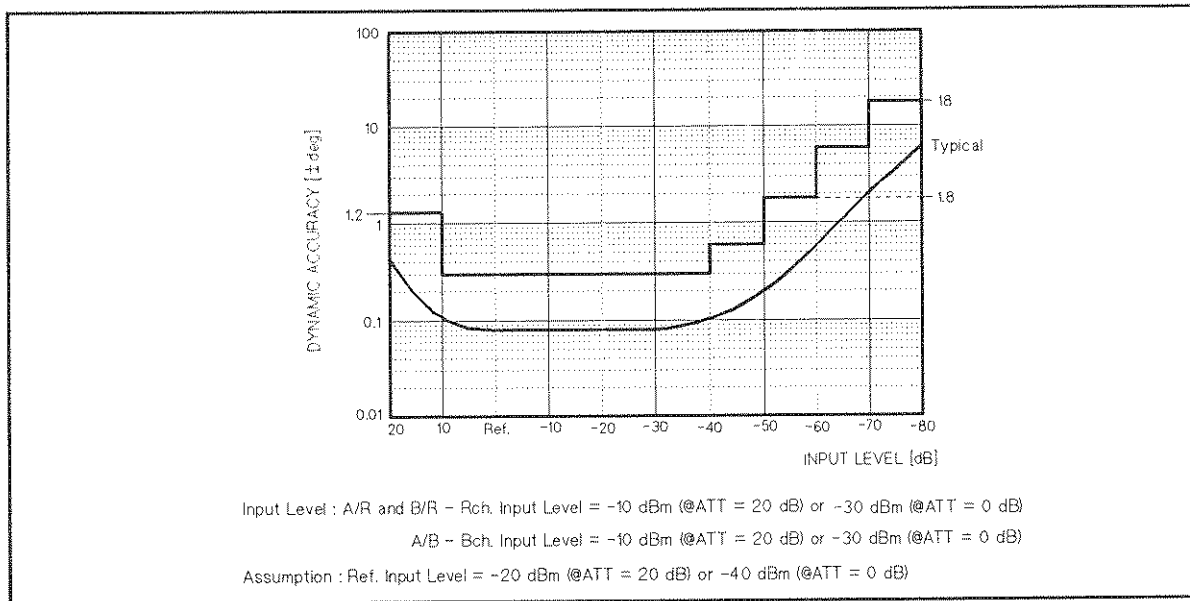

Figure 2-3. Dynamic Accuracy (Phase)

Trace Noise (at Freq. ≥ 100 kHz, 1 kHz bandwidth, input level -10 dBm (ATT = 20 dB) or -30 dBm (ATT = 0 dB)	50 mdeg rms
Stability	0.05 deg/ $^\circ\text{C}$

Delay Characteristics

Aperture Frequency	$\frac{200}{N-1}$ % to 100% of span, where N is Number of Points
Display Range (Ref. value can be set to)	± 10 psec to ± 0.5 sec
Display Resolution (/div can be set to)	10 fsec/div to 10 sec/div
Accuracy (at = 23 $\pm 5^\circ$ C)	

In general, the following formula can be used to determine the accuracy, in seconds, of a specific group delay measurement:

$$\frac{\text{Phase Accuracy}[\text{deg}]}{360[\text{deg}] \times \text{Aperture}[\text{deg}]}$$

Depending on the aperture, input level, and device length, the phase accuracy used in either incremental phase accuracy or worst case phase accuracy.

DC Voltage Measurement Characteristics for INPUT B

Range	± 2 Vdc
Accuracy	$\pm (0.5 \% + 5 \text{ mV})$
Damage Level	± 3 Vdc

GENERAL CHARACTERISTICS

Operating Conditions

When disk drive is in operation

Temperature

Temperature	10 to 50 °C
-------------------	-------------

Humidity (at wet bulb $\leq 29^\circ\text{C}$, without condensation)

Humidity (at wet bulb $\leq 29^\circ\text{C}$, without condensation)	$15\% \leq \text{RH} \leq 80\%$
---	---------------------------------

When disk drive is not in operation

Temperature

Temperature	0 to 55 °C
-------------------	------------

Humidity (at wet bulb $\leq 29^\circ\text{C}$, without condensation)

Humidity (at wet bulb $\leq 29^\circ\text{C}$, without condensation)	$15\% \leq \text{RH} \leq 95\%$
---	---------------------------------

Altitude

Altitude	0 to 4,500 meters (15,000 feet)
----------------	---------------------------------

Warm Up Time

Warm Up Time	30 minutes
--------------------	------------

Non-operating Conditions

Temperature

Temperature	-40 to 60 °C
-------------------	--------------

Humidity (at wet bulb $\leq 29^\circ\text{C}$, without condensation)

Humidity (at wet bulb $\leq 29^\circ\text{C}$, without condensation)	$15\% \leq 95\%$
---	------------------

Altitude 0 to 15,240 meters (50,000 feet)

Probe Power

Probe Power	+15 V (300 mA), -12.6 V (160 mA), GND
-------------------	---------------------------------------

Safety

Safety	Based on IEC-348, UL 1244 certified by CSA 556B
--------------	---

EMI

EMI	Based on FTZ 526/527
-----------	----------------------

Line Power

Voltage Selector	Line Voltage	Line Frequency	MAX. VA
115 V	90 to 132 V	47 to 66 Hz	350
230 V	198 to 264 V	47 to 66 Hz	350

Weight 28 kg (Typ.)

Cabinet Dimensions 425(W) × 235(H) × 553(D) mm (Typ.)

REAR PANEL SPECIFICATIONS

I/O Buses

HP-IB Interface

ANSI/IEEE 488.2 compatible. There is no address switch.

S-Parameter Test Set Interface

Figure 2-4 shows pin assignments of the S-parameter test set interface.

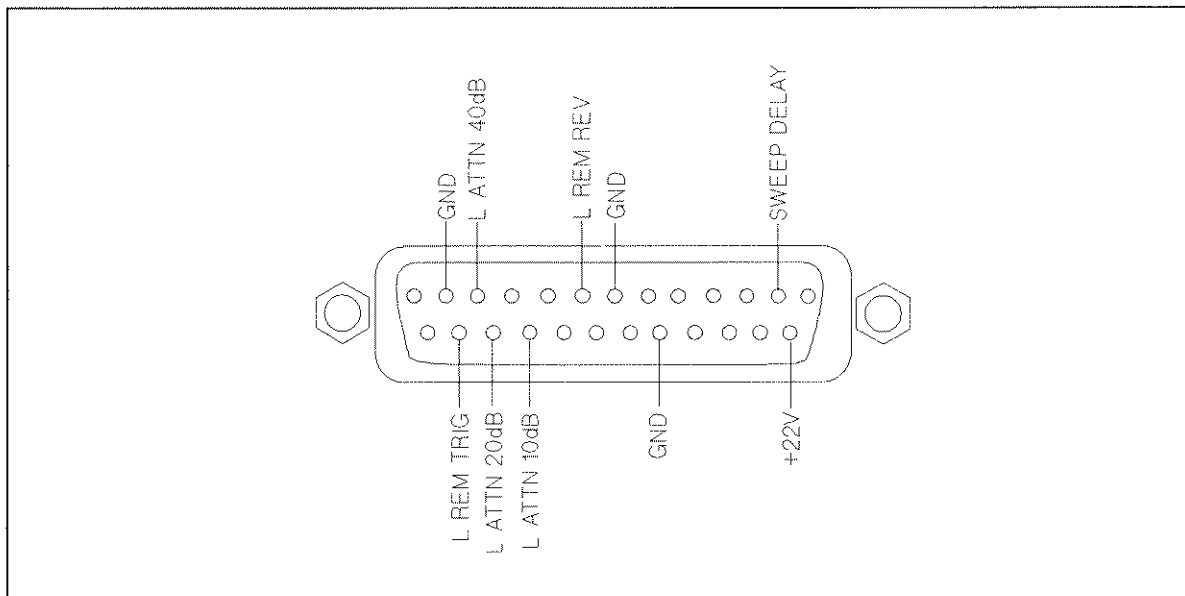

C2102005

Figure 2-4. S-Parameter Test Set Interface Pin Assignments

The HP part number for the connection cable is 08503-60051.

2-8 Instrument Specifications

I/O Port

See Appendix C in the *Reference Manual*.

BNC Connectors

“EXT REF INPUT 10/N MHz” Connector

This inputs a frequency reference to phase lock the analyzer to an external frequency standard.

Applicable input signal is:

Frequency	$\frac{10}{N}$ MHz ± 10 ppm, (N=1,2,5,10)
Amplitude	0 ± 5 dBm
Nominal Impedance	50 Ω

“REF OVEN (OPTION 001)” Connector

This outputs a frequency standard if Option 001 is installed. Output signal specifications follow:

Frequency	10 MHz ± 1.0 ppm
Amplitude	0 ± 5 dBm
Nominal Impedance	50 Ω

“INT REF OUTPUT” Connector

This outputs a frequency reference to an external instrument to phase lock it to the analyzer.

Output signal specifications follow:

Frequency	10 MHz ± 20 ppm
Amplitude	0 ± 5 dBm
Nominal Impedance	50 Ω

“EXT TRIGGER” Connector

This triggers a measurement sweep.

Trigger signal specifications follow (refer to Figure 2-5):

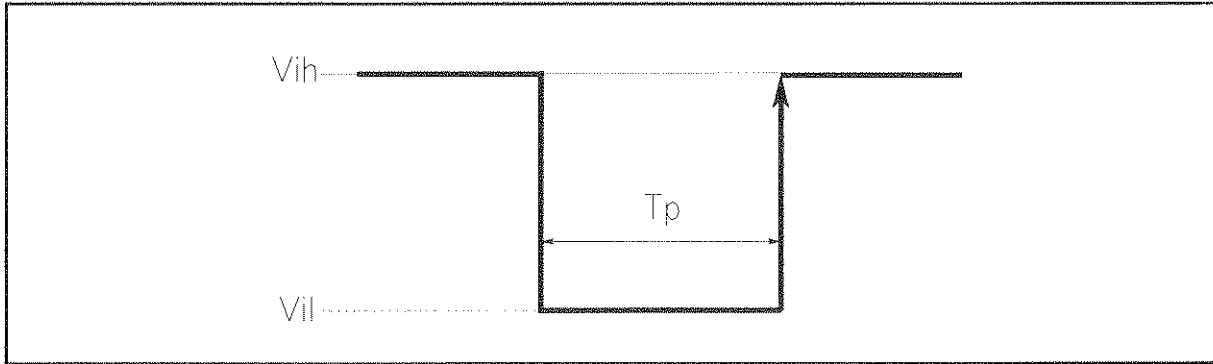

C2102006

Figure 2-5. Trigger Signal

- V_{ih} +2 V to +5 V
- V_{il} 0 V to +0.5 V
- Sink current (I_s) $I_s \leq 0.4$ mA
- Pulse width (T_p) $T_p \geq 20$ μ sec
- Positive edge trigger

“EXT PROG RUN/CONT” Connector

This externally triggers RUN/CONT of the Instrument BASIC program. The signal specifications are the same with the “EXT TRIGGER” connector.

“EXT MONITOR” Connectors

These drive an external monitors. The signal specifications follow:

- Output level 0 to 0.714 V
- H-sync. signal mixed in “G” signal

FURNISHED ACCESSORIES

Accessory	HP part number
Operation Manual	08751-90000
Maintenance Manual	08751-90030
Floppy Disk	9164-0299
Power Cable ¹	
BNC Adapter ²	1250-1859

¹ power cable depends on where is the instrument used, see figure on the next page

² Only option 001.

<p>OPTION 900 United Kingdom</p>  <p>Plug : BS 1363A, 250V Cable : HP 8120-1351</p>	<p>OPTION 901 Australia/New Zealand</p>  <p>Plug : NZSS 198/AS C112, 250V Cable : HP 8120-1369</p>
<p>OPTION 902 European Continent</p>  <p>Plug : CEE-VII, 250V Cable : HP 8120-1689</p>	<p>OPTION 903 U.S./Canada</p>  <p>Plug : NEMA 5-15P, 125V, 15A Cable : HP 8120-1378</p>
<p>OPTION 904 U.S./Canada</p>  <p>Plug : NEMA 6-15P, 250V, 15A Cable : HP 8120-0698</p>	<p>OPTION 905* Any country</p>  <p>Plug : CEE 22-VI, 250V Cable : HP 8120-1396</p>
<p>OPTION 906 Switzerland</p>  <p>Plug : SEV 1011.1959-24507 Type 12, 250V Cable : HP 8120-2104</p>	<p>OPTION 912 Denmark</p>  <p>Plug : DHCR 107, 220V Cable : HP 8120-2956</p>
<p>OPTION 917 India/Republic of S.Africa</p>  <p>Plug : SABS 164, 250V Cable : HP 8120-4211</p>	<p>OPTION 918 Japan</p>  <p>Plug : JIS C 8303, 125V, 15A Cable : HP 8120-4753</p>
<p>NOTE: Each option number includes a 'family' of cords and connectors of various materials and plug body configurations (straight, 90° etc.).</p> <p>* Plug option 905 is frequently used for interconnecting system components and peripherals.</p>	

Figure 2-6. Power Cables Supplied

TYPICAL SYSTEM PERFORMANCE

Introduction

The performance of a network analyzer system depends not only on the performance of the individual instruments, but also on the system configuration, the user-selected operating conditions, and the measurement calibration.

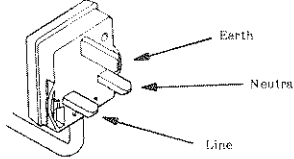
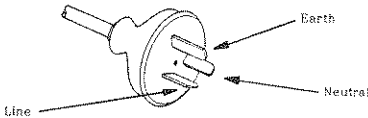
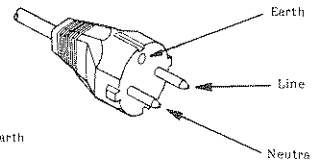
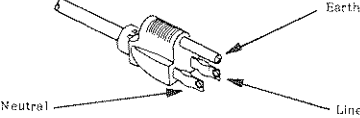
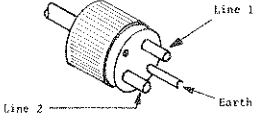
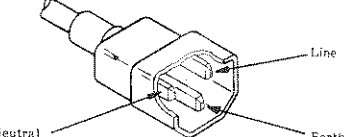
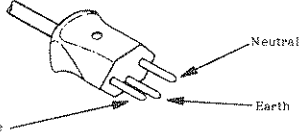
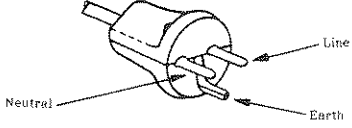
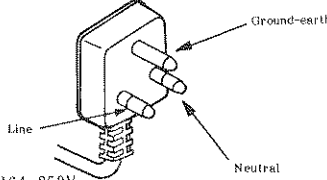
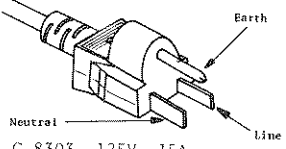
This section explains the residual errors remaining in a measurement system after accuracy enhancement. It provides information to calculate the total measurement uncertainty of different systems. Graphs at the beginning of the section show examples of the performance that can be calculated using the methods in this section.

The sources of measurement errors are explained, with an error model flowgraph and uncertainty equations. Information is provided for conversion of the dynamic accuracy error (in dB) to a linear value for use in the uncertainty equations. The effects of temperature drift on measurement uncertainty are illustrated with graphs.

Procedure and blank worksheets are supplied to compute the total error-corrected measurement uncertainty of a system. These procedures combine the terms in the tables, the uncertainty equation, and the nominal S-parameter data of the device under test.

Comparison Of Typical Error-Corrected Measurement Uncertainty

Figure 2-7 through Figure 2-14 are examples of the measurement uncertainty data that can be calculated using the information provided in this section. These figures compare the reflection and transmission measurement uncertainty of a 7 mm system using different levels of error correction. Each figure shows uncorrected values and residual uncertainty values after full two port calibration. The data applies to a frequency range of 100 kHz to 500 MHz with a stable temperature (no temperature drift), using compatible 7 mm calibration devices from the HP 85031B calibration kit, and setting the attenuators in input port A and B of the HP 8751A to 20 dB.

The results graphed in Figure 2-7 through Figure 2-14 can be obtained using the HP 87511A. Different measurement calibration procedures provide comparable measurement improvement or the following compatible connector types and test sets (using the compatible calibration kits):

- HP 87511A with option 001 50 Ω type-N connectors
- HP 87511B 75 Ω type-N connectors

Reflection Uncertainty of a One-Port Device

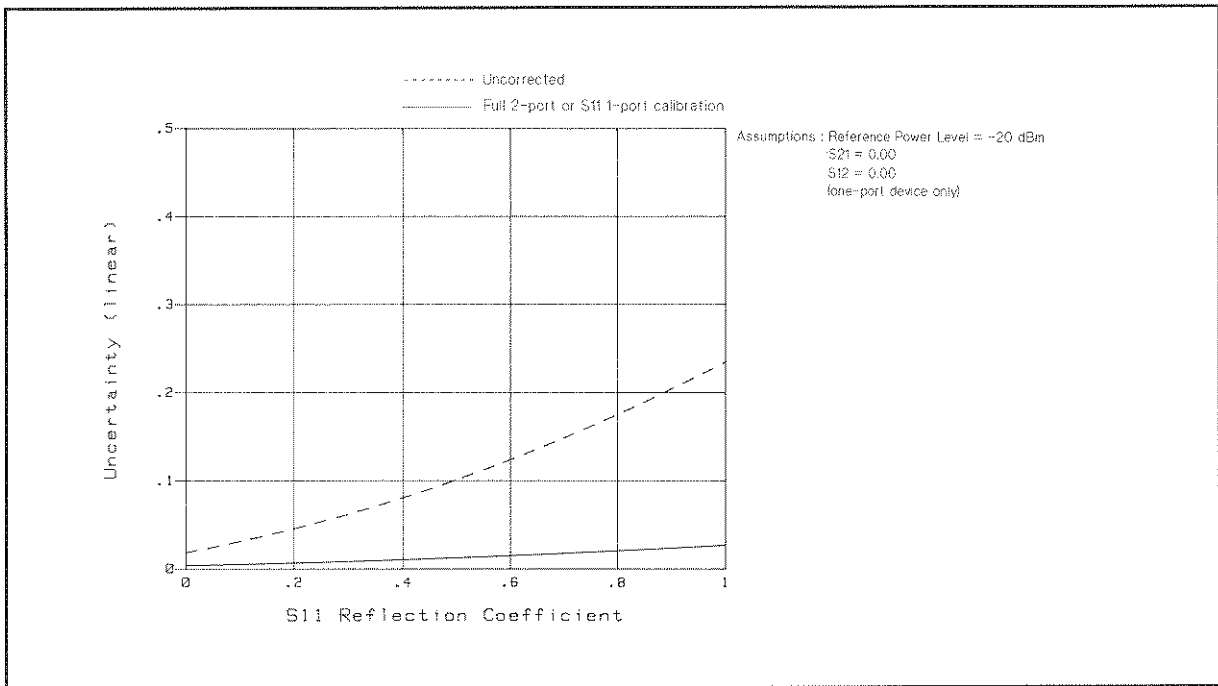

Figure 2-7. Total Reflection Magnitude Uncertainty

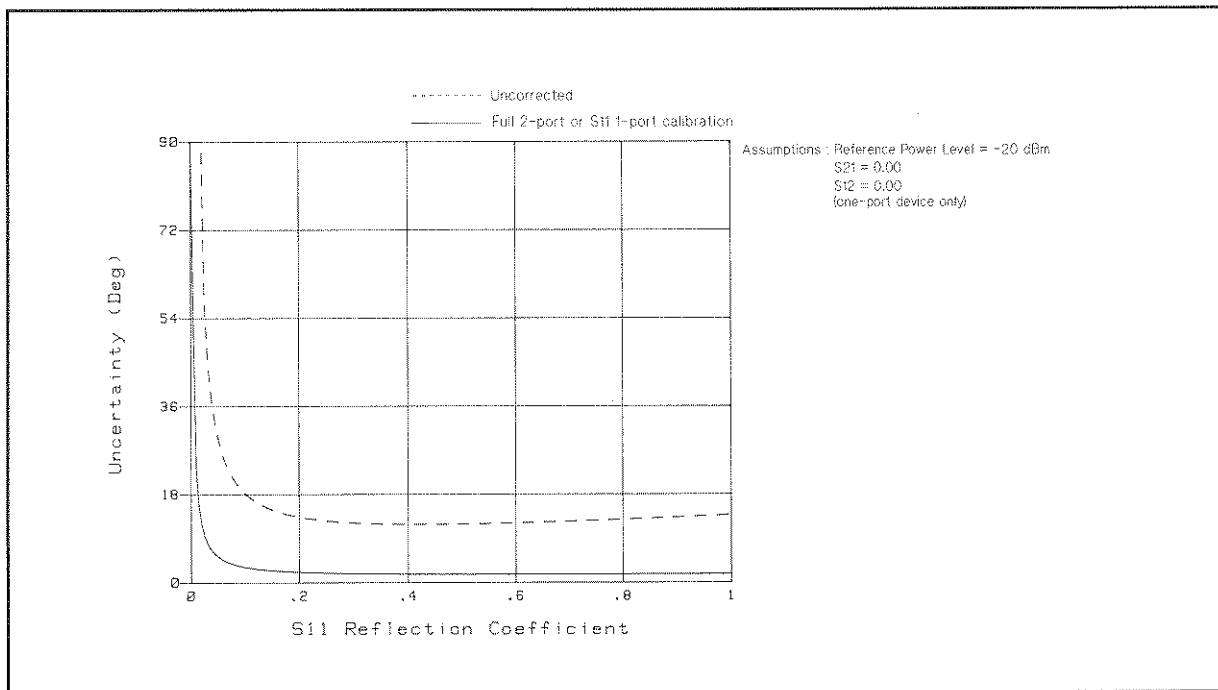

Figure 2-8. Total Reflection Phase Uncertainty

Reflection Uncertainty of a Two-Port Device

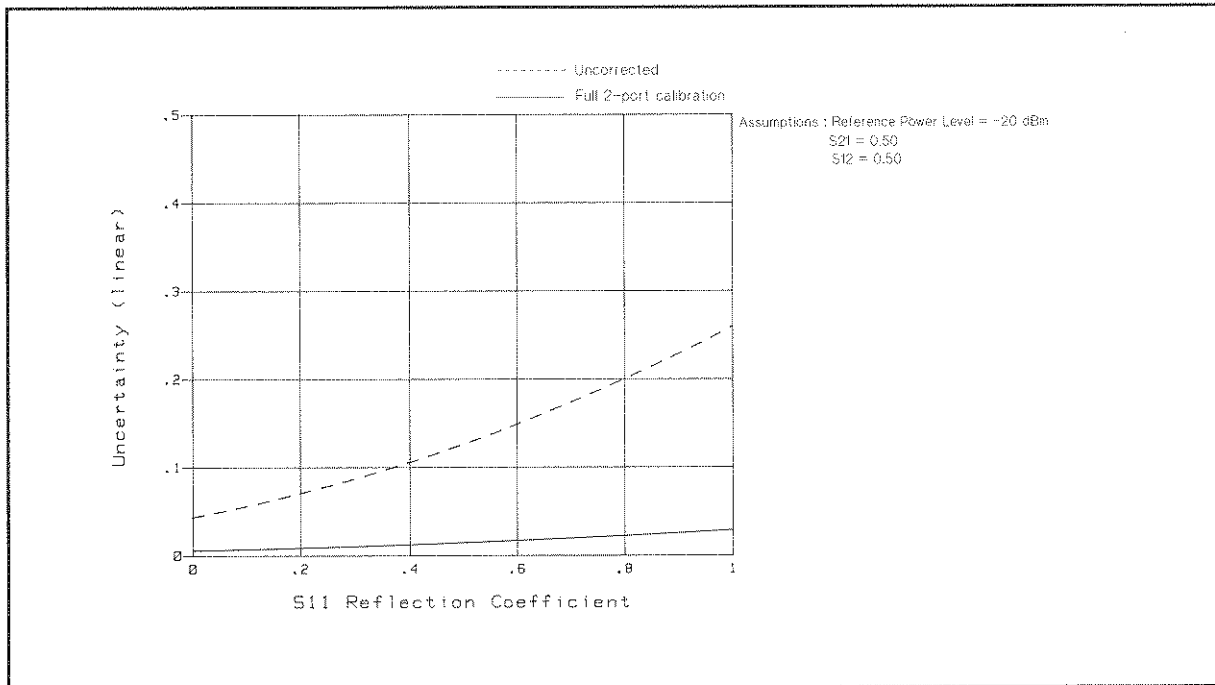

Figure 2-9. Total Reflections Magnitude Uncertainty

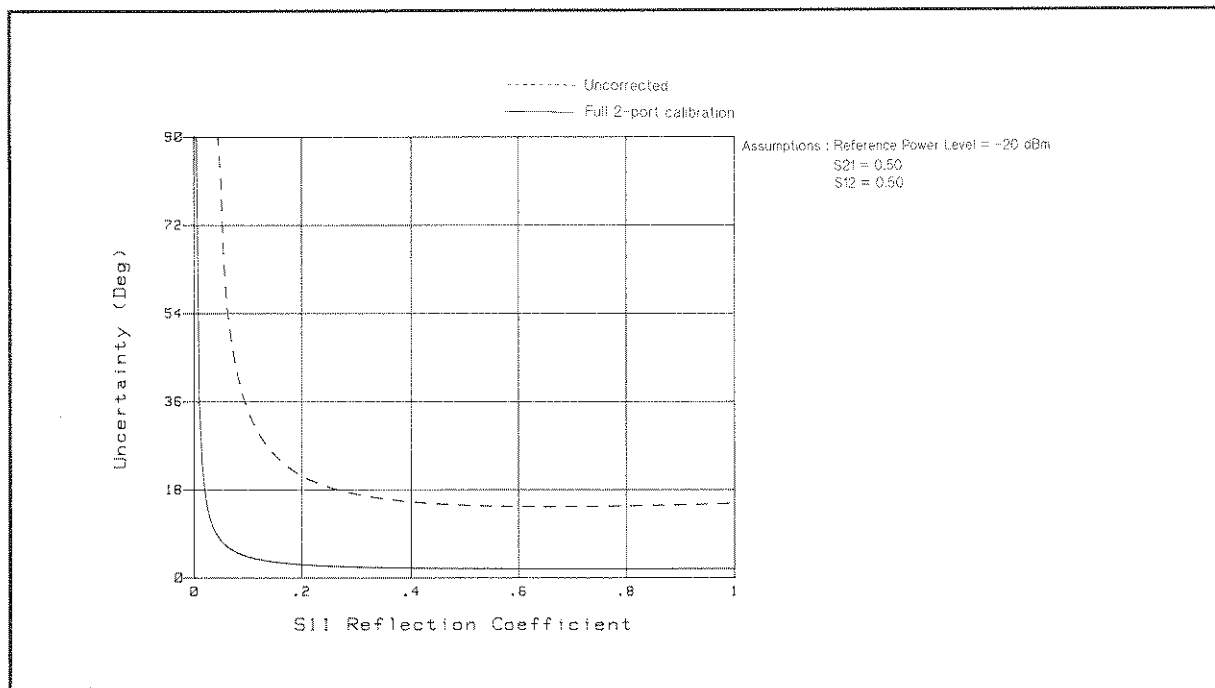

Figure 2-10. Total Reflection Phase Uncertainty

Transmission Uncertainty of a Low-Loss Device

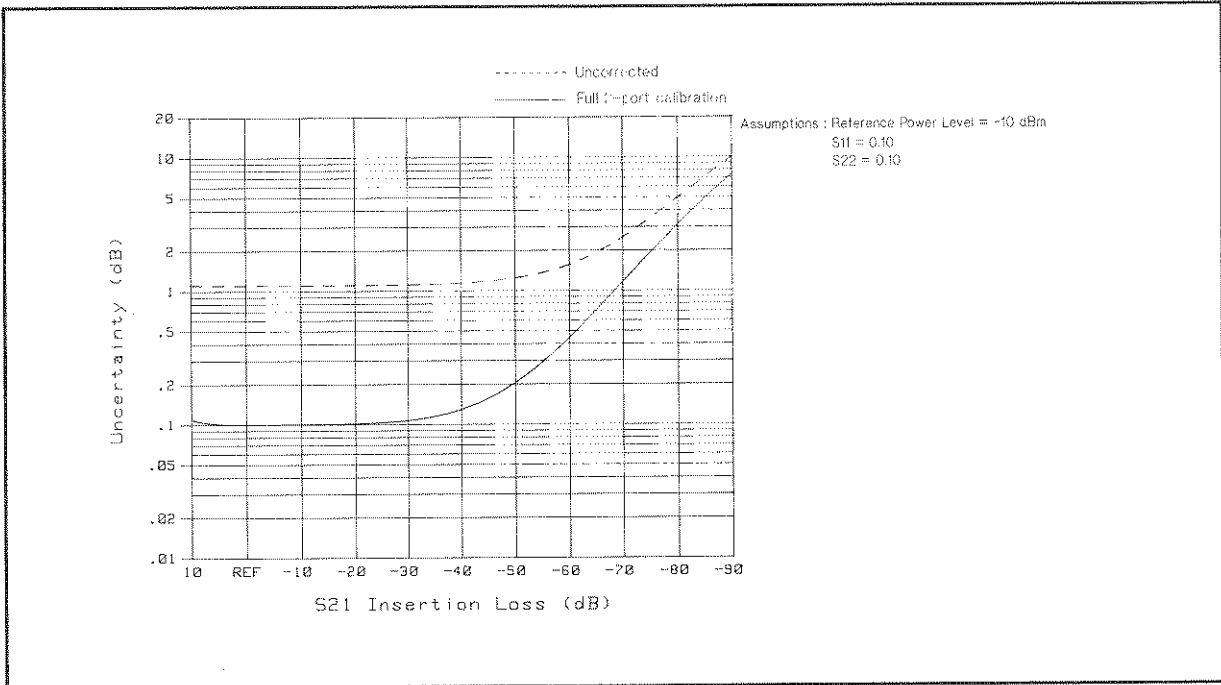

Figure 2-11. Total Transmission Magnitude Uncertainty

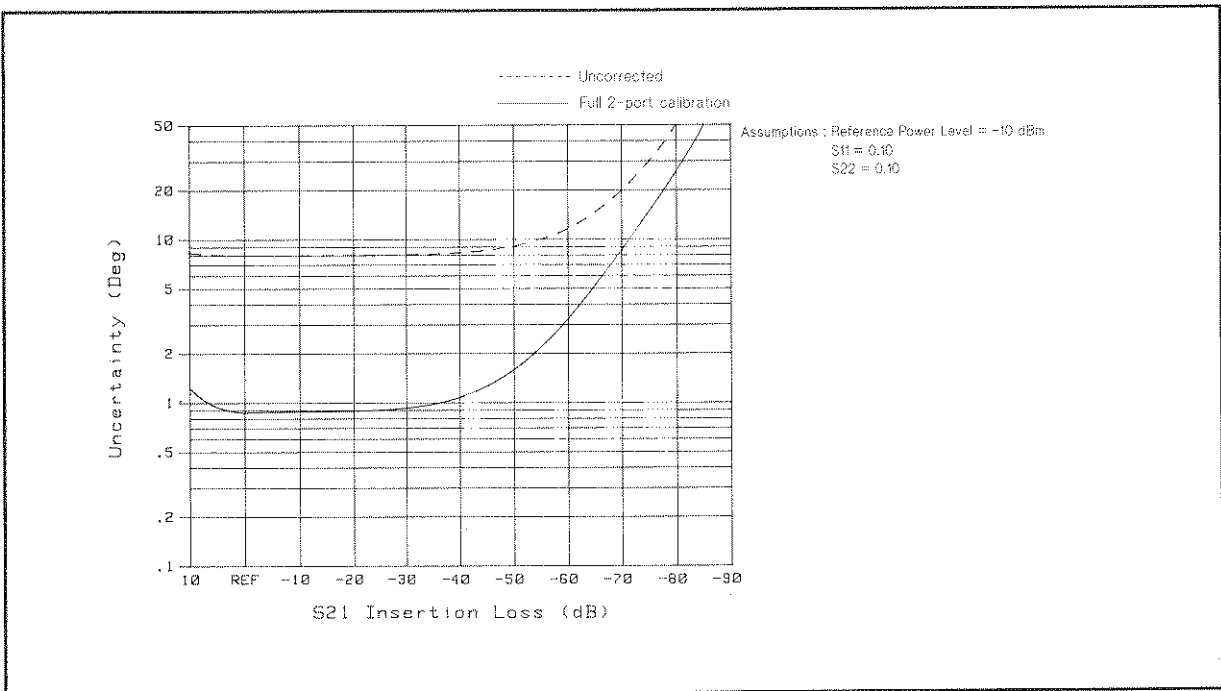

Figure 2-12. Total Transmission Phase Uncertainty

Transmission Uncertainty of a Wide Dynamic Range Device

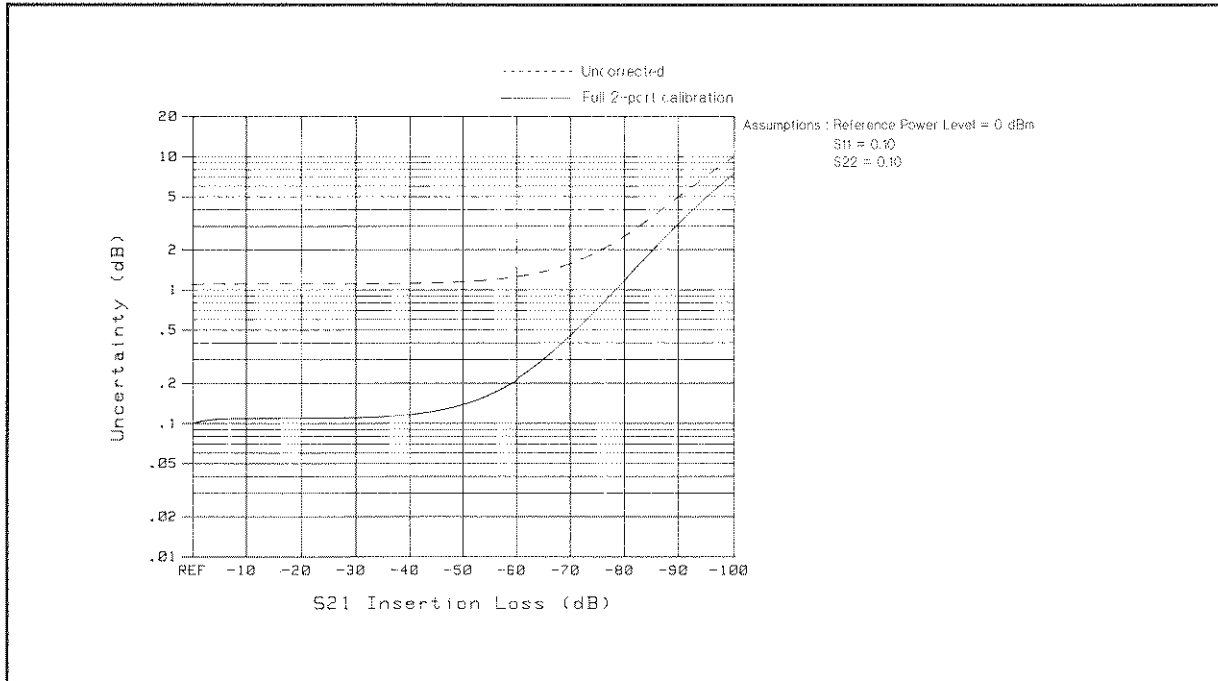

Figure 2-13. Total Transmission Magnitude Uncertainty

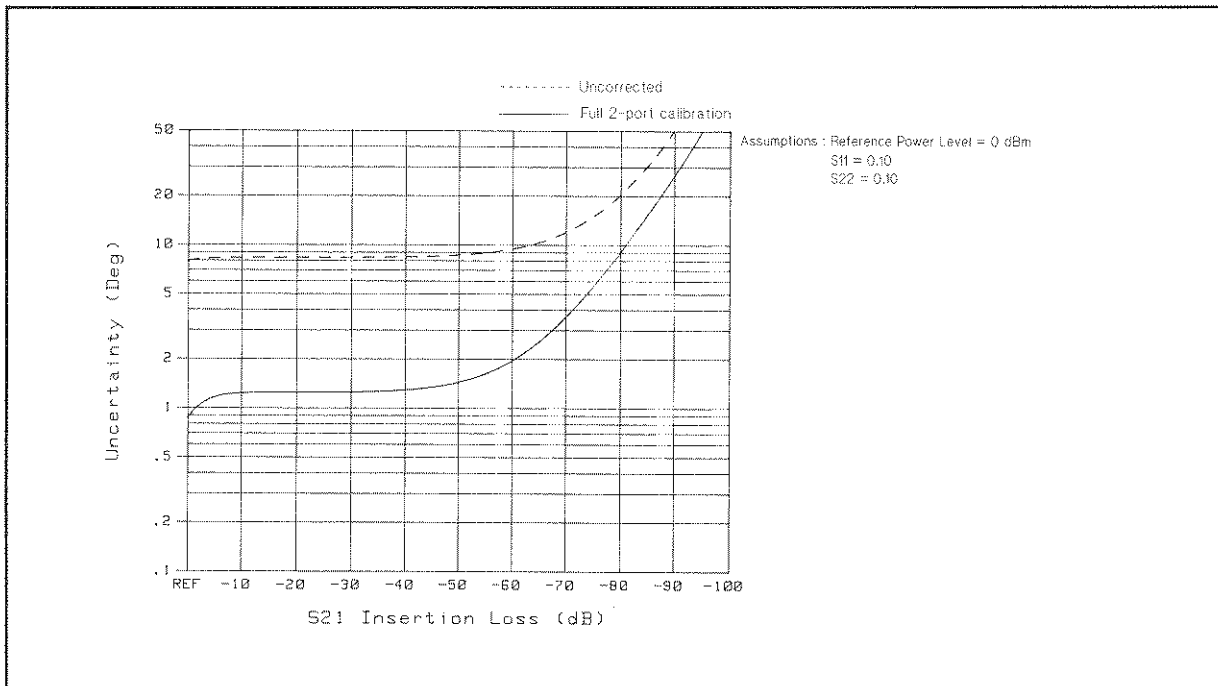

Figure 2-14. Total Transmission Phase Uncertainty

TYPES OF RESIDUAL MEASUREMENT ERRORS

Network analysis measurement errors can be separated into three types: systematic, random, and drift errors. Measurement errors that remain after measurement calibration are called residual measurement errors. See "Measurement Calibration" in the *Reference Manual*, for a detailed description of the systematic errors corrected by measurement calibration.

Residual Systematic Errors

These errors result from imperfections in the calibration standards, connector standards and interface, interconnecting cables, and instrumentation. These are the errors that affect transmission and reflection measurements.

Transmission Measurements	Reflection Measurements
Dynamic Accuracy Effective Switch port match Switch tracking Frequency error	
Effective crosstalk Effective load match Effective transmission tracking Cable stability	Effective directivity Effective source match Effective reflection tracking

Residual Random Errors

These non-repeatable errors are due to trace noise, noise floor, and connector repeatability. They affect both transmission and reflection measurements.

Residual Drift Errors

These errors stem from frequency drift and instrumentation drift. They affect both kinds of measurements. Instrumentation drift is primarily temperature related.

SYSTEM ERROR MODE

Any measurement result is the vector sum of the actual test device response plus all error terms. The precise effect of each error term depends upon its magnitude and phase relationship to the actual test device response. When the phase of an error response is not known, phase is assumed to be worst case (0 or 180 degrees). Random errors such as noise and connector repeatability are generally combined in a root-sum-of the squares (RSS) manner. The error term related to thermal drift is combined on a worst-case basis as shown in each uncertainty equation given in the following paragraphs.

Figure 2-15 shows the error model for the analyzer with the HP 87511A/B S-parameter test set. This error model shows the relationship of the various error sources in the forward direction, and may be used to analyze overall measurement performance. The model for signal flow in the reverse direction is similar. Note the appearance of the dynamic accuracy, noise errors, switch errors, and connector repeatability terms in both the reflection and transmission portions of the model.

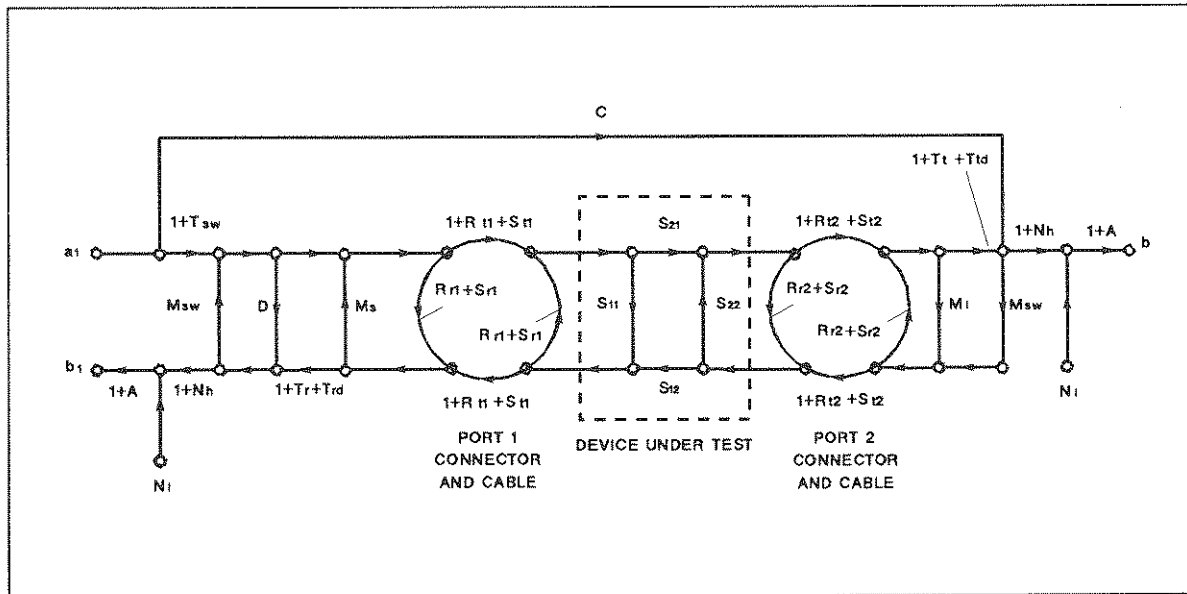

Figure 2-15. HP 8751A/87511A System Error Model

Table 2-1. Parameters of System Error Model

A	= Dynamic Accuracy (A_m = Magnitude Dynamic Accuracy) (A_p = Phase Dynamic Accuracy)	D	= Residual Directivity
N₁	= Noise Floor	M_s	= Residual Source Match
N_h	= High Level Noise	M₁	= Residual Load Match
T_{sw}	= Switch Tracking	C	= Residual Crosstalk
M_{sw}	= Switch Port Match	T_r	= Residual Reflection Tracking
R_{r1}	= Port 1 Reflection Repeatability	T_t	= Residual Transmission Tracking
R_{r2}	= Port 2 Reflection Repeatability	S_{r1}	= Port 1 Cable Reflection Stability
R_{t1}	= Port 1 Transmission Repeatability	S_{r2}	= Port 2 Cable Reflection Stability
R_{t2}	= Port 2 Transmission Repeatability	S_{t1}	= Port 1 Cable Transmission Stability
T_{rd}	= Reflection Tracking Drift	S_{t2}	= Port 2 Cable Transmission Stability
T_{td}	= Transmission Tracking Drift		

For measurement of one-port devices, set the crosstalk (C), load match (M₁), transmission tracking (T_t), port 2 connector repeatability (R_{r2}, R_{t2}), and port 2 cable stability (S_{r2}, S_{t2}) error terms to zero.

REFLECTION UNCERTAINTY EQUATIONS

Total Reflection Magnitude Uncertainty (E_{rm})

An analysis of the error model yields an equation for the reflection magnitude uncertainty. The equation contains all of the first order terms and the significant second order terms. The error term related to thermal drift is combined on a worst case basis with the total of systematic and random errors. The four terms under the radical are random in character and are combined on an RSS basis. The terms in the systematic error group are combined on a worst case basis. In all cases, the error terms and the S-parameters are treated as linear absolute magnitudes.

$$E_{rm(\text{linear})} = V_r + S_{11} T_{rd(\text{magnitude})}$$

and

$$E_{rm(\text{log})} = 20 \log \left(1 \pm \frac{E_{rm}}{S_{11}} \right)$$

where

$$V_r = S_r + \sqrt{W_r^2 + X_r^2 + Y_r^2 + Z_r^2}$$

S_r = systematic error

$$= (1 + T_{sw})(D + S_{r1}) + (T_{sw} + T_r)S_{11} + (M_{sw} + M_s + S_{r1})S_{11}^2 + M_1 S_{21} S_{12} + A_m S_{11}$$

W_r = random low-level noise

$$= 3N_l$$

X_r = random high-level noise

$$= 3N_h S_{11}$$

Y_r = random port1 repeatability

$$= R_{r1} + 2R_{t1} S_{11} + R_{r1} S_{11}^2$$

Z_r = random port2 repeatability

$$= R_{r2} S_{21} S_{12}$$

Total Reflection Phase Uncertainty (E_{rp})

Reflection phase uncertainty is determined from a comparison of the magnitude uncertainty with the test signal magnitude. The worst case phase angle is computed. This result is combined with the error terms related to thermal drift of the total system, port 1 cable stability, and phase dynamic accuracy.

$$E_{rp} = \arcsin \left(\frac{V_r - A_m S_{11}}{S_{11}} \right) + T_{rd(\text{phase})} + 2S_{t1} + A_p$$

TRANSMISSION UNCERTAINTY EQUATIONS

Total Transmission Magnitude Uncertainty (E_{tm})

An analysis of the error model in Figure 2-15 yields an equation for the transmission magnitude uncertainty. The equation contains all of the first order terms and some of the significant second order terms. The error term related to thermal drift is combined on a worst case basis with the total of systematic and random errors. The four terms under the radical are random in character and are combined on an RSS basis. The terms in the systematic error group are combined on a worst case basis. In all cases, the error terms are treated as linear absolute magnitudes.

$$E_{tm(\text{linear})} = V_t + S_{21} T_{td(\text{magnitude})}$$

and

$$E_{tm(\text{log})} = 20 \log \left(1 \pm \frac{E_{tm}}{S_{21}} \right)$$

where

$$V_t = S_t + \sqrt{W_t^2 + X_t^2 + Y_t^2 + Z_t^2}$$

S_t = systematic error

$$= C + (T_{sw} + T_t)S_{21} + (M_{sw} + M_s + S_{r1})S_{11}S_{21} + (M_{sw} + M_I + S_{r2})S_{21}S_{22} + A_m S_{21}$$

W_t = random low-level noise

$$= 3N_l$$

X_t = random high-level noise

$$= 3N_h S_{21}$$

Y_t = random port1 repeatability

$$= R_{t1} S_{21} + R_{r1} S_{11} S_{21}$$

Z_t = random port2 repeatability

$$= R_{t2} S_{21} + R_{r2} S_{22} S_{21}$$

Total Transmission Phase Uncertainty (E_{tp})

Transmission phase uncertainty is calculated from a comparison of the magnitude uncertainty with the test signal magnitude. The worst case phase angle is computed. This result is combined with the error terms related to phase dynamic accuracy, cable phase stability, and thermal drift of the total system.

$$E_{tp} = \arcsin \left(\frac{V_t - A_m S_{21}}{S_{21}} \right) + T_{td(\text{phase})} + S_{t1} + S_{t2} + A_p$$

DYNAMIC ACCURACY

The dynamic accuracy value used in the system uncertainty equations is obtained for the analyzer's dynamic accuracy specifications. The specification for magnitude dynamic accuracy is in dB, and it must be converted to a linear value to be used in the UNCERTAINTY equations. In addition, the HP 8751A's dynamic accuracy specifications are given for an absolute input signal in dBm, and must be converted to a relative error (relative to the power at which the measurement calibration occurs) to be used in the system uncertainty equations.

$$\text{Dynamic Accuracy (linear)} = 10^{\frac{\pm \text{DynAcc(dB)}}{20}} \mp 1$$

$$\text{Dynamic Accuracy (dB)} = 20 \log(1 \pm \text{Dynamic Accuracy (linear)})$$

Definitions

P_{cal} = the calibration (thus the reference) power level at the instrument input port (A or B) (i.e. when the short is measured in a reflection calibration OR when the thru is measured in a transmission calibration)

P_{meas} = the measured input signal (dBm) when the DUT is measured

Residual dynamic accuracy = the residual error remaining when P_{meas} is equal to P_{cal}

Linacc = relative dynamic accuracy (linear magnitude or phase) for the ratioed measurement used in the linear system performance calculation

Lincal = dynamic accuracy (linear magnitude or phase) term for single input at P_{cal}

Linmeas = dynamic accuracy (linear magnitude or phase) term for single input at P_{meas}

Determining Relative Dynamic Accuracy Error Contribution

The example given here shows how to determine the relative dynamic accuracy error contribution to a measurement in a ratio mode. Six example graphs are provided: Figure 2-16 and Figure 2-17 show the worst-case magnitude and phase dynamic accuracy error with a reference power level of 0 dBm, Figure 2-18 and Figure 2-19 with a reference power level of -20 dBm, and Figure 2-20 and Figure 2-21 with a reference power level of -60 dBm.

Table 2-2 shows the equations used to determine the relative dynamic accuracy error contribution, when assuming the R channel input power level is constant during calibration and when measuring a DUT.

Table 2-2. Determining Relative Dynamic Accuracy (Linacc)

P_{cal}	0 dBm $\geq P_{\text{cal}} \geq$ -40 dBm		-40 dBm $> P_{\text{cal}} >$ -100 dBm
P_{meas}	0 dBm $\geq P_{\text{meas}} \geq$ -40 dBm	-40 dBm $\geq P_{\text{meas}} \geq$ -100 dBm	0 dBm $\geq P_{\text{meas}} \geq$ -100 dBm
Linacc	ABS(Lincal - Linmeas) + Residual ^{1,2}	Lincal + Linmeas - Residual ^{1,2}	Lincal + Linmeas

1 Residual Magnitude Dynamic Accuracy (linear) = 0.000645

2 Residual Phase Dynamic Accuracy = 0.08°

Dynamic Accuracy Error Contribution

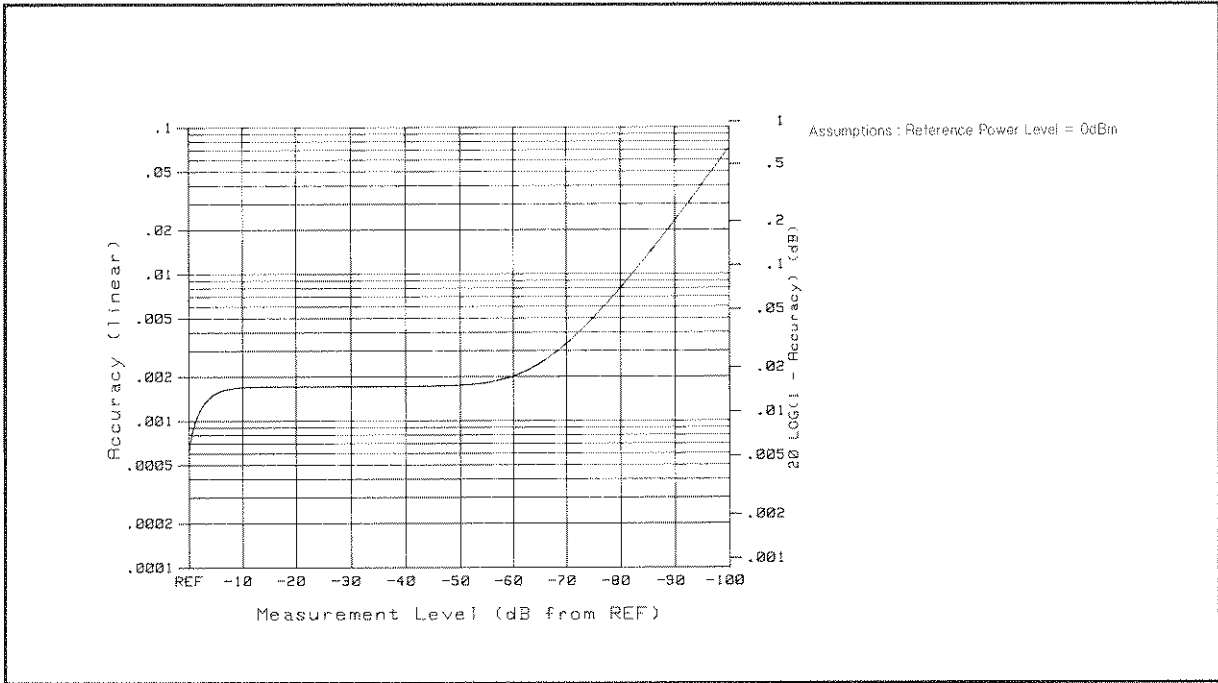

Figure 2-16. Worst-Case Magnitude Dynamic Accuracy Error

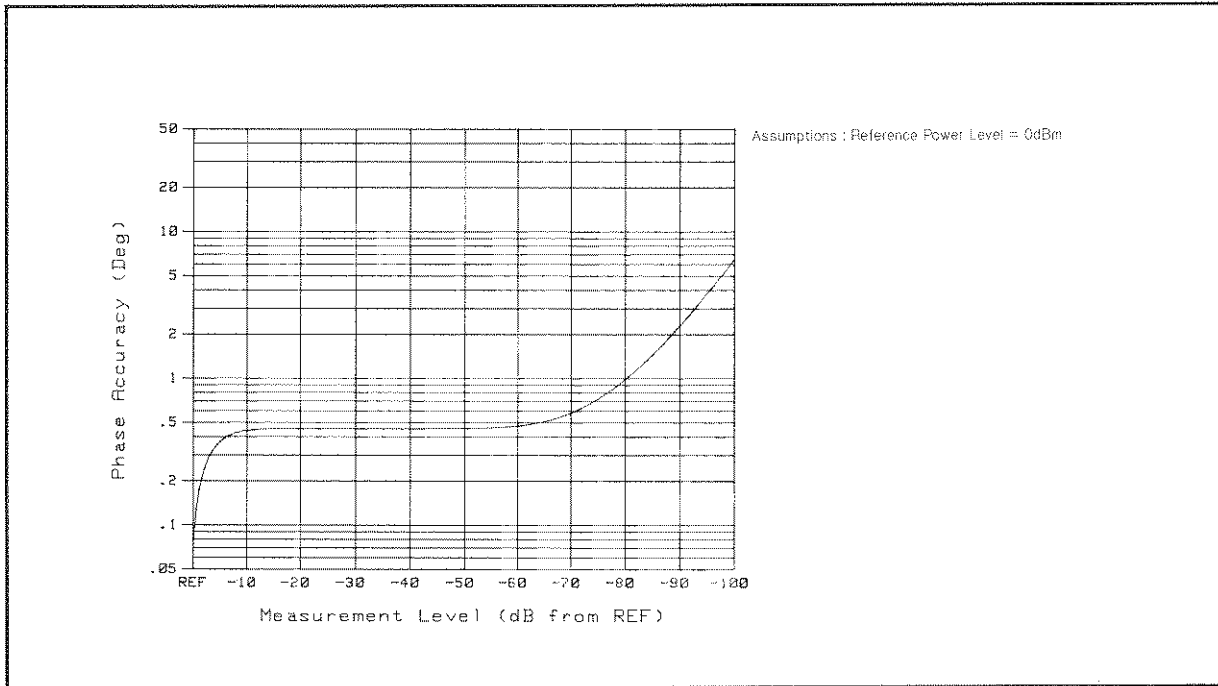

Figure 2-17. Worst-Case Phase Dynamic Accuracy Error

Dynamic Accuracy Error Contribution

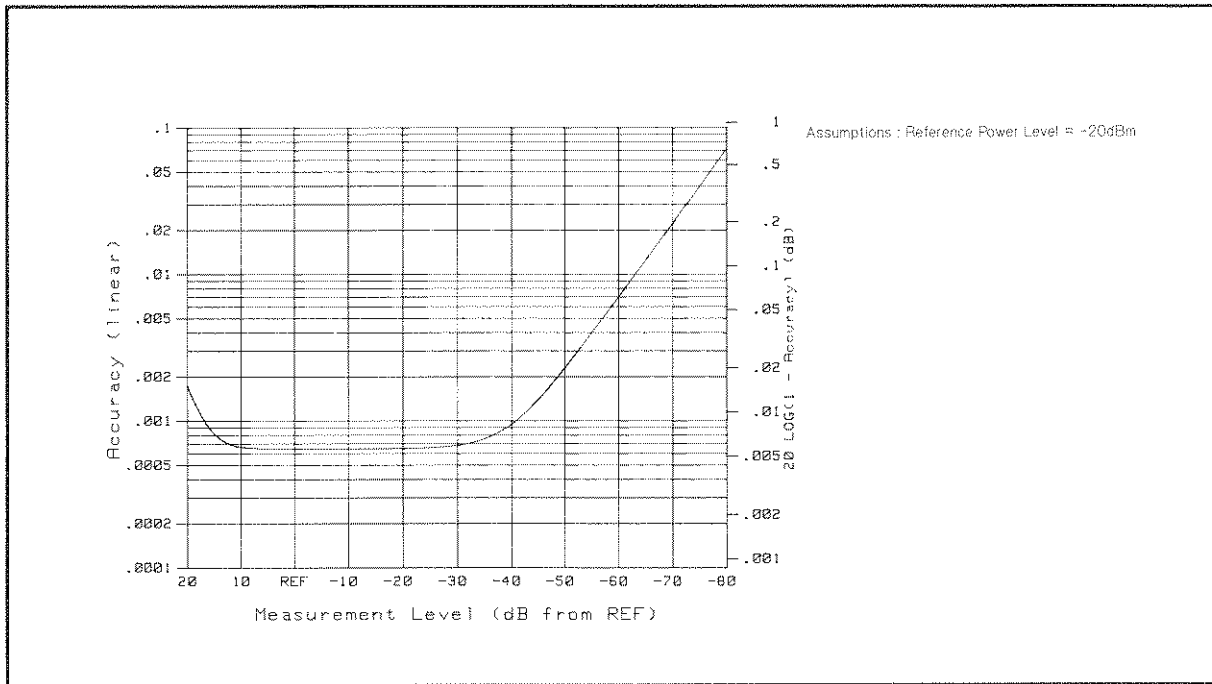

Figure 2-18. Worst-Case Magnitude Dynamic Accuracy Error

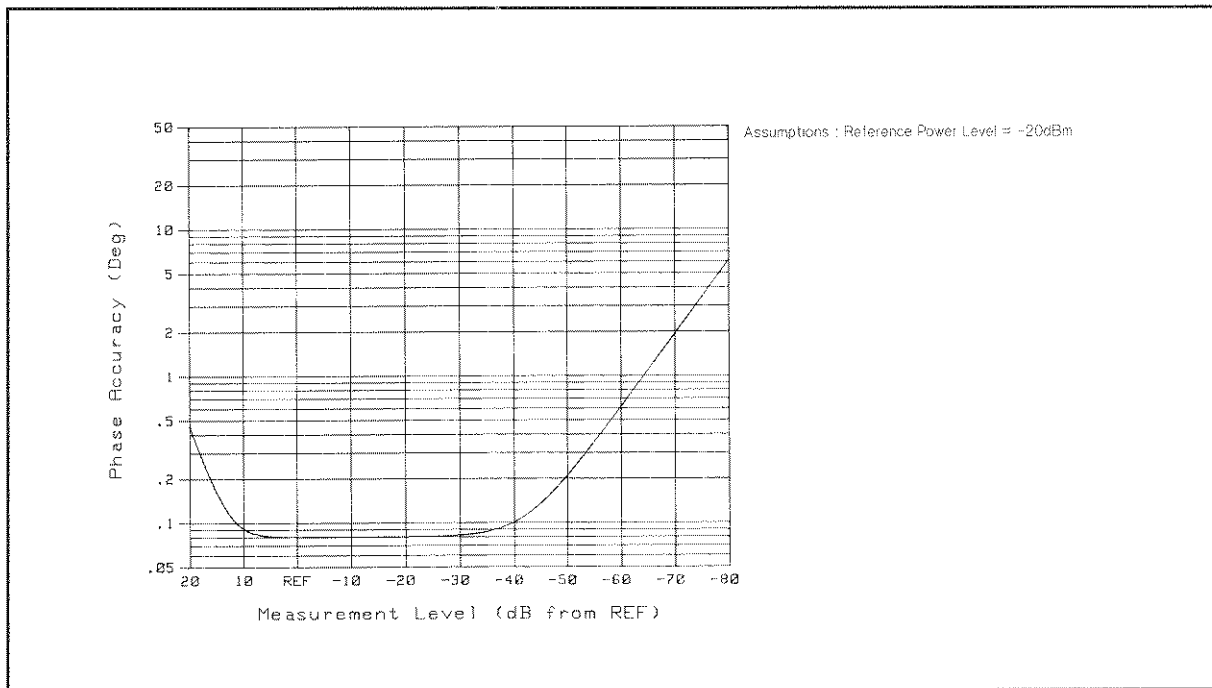

Figure 2-19. Worst-Case Phase Dynamic Accuracy Error

Dynamic Accuracy Error Contribution

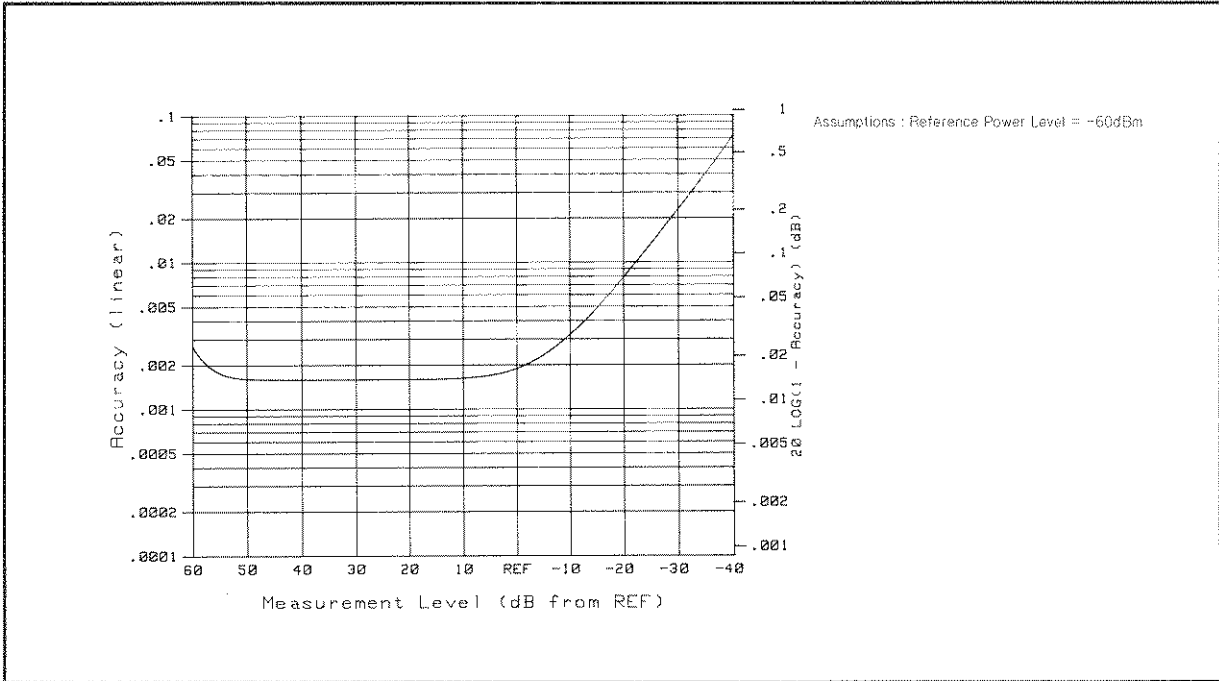

Figure 2-20. Worst-Case Magnitude Dynamic Accuracy Error

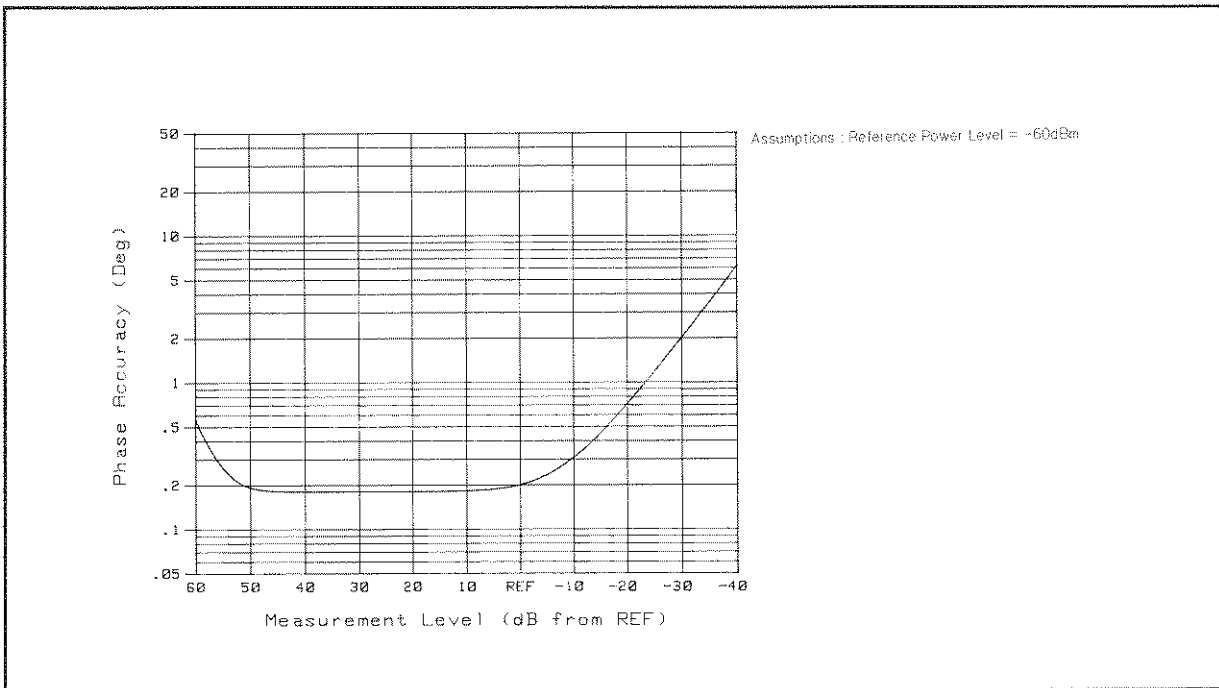

Figure 2-21. Worst-Case Phase Dynamic Accuracy Error

EFFECTS OF TEMPERATURE DRIFT

Figure 2-22 to Figure 2-25 are graphs showing the effects of temperature drift on error-corrected measurement uncertainty values. Values are shown for changes of $\pm 1^\circ\text{C}$, $\pm 3^\circ\text{C}$ and $\pm 5^\circ\text{C}$ from the ambient temperature. Figure 2-22 and Figure 2-23 show total reflection magnitude and phase uncertainty with temperature drift following an S_{11} one-port calibration. Figure 2-24 and Figure 2-25 show total transmission magnitude and phase uncertainty with temperature drift following a full two-port error correction. The graphs apply to measurements up to 500 MHz.

Temperature Drift with S_{11} One-Port Calibration

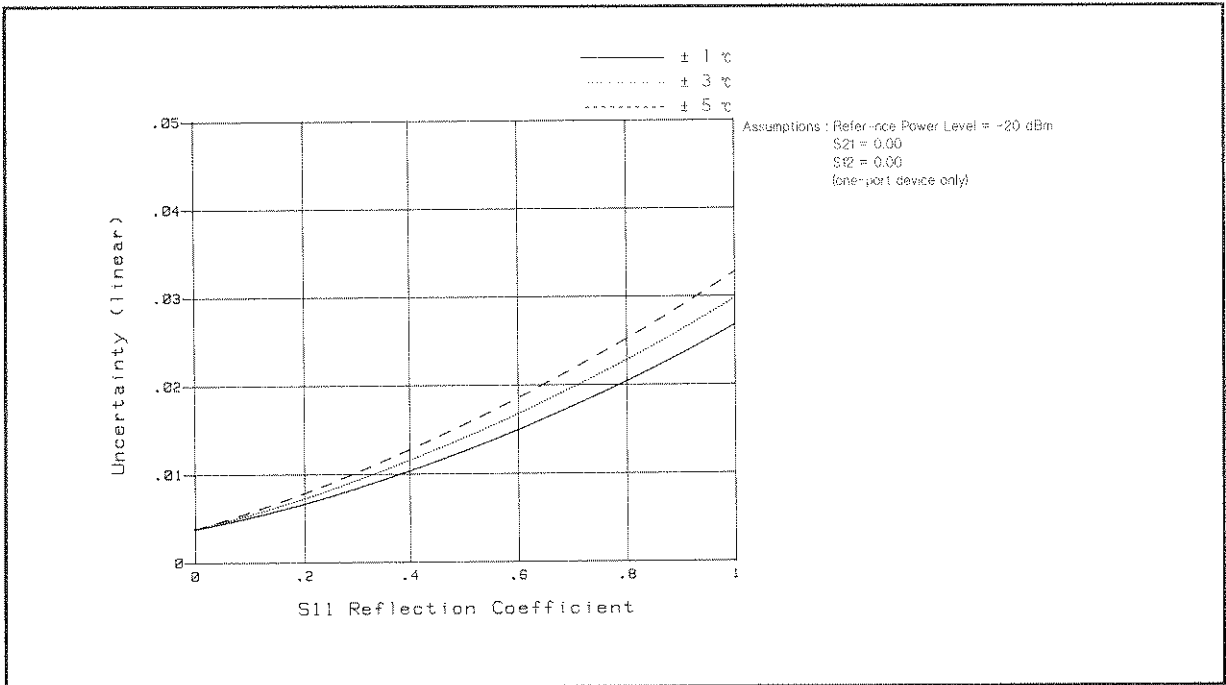

Figure 2-22. Total Reflection Magnitude Uncertainty

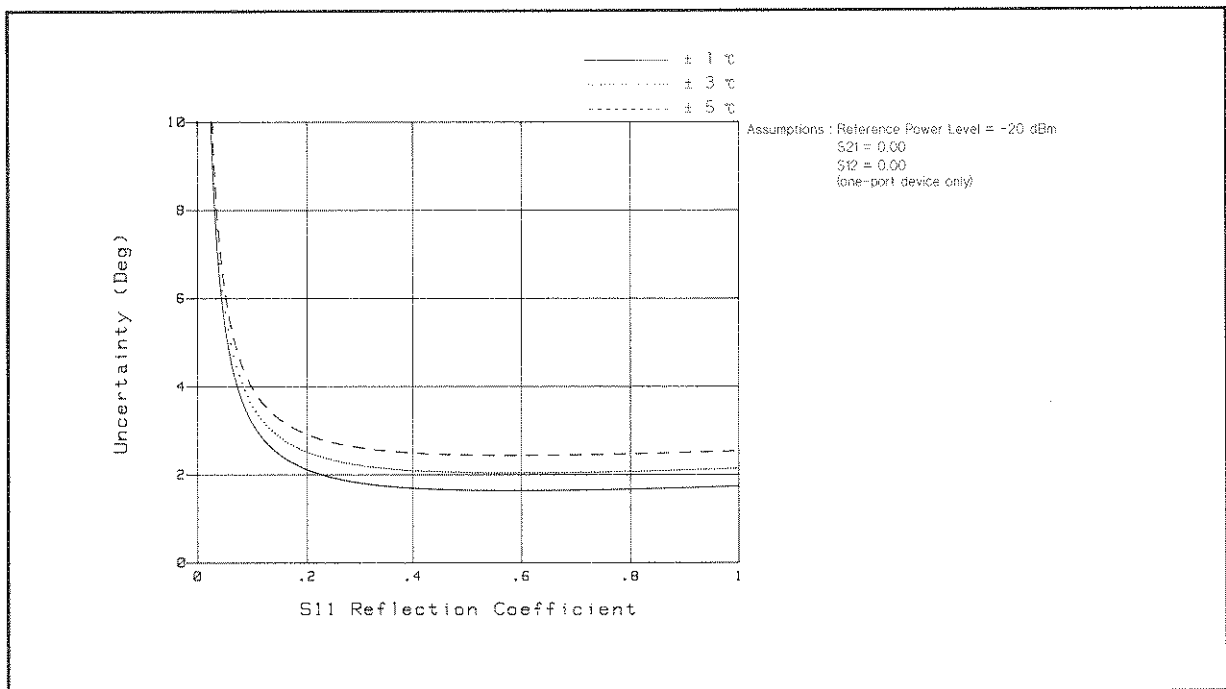

Figure 2-23. Total Reflection Phase Uncertainty

Temperature Drift with Full Two-Port Calibration

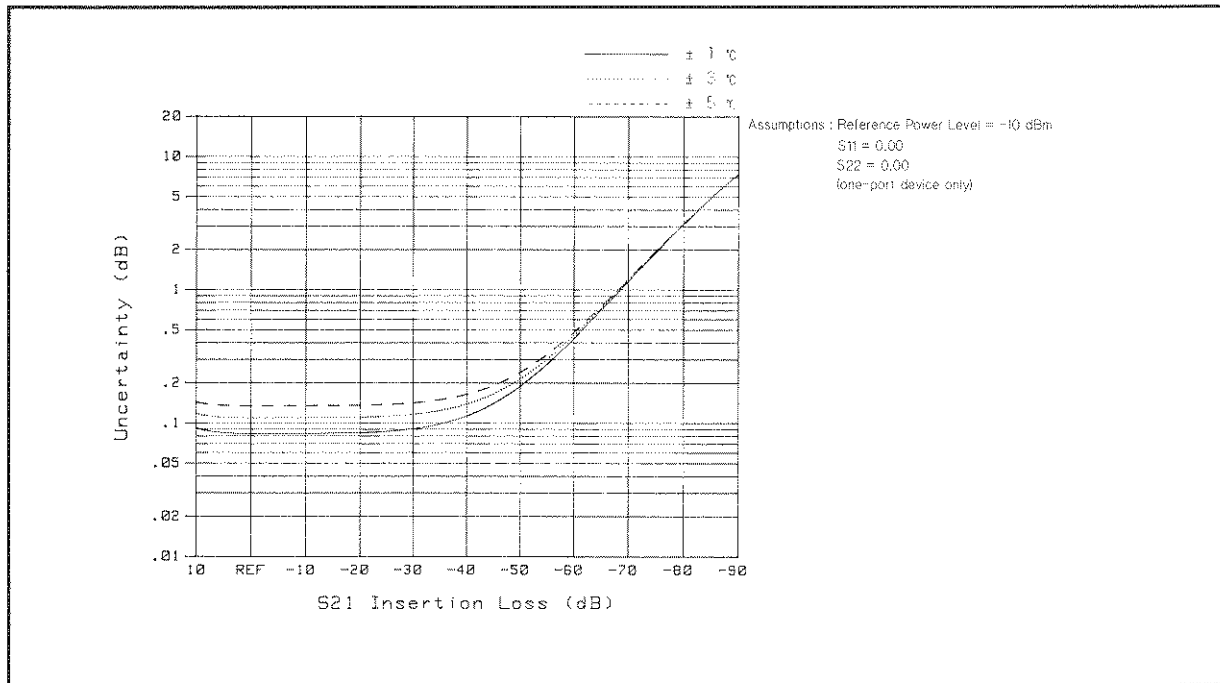

Figure 2-24. Total Transmission Magnitude Uncertainty

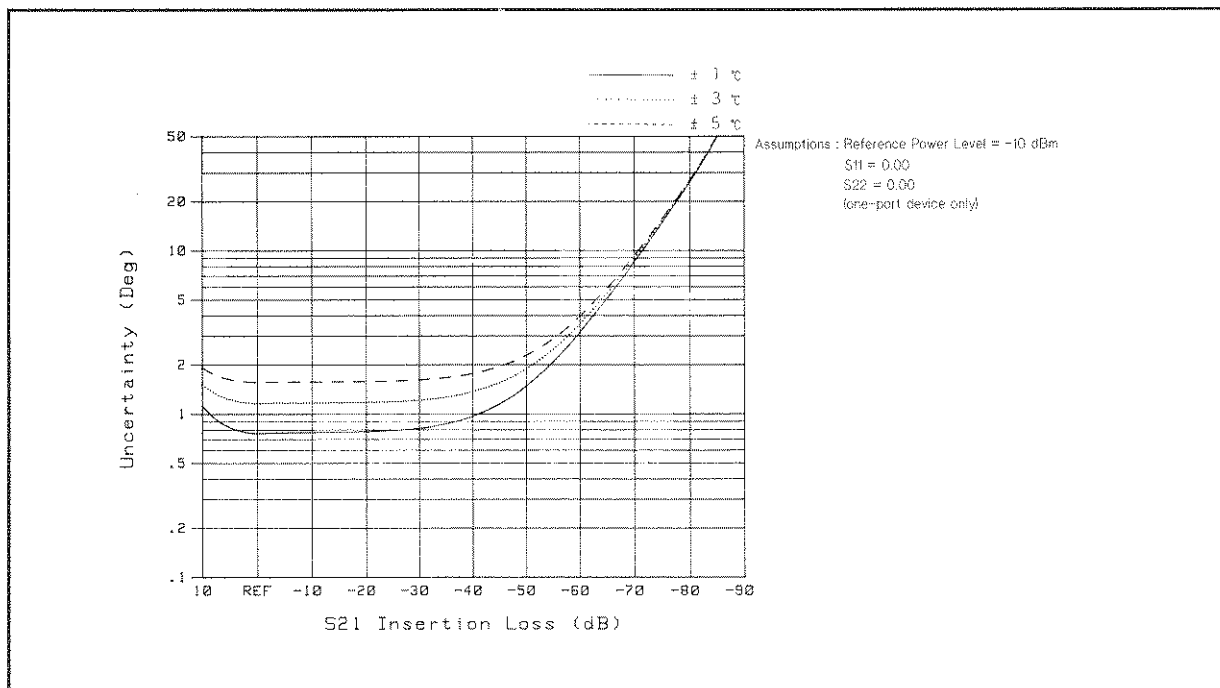

Figure 2-25. Total Transmission Phase Uncertainty

SYSTEM PERFORMANCE WITH DIFFERENT TEST SETS AND CONNECTOR TYPES

The Tables in the following pages provides typical system performance for HP 8751A systems using different test sets and different connector types. The values listed are for uncorrected measurements and for corrected measurements after measurement calibration. The linear value is shown in parenthesis under the dB value.

Table 2-3. Typical System Performance for Devices

Symbol	Error Terms	7 mm ^{1,2}		50 Ω Type N ^{2,3}		75 Ω Type N ^{2,4}	
		Uncorrected	Full two port	Uncorrected	Full two port	Uncorrected	Full two port
D	Directivity	-35 dB ⁵ (1.78×10 ⁻²)	-50 dB ⁵ (3.16×10 ⁻³)	-35 dB ⁵ (1.78×10 ⁻²)	-47 dB ⁵ (4.47×10 ⁻³)	-33 dB ⁵ (2.24×10 ⁻²)	-44 dB ⁵ (6.31×10 ⁻³)
M _s	Source Match	-20 dB (0.1)	-40 dB (0.01)	-20 dB (0.1)	-35 dB (1.78×10 ⁻²)	-20 dB (0.1)	-35 dB (1.78×10 ⁻²)
T _r	Reflection Tracking	±1.0 dB (1.22×10 ⁻¹)	±0.05 dB (5.77×10 ⁻³)	±1.0 dB (1.22×10 ⁻¹)	±0.06 dB (6.93×10 ⁻³)	±1.0 dB (1.22×10 ⁻¹)	±0.06 dB (6.93×10 ⁻³)
M _l	Load Match	-20 dB (0.1)	-42 dB (7.94×10 ⁻³)	-20 dB (0.1)	-35 dB (1.78×10 ⁻²)	-20 dB (0.1)	-35 dB (1.78×10 ⁻²)
T _t	Trans. Tracking	±1.0 dB (1.22×10 ⁻¹)	±0.03 dB (3.46×10 ⁻³)	±1.0 dB (1.22×10 ⁻¹)	±0.05 dB (5.77×10 ⁻³)	±1.0 dB (1.22×10 ⁻¹)	±0.05 dB (5.77×10 ⁻³)
C	Cross Talk	-100 dB (1.00×10 ⁻⁵)	-110 dB (3.16×10 ⁻⁶)	-100 dB (1.00×10 ⁻⁵)	-110 dB (3.16×10 ⁻⁶)	-100 dB (1.00×10 ⁻⁵)	-110 dB (3.16×10 ⁻⁶)
R _{r1}	Port1 Refl. Connector Repeatability (Typical)	-70 dB (3.16×10 ⁻⁴)		-65 dB (5.62×10 ⁻⁴)		-65 dB (5.62×10 ⁻⁴)	
R _{t1}	Port1 Trans. Connector Repeatability (Typical)	-70 dB (3.16×10 ⁻⁴)		-65 dB (5.62×10 ⁻⁴)		-65 dB (5.62×10 ⁻⁴)	
R _{r2}	Port2 Refl. Connector Repeatability (Typical)	-70 dB (3.16×10 ⁻⁴)		-65 dB (5.62×10 ⁻⁴)		-65 dB (5.62×10 ⁻⁴)	
R _{t2}	Port2 Trans. Connector Repeatability (Typical)	-70 dB (3.16×10 ⁻⁴)		-65 dB (5.62×10 ⁻⁴)		-65 dB (5.62×10 ⁻⁴)	
N _l	Low-Level Noise ⁶	-110 dBm (3.16×10 ⁻⁶)		-110 dBm (3.16×10 ⁻⁶)		-100 dBm (1.00×10 ⁻⁵)	
N _h	High Level Noise ⁶	0.001 dB (1.15×10 ⁻⁴)		0.001 dB (1.15×10 ⁻⁴)		0.001 dB (1.15×10 ⁻⁴)	
A _m , A _p	Dynamic Accuracy Error	Refer to "Dynamic Accuracy" in this section					
S _{t1}	Port 1 Cable Trans. Phase Stability	0.025 degrees ⁷		0.025 degrees ⁷		0.025 degrees ⁸	
S _{r1}	Port 1 Cable Refl. Stability	-70 dB ⁷ (3.16×10 ⁻⁴)		-70 dB ⁷ (3.16×10 ⁻⁴)		-70 dB ⁸ (3.16×10 ⁻⁴)	
S _{t2}	Port 2 Cable Trans. Phase Stability	0.025 degrees ⁷		0.025 degrees ⁷		0.025 degrees ⁸	
S _{r2}	Port 2 Cable Refl. Stability	-70 dB ⁷ (3.16×10 ⁻⁴)		-70 dB ⁷ (3.16×10 ⁻⁴)		-70 dB ⁸ (3.16×10 ⁻⁴)	
T _{td}	Trans. Tracking Drift (Typical)	Magnitude: 0.0015 /°C Phase: 0.2 degrees/°C		Magnitude: 0.0015 /°C Phase: 0.2 degrees/°C		Magnitude: 0.0015 /°C Phase: 0.2 degrees/°C	
T _{rd}	Refl. Tracking Drift (Typical)	Magnitude: 0.015 /°C Phase: 0.2 degrees/°C		Magnitude: 0.015 /°C Phase: 0.2 degrees/°C		Magnitude: 0.015 /°C Phase: 0.2 degrees/°C	
T _{sw}	Switch Tracking	±0.03 dB (3.46×10 ⁻³)					
M _{sw}	Switch Port Match	-70 dB (3.16×10 ⁻⁴)					

1 Accuracy enhancement procedures are performed using HP 85031B 7 mm calibration kit.

2 Environmental temperature is 23°C ±5°C at calibration: ±1°C from calibration temperature must be maintained for valid measurement calibration.

3 Accuracy enhancement procedures are performed using HP 85032B 50 Ω type-N calibration kit.

4 Accuracy enhancement procedures are performed using HP 85036B 75 Ω type-N calibration kit.

5 Frequency range is 300 kHz to 500 MHz.

6 With IF bandwidth of 20 Hz.

7 Arrived at by bending HP 11857D cables out perpendicular to front panel and reconnecting. Stability is better with less flexing.

8 Arrived at by bending HP 11857B cables out perpendicular to front panel and reconnecting. Stability is better with less flexing.

DETERMINING EXPECTED SYSTEM PERFORMANCE

The uncertainty equations, dynamic accuracy calculations, and tables of system performance values provided in the preceding pages can be used to calculate the expected system performance. The following pages explain how to determine the residual errors of a particular system and combine them to obtain total error-corrected residual uncertainty values, using worksheets provided. The uncertainty graphs at the beginning of this *System Performance* section are examples of the results that can be calculated using this information.

Procedures

Table 2-4 is a worksheet used to calculate the residual uncertainty in reflection measurements. Table 2-5 is a worksheet for residual uncertainty in transmission measurements. Determine the linear values of the residual error terms and the nominal linear S-parameter data of the device under test as described below and enter these values in the worksheets. Then use the instructions and equations in the worksheets to combine the residual errors for total system uncertainty performance. The resulting total measurement uncertainty values have a confidence factor of 99.9%.

S-parameter Values. Convert the S-parameters of the test device to their absolute linear terms.

Noise Floor. Refer to the *Receiver Noise Level Performance Test* in the *Maintenance Manual* to determine the actual noise floor performance of your measurement setup.

Crosstalk. Refer to the *Input Crosstalk Performance Test*. Connect an impedance-matched load to each of the test ports and measure S_{21} or S_{12} after calibration. Turn on the marker statics function (see "Using Marker" in *Reference Manual*), and measure the mean value of the trace. Use the mean value plus one standard deviation as the residual crosstalk value of your system.

Dynamic Accuracy. Determine the absolute linear magnitude dynamic accuracy as described under *Dynamic Accuracy* in the chapter.

Other Error Terms. Refer to Table 2-3, depending on the test set and connector type in your system. Find the absolute linear magnitude of the remaining error terms.

Combining Error Terms. Combine the above terms using the reflection or transmission uncertainty equation in the worksheets.

Table 2-4. Reflection Measurement Uncertainty Worksheet

In the columns below, enter the appropriate values for each term. Frequency: _____			
Error Term	Symbol	dB Value	Linear Value
Directivity	D	_____	_____
Reflection tracking	T _r	_____	_____
Source match	M _s	_____	_____
Load match	M _l	_____	_____
Dynamic accuracy (magnitude) ¹	A _m	_____	_____
Dynamic accuracy (phase) ¹	A _p	_____	_____
S ₁₁	S ₁₁	_____	_____
S ₂₁	S ₂₁	_____	_____
S ₁₂	S ₁₂	_____	_____
Noise floor ²	N _l	_____	_____
High level noise ²	N _h	_____	_____
Connector reflection repeatability	R _{r1} , R _{r2}	_____	_____
Connector transmission repeatability	R _{t1} , R _{t2}	_____	_____
Magnitude drift due to temperature	T _{rd} (mag)	_____	_____
Phase drift due to temperature	T _{rd} (phase)	_____	_____
Cable reflection stability	S _{r1} , S _{r2}	_____	_____
Cable transmission phase stability	S _{t1} , S _{t2}	_____	_____
Switch Tracking	T _{sw}	_____	_____
Switch Port Match	M _{sw}	_____	_____
Magnitude			
Combine Systematic Errors. In the space provided, enter the appropriate linear values from the list of errors. Then combine these errors to obtain the total sum of systematic errors.			
(1 + T _{sw}) × (D + S _{r1})	(_____ + _____) × (_____ + _____) = _____	(k)	
(T _{sw} + T _r) × S ₁₁	(_____ + _____) × _____ = _____	(l)	
(M _{sw} + S _{r1} + M _s) × S ₁₁ × S ₁₁	(_____ + _____ + _____) × _____ × _____ = _____	(m)	
M _l × S ₂₁ × S ₁₂	_____ × _____ × _____ = _____	(n)	
A _m × S ₁₁	_____ × _____ = _____	(o)	
Subtotal: k + l + m + n + o	_____ + _____ + _____ + _____ + _____ = _____	(S)	
Combine Random Errors. In the space provided, enter the appropriate linear values from the list of errors. Then combine these errors in an RSS fashion to obtain a total sum of the random errors.			
3 × N _l	3 × _____ = _____	(w)	
3 × N _h × S ₁₁	3 × _____ × _____ = _____	(x)	
R _{r1} + 2 × R _{t1} × S ₁₁ + R _{r1} × S ₁₁ × S ₁₁	_____ + 2 × _____ × _____ + _____ × _____ × _____ = _____	(y)	
R _{r2} × S ₂₁ × S ₁₂	_____ × _____ × _____ = _____	(z)	
$\sqrt{w^2 + x^2 + y^2 + z^2}$	$\sqrt{\text{_____}^2 + \text{_____}^2 + \text{_____}^2 + \text{_____}^2} = \text{_____}$	(R)	
Subtotal: S + R	_____ + _____ = _____	(V _r)	
Total Magnitude Errors:			
E _{rm} (linear) = V _r + T _{rd} (mag) × S ₁₁	_____ + (_____ × _____) = _____		
E _{rm} (log) = 20 Log(1 ± E _{rm} /S ₁₁)	20 Log(1 ± _____ / _____) = _____ dB		
Phase			
E _{rp} = Arcsin[(V _r - A _m × S ₁₁)/S ₁₁] + T _{rd} (phase) + 2 × S ₁₁ + A _p	Arcsin[(_____ - _____ × _____) / _____] + _____ + 2 × _____ + _____ = ± _____ degrees		

1 With IF bandwidth of 20 Hz.

2 Included in dynamic accuracy.

Table 2-5. Transmission Measurement Uncertainty Worksheet

In the columns below, enter the appropriate values for each term. Frequency: _____			
Error Term	Symbol	dB Value	Linear Value
Crosstalk	C	_____	_____
Transmission tracking	T _t	_____	_____
Source match	M _s	_____	_____
Load match	M _l	_____	_____
Dynamic accuracy (magnitude) ¹	A _m	_____	_____
Dynamic accuracy (phase) ¹	A _p	_____	_____
S ₁₁	S ₁₁	_____	_____
S ₂₁	S ₂₁	_____	_____
S ₁₂	S ₁₂	_____	_____
S ₂₂	S ₂₂	_____	_____
Noise floor ²	N _l	_____	_____
High level noise ²	N _h	_____	_____
Connector reflection repeatability	R _{r1} , R _{r2}	_____	_____
Connector transmission repeatability	R _{t1} , R _{t2}	_____	_____
Magnitude drift due to temperature	T _{td} (mag)	_____	_____
Phase drift due to temperature	T _{td} (phase)	_____	_____
Cable reflection stability	S _{r1} , S _{r2}	_____	_____
Cable transmission phase stability	S _{t1} , S _{t2}	_____	_____
Switch Tracking	T _{sw}	_____	_____
Switch Port Match	M _{sw}	_____	_____
Magnitude			
Combine Systematic Errors. In the space provided, enter the appropriate linear values from the list of errors. Then combine these errors to obtain the total sum of systematic errors.			
C			= _____ (k)
(T _{sw} + T _t) × S ₂₁	(_____ + _____) × _____		= _____ (l)
(M _{sw} + S _{r1} + M _s) × S ₁₁ × S ₂₁	(_____ + _____ + _____) × _____ × _____		= _____ (m)
(M _{sw} + S _{r2} + M _l) × S ₂₁ × S ₂₂	(_____ + _____ + _____) × _____ × _____		= _____ (n)
A _m × S ₂₁	_____ × _____		= _____ (o)
Subtotal: k + l + m + n + o	_____ + _____ + _____ + _____ + _____		= _____ (S)
Combine Random Errors. In the space provided, enter the appropriate linear values from the list of errors. Then combine these errors in an RSS fashion to obtain a total sum of the random errors.			
3 × N _l		3 × _____	= _____ (w)
3 × N _h × S ₂₁		3 × _____ × _____	= _____ (x)
R _{t1} × S ₂₁ + R _{r1} × S ₁₁ × S ₂₁	_____ × _____ + _____ × _____ × _____		= _____ (y)
R _{t2} × S ₂₁ + R _{r2} × S ₂₂ × S ₂₁	_____ × _____ + _____ × _____ × _____		= _____ (z)
$\sqrt{w^2 + x^2 + y^2 + z^2}$		$\sqrt{\text{_____} \times \text{_____} + \text{_____} \times \text{_____} + \text{_____} \times \text{_____} + \text{_____} \times \text{_____}}$	= _____ (R)
S + R		_____ + _____	= _____ (V _t)
Total Magnitude Errors:			
E _{tm} (linear) = V _t + T _{td} (mag) × S ₂₁		_____ + (_____ × _____)	= _____
E _{tm} (log) = 20 Log(1 ± E _{tm} /S ₂₁)		20 Log(1 ± _____ / _____)	= _____ dB
Phase			
E _{tp} = Arcsin[(V _t - A _m × S ₂₁)/S ₂₁] + T _{td} (phase) + S _{t1} + S _{t2} + A _p		Arcsin[(_____ - _____ × _____) / _____] + _____ + _____ + _____ + _____	= ± _____ degrees

1 With IF bandwidth of 20 Hz.
 2 Included in dynamic accuracy.

HP 8751A NETWORK ANALYZER
REFERENCE MANUAL



Printed in JAPAN October 1990

GUIDE TO THE CHAPTERS IN THIS DOCUMENT

For information on specific topics, refer to the index at the end of this volume.

This section of this document is a complete reference for operation of the HP 8751A Network Analyzer using either front panel controls, or an external controller. The information in this reference is intended to supplement the separately included tutorial documents in this volume with additional details. It is divided into chapters providing the following information:

- Chapter 1 includes a block diagram and functional description of the analyzer system. This is followed by descriptions of the front panel features and display labels, and the rear panel features and connectors.
- Chapters 2 through 11 provide detailed information on front panel keys and softkeys, their purpose and use, HP-IB equivalents in parentheses, and expected indications and results. Specific areas of operation described in these chapters include calibration procedures for accuracy enhancement, using markers, limit testing, plotting and printing, and saving instrument states.
- Chapter 12 contains information for operating the system remotely with a controller through HP-IB.
- Appendix provides a complete listing of the instrument preset state, a map of the operating softkey menu structure, information on I/O ports, and information on manual changes.
- Error Messages lists analyzer error messages, with explanations.
- Index lists an alphabetical index.

Safety Symbols

General definitions of safety symbols used on equipment or in manuals.



Instruction manual symbol: the product will be marked with this symbol when it is necessary for the user to refer to the instruction manual in order to protect against damage to the instrument.



Indicates dangerous voltage (terminals fed from the interior by voltage exceeding 1000 volts must be so marked).

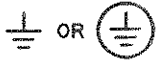

Protective conductor terminal. For protection against electrical shock in case of a fault. Used with wiring terminals to indicate the terminal which must be connected to ground before operating equipment.



Low-noise or noiseless, clean ground (earth) terminal. Used for a signal common, as well as providing protection against electrical shock in case of fault. A terminal marked with this symbol must be connected to ground before operating the equipment.

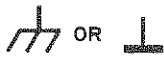

Frame or chassis terminal. A connection to the frame (chassis) of the equipment which normally includes all exposed metal structures.



Alternating current (power line).



Direct current (power line).



Alternating or direct current (power line).

Warning



Warning denotes a hazard. It calls attention to a procedure, practice, condition or the like, which, if not correctly performed or adhered to, could result in injury or death to personnel.

Caution



Caution sign denotes a hazard. It calls attention to a procedure, practice, condition or the like, which, if not correctly performed or adhered to, could result in damage to or destruction of part or all of the product.

Note



Note denotes important information. It calls attention to a procedure, practice, condition or the like, which is essential to highlight.

Contents

1. System Overview	
SYSTEM OVERVIEW	1-1
Overall Operation	1-2
The Built-In Synthesized Source	1-2
Test Sets	1-2
The Receiver Block	1-2
The Built-In Attenuators	1-2
The Microprocessors	1-2
Calibration Standards	1-3
DATA PROCESSING	1-4
Overview	1-4
Important Concepts	1-4
Processing Details	1-6
The ADCs	1-6
Digital Filter	1-6
IF Correction	1-6
Ratio Calculations	1-6
Input Attenuator Correction	1-6
Sweep-to-sweep Averaging	1-6
Raw Data Arrays	1-6
Vector Error Correction (accuracy enhancement)	1-6
Trace Math Operation	1-7
The Delay Block (Electrical Delay)	1-7
Conjugate Matching	1-7
Conversion Transforms	1-7
Unformat Data Arrays	1-7
Formatting	1-7
Smoothing	1-7
Format Arrays	1-8
Scaling	1-8
Display Memory	1-8
2. Front and Rear Panel	
INTRODUCTION	2-1
ACTIVE FUNCTION	2-1
FRONT PANEL KEYS AND SOFTKEY MENUS	2-1
Softkeys that are Joined by Vertical Lines	2-2
Softkeys That Toggle On or Off	2-2
Softkeys that Show Status Indications in Brackets	2-2
Function Key Blocks	2-2
Stimulus Block	2-2
Response Block	2-2

Instrument State Block	2-2
HP-IB Control	2-3
Information on Keys and Softkeys	2-3
FRONT PANEL FEATURES	2-4
CRT DISPLAY	2-6
REAR PANEL FEATURES AND CONNECTORS	2-9
3. Active Channel Block	
ACTIVE CHANNEL KEYS	3-1
4. Entry Block	
ENTRY BLOCK KEYS	4-1
5. Stimulus Function Block	
INTRODUCTION	5-1
MECHANICAL SWITCH HOLD	5-2
Output Power Switch	5-2
Test Port Transfer Switch	5-2
MEASURE RESTART and NUMBER of GROUPS Softkeys	5-2
START, STOP, CENTER, AND SPAN KEYS	5-3
MENU KEY	5-4
Stimulus Menu	5-5
Power Menu	5-7
Sweep Time Menu	5-8
Trigger Menu	5-10
Sweep Type Menu	5-11
List Sweep Menu	5-13
Edit List Menu	5-13
Edit Segment Menu	5-14
Edit Segment More Menu	5-16
Clear List Menu	5-17
6. Response Function Block	
INTRODUCTION	6-1
MEAS KEY	6-2
S-Parameters	6-3
DC Voltage Measurement	6-4
S-Parameter Menu	6-4
Input Ports Menu	6-6
Conversion Menu	6-7
FORMAT KEY	6-9
Format Menu	6-9
Format More Menu	6-13
GROUP DELAY PRINCIPLES	6-16
SCALE REF KEY	6-19
Scale Reference Menu	6-19
Electrical Delay Menu	6-21
DISPLAY KEY	6-23
Display Menu	6-24
Problems with Dual Channel Mode	6-24
Display More Menu	6-26

Display Allocation Menu	6-27
Trace Math Menu	6-27
Title Menu	6-29
Conjugate Matching Menu	6-30
Select Circuit Menu	6-32
Adjust Display Menu	6-33
Modify Colors Menu	6-34
Color Adjust Menu	6-35
Adjusting Color	6-35
Setting Default Colors	6-36
Saving Modified Colors	6-36
Recalling Modified Colors	6-36
AVG KEY	6-37
Averaging	6-37
Smoothing	6-38
IF Bandwidth Reduction	6-38
Group Delay Aperture	6-39
Average Menu	6-39
IF Bandwidth Menu	6-41
ATTEN KEY	6-42
Attenuator Menu	6-42

7. Measurement Calibration

INTRODUCTION	7-1
ACCURACY ENHANCEMENT	7-1
SOURCES OF MEASUREMENT ERRORS	7-2
Directivity	7-2
Source Match	7-3
Load Match	7-4
Isolation (Crosstalk)	7-5
Frequency Response (Tracking)	7-6
CORRECTING FOR MEASUREMENT ERRORS	7-6
MENUS AND SOFTKEYS	7-8
CAL Key	7-8
Standard Devices	7-9
Interpolated Error Correction	7-9
Channel Coupling	7-9
Measurement Parameters	7-10
Device Measurements	7-10
Omitting Isolation Calibration	7-10
Stopping During the Calibration Procedure	7-10
Saving Calibration Data	7-10
Specifying Calibration Kits	7-10
Correction Menu	7-11
Select Cal Kit Menu	7-12
Calibrate More Menu	7-14
Reference Plane Menu	7-15
DC Correction Menu	7-16
Calibration Menu	7-17
Response Calibration for Reflection Measurements	7-20
Response Calibration for Transmission Measurements	7-21

Response and Isolation Calibration for Reflection Measurements	7-22
Response and Isolation Calibration for Transmission Measurements	7-24
S ₁₁ 1-Port Calibration for Reflection Measurements	7-25
S ₂₂ 1-Port Calibration	7-26
Full 2-Port Calibration for Reflection and Transmission Measurements	7-27
One-Path 2-Port Calibration for Reflection and Transmission Measurements	7-31
MODIFYING CALIBRATION KITS	7-34
Definitions	7-35
Procedure	7-35
Modify Cal Kit Menu	7-35
Define Standard Number Menu	7-37
Define Standard Menus	7-37
Specify Offset Menu	7-41
Label Standard Menu	7-42
Specify Class Menus	7-42
Label Class Menus	7-45
Label Kit Menu	7-45
Verify Performance	7-46
Example Procedure for Specifying a User-Defined Calibration Kit	7-46
APPENDIX TO CHAPTER 7	7-47
Accuracy Enhancement Fundamentals-Characterizing Systematic Errors	7-47
One-Port Error Model	7-47
Measuring reflection coefficient	7-48
Directivity error	7-48
Source match error	7-48
Frequency response error	7-49
How calibration standards are used to quantify these error terms	7-49
Two-Port Error Model	7-52
Measuring Transmission Coefficient	7-52
Load Match Error	7-53
Isolation Errors	7-53
Error Terms the Analyzer Can Reduce	7-54
8. Using Markers	
(MKR) KEY	8-1
MARKER MENU	8-4
Activate marker menu	8-5
Clear Marker Menu	8-6
Delta Marker Mode Menu	8-7
Delta Marker Menu	8-8
Fixed Marker Menu	8-9
Marker Mode Menu	8-10
Polar Marker Menu	8-11
Smith Marker Menu	8-12
(MKR FCTN) KEY	8-14
Marker Function Menu	8-15
Search Range Menu	8-16
Marker Search Menu	8-17
Target Menu	8-18
Marker Search More Menu	8-19
Note For Peak Define	8-20

Width Menu	8-21
9. Instrument State Function Block	
INTRODUCTION	9-1
INSTRUMENT STATE FUNCTIONS AND WHERE THEY ARE DESCRIBED	9-2
LOCAL Key	9-3
Local Lockout	9-3
HP-IB Menu	9-3
System Controller Mode	9-4
Addressable Mode	9-4
Address Menu	9-5
SYSTEM KEY	9-7
System Menu	9-7
Clock Menu	9-8
Set Time Menu	9-9
Set Date Menu	9-10
LIMIT LINE AND LIMIT TESTING	9-11
How Limit Lines are Entered	9-13
Turning Limit Lines Limit Testing On and Off	9-14
Segments Entering Order Needs Notice	9-14
Saving the Limit Line Table	9-14
Offsetting the Stimulus or Amplitude of the Limit Lines	9-14
Supported Display Formats	9-14
Use a Sufficient Number of Points or Errors May Occur	9-15
Displaying, Printing, or Plotting Limit Test Data	9-15
Results of Plotting or Printing the Display with Limit Lines ON	9-15
Limits Menu	9-16
Edit Limits Menu	9-17
Edit Segment Menu	9-18
Clear List Menu	9-20
Offset Limit Menu	9-21
INSTRUMENT BASIC (OPTION 002)	9-21
10. Making Hard Copies	
INTRODUCTION	10-1
About Making Hard Copies, Where Compatible Printers and Plotters are Mentioned	10-1
Where to Find Tutorial Information	10-1
Printing/Plotting with or without a Controller on the Bus	10-1
PRINT/PLOT BUFFER	10-1
COPY KEY	10-2
Copy Menu	10-4
Print/Plot Setup Menu	10-5
Select Quadrant Menu	10-7
Define Plot Menu	10-8
Pen Numbers	10-8
Scale Plot Menu	10-9
Copy More Menu	10-11
Copy Cal Kit Menu	10-13
Copy Standard Number Menu	10-14

Copy List Sweep Menu	10-14
Copy Limit Test Menu	10-15
Screen Menu	10-16
11. Saving and Recalling Instrument States and Data	
INTRODUCTION	11-1
THREE DATA GROUPS	11-1
Instrument State	11-1
Internal Data Arrays	11-1
Instrument States and Internal Data Arrays	11-2
ADDITIONAL INFORMATION	11-2
File Names	11-2
Disk Requirements	11-3
Disk Format	11-3
Auto Recall Function	11-3
File Size	11-3
File Structure of Internal Data Arrays File	11-4
File Header	11-4
Data Group	11-4
Data Segment	11-6
(SAVE) AND (RECALL) KEYS	11-6
Save Menu	11-8
Save File Menu	11-9
Title Menu	11-10
Define Save Data Menu	11-11
Re-save File Menu	11-12
Disk Menu	11-13
Purge File Menu	11-14
Purge Menu	11-15
Initialize Menu	11-16
Recall Menu	11-17
Recall File Menu	11-18
12. HP-IB Remote Programming	
INTRODUCTION	12-1
HOW HP-IB WORKS	12-2
Talker	12-2
Listener	12-2
Controller	12-2
HP-IB REQUIREMENTS	12-2
ANALYZER HP-IB CAPABILITIES	12-3
BUS MODE	12-3
SETTING ADDRESSES	12-4

A. Default		
PRESET STATE		A-1
PREDEFINED CALIBRATION KIT		A-6
Predefined Standards		A-6
Predefined Standard Class Assignments		A-8
B. Menu Map		
INTRODUCTION		B-1
C. I/O Port		
I/O PORT		C-1
Pin Assignment		C-1
Related HP-IB Commands		C-2
Using The I/O Port Without an External Controller nor Instrument BASIC		C-2
D. Manual Changes		
INTRODUCTION		D-1
MANUAL CHANGES		D-1
Messages		
ERROR MESSAGES IN ALPHABETICAL ORDER		Messages-1
ERROR MESSAGES IN NUMERICAL ORDER		Messages-14
Index		

Figures

1-1. Simplified Block Diagram of the Network Analyzer System	1-1
1-2. Data Processing Flow Diagram	1-5
2-1. HP 8751C Front Panel	2-4
2-2. CRT Display (Single Channel, Cartesian Format)	2-6
2-3. HP 8751A Rear Panel	2-9
3-1. Active Channel Keys	3-1
4-1. Entry Block	4-1
5-1. Stimulus Function Block	5-1
5-2. Softkey Menus Accessed from the MENU Key	5-4
5-3. Stimulus Menu	5-5
5-4. Power Menu	5-7
5-5. Sweep Time Menu	5-8
5-6. Trigger Menu	5-10
5-7. Sweep Type Menu	5-11
5-8. List Sweep Menu	5-13
5-9. Edit List Menu	5-14
5-10. Edit Segment Menu	5-15
5-11. Edit Segment More Menu	5-16
5-12. Clear List Menu	5-17
6-1. Response Function Block	6-1
6-2. Softkey Menus Accessed from the MEAS Key	6-2
6-3. S-Parameters of a Two-Port Device	6-3
6-4. S-Parameter Menu	6-5
6-5. Input Ports Menu	6-6
6-6. Reflection Impedance and Admittance Conversions	6-7
6-7. Transmission Impedance and Admittance Conversions	6-7
6-8. Conversion Menu	6-8
6-9. Format and Format More Menus	6-9
6-10. Log Magnitude Format	6-10
6-11. Phase Format	6-10
6-12. Group Delay Format	6-11
6-13. Smith Chart Format	6-11
6-14. Polar Format	6-12
6-15. Linear Magnitude Format	6-12
6-16. Typical SWR Display	6-13
6-17. Real Format	6-13
6-18. Expanded phase Format	6-14
6-19. Inverse Smith Chart Formats	6-14
6-20. Log Magnitude and Phase Format	6-15
6-21. Log magnitude and Delay Format	6-15
6-22. Constant Group Delay	6-16
6-23. Higher Order Phase Shift	6-16

6-24. Rate of Phase Change Versus Frequency	6-17
6-25. Variations in Frequency Aperture	6-17
6-26. Softkey Menus Accessed from the SCALE REF Key	6-19
6-27. Scale Reference Menu	6-19
6-28. Electrical Delay Menu	6-21
6-29. Softkey Menus Accessed from the DISPLAY Key	6-23
6-30. Display Menu	6-24
6-31. Full-screen and Split Display	6-25
6-32. Display More Menu	6-26
6-33. Display Allocation Menu	6-27
6-34. Trace Math Menu	6-28
6-35. Title Menu	6-29
6-36. Conjugate Matching Menu	6-30
6-37. Matching Circuits	6-31
6-38. Select Circuit Menu	6-32
6-39. Adjust Display Menu	6-33
6-40. Modify Colors Menu	6-34
6-41. Color Adjust Menu	6-35
6-42. Softkey Menus Accessed from the AVG Key	6-37
6-43. Effect of Averaging on a Trace	6-37
6-44. Effect of Smoothing on a Trace	6-38
6-45. IF Bandwidth Reduction	6-39
6-46. Average Menu	6-39
6-47. IF Bandwidth Menu	6-41
6-48. Attenuator Menu	6-42
7-1. Directivity	7-3
7-2. Source Match	7-4
7-3. Load Match	7-5
7-4. Response vs. S_{11} 1-Port Calibration on Log Magnitude Format	7-7
7-5. Response vs. Full Two-Port Calibration	7-7
7-6. Softkey Menus Accessed from the CAL Key	7-8
7-7. Correction Menu	7-11
7-8. Select Cal Kit Menu	7-13
7-9. Calibrate More Menu	7-14
7-10. Reference Plane Menu	7-15
7-11. DC Correction Menu	7-16
7-12. Calibration Menu	7-18
7-13. Response Cal Menu	7-20
7-14. Response and Isolation Cal Menu and Response Cal Menu	7-22
7-15. S_{11} and S_{22} 1-Port Cal Menus	7-25
7-16. Full 2-Port Cal Menu	7-28
7-17. One-Path 2-Port Cal Menu	7-32
7-18. Modify Cal Kit Menu	7-36
7-19. Define Standard Number Menu	7-37
7-20. Define Standard Menus	7-39
7-21. Specify Offset Menu	7-41
7-22. Label Standard Menu	7-42
7-23. Specify Class Menus	7-44
7-24. Label Class Menus	7-45
7-25. Sources of Error in a Reflection Measurement	7-47
7-26. Reflection Coefficient	7-48

7-27. Effective Directivity E_{DF}	7-48
7-28. Source Match E_{SF}	7-49
7-29. Reflection Tracking E_{RF}	7-49
7-30. "Perfect Load" Termination	7-50
7-31. Measured Effective Directivity	7-50
7-32. Short Circuit Termination	7-51
7-33. Open Circuit Termination	7-51
7-34. Measured S_{11}	7-51
7-35. Major Sources of Error	7-52
7-36. Transmission Coefficient	7-52
7-37. Load Match E_{LF}	7-53
7-38. Isolation E_{XF}	7-54
7-39. Full Two-Port Error Model	7-55
8-1. Markers on Trace	8-1
8-2. Menus Accessed from the MKR Key	8-3
8-3. Marker Menu	8-4
8-4. Activate Marker Menu	8-5
8-5. Clear Marker Menu	8-6
8-6. Delta Marker Mode Menu	8-7
8-7. Delta Marker Menu	8-8
8-8. Fixed Marker Menu	8-9
8-9. Marker Mode Menu	8-10
8-10. Polar Marker Menu	8-11
8-11. Smith Marker Menu	8-12
8-12. Menus Accessed from the MKR FCTN Key	8-14
8-13. Marker Function Menu	8-15
8-14. Search Range Menu	8-16
8-15. Marker Search Menu	8-17
8-16. Target Menu	8-18
8-17. Marker Search More Menu	8-19
8-18. Peak Definition Example	8-20
8-19. Width Menu	8-21
8-20. Bandwidth Search Example	8-22
9-1. Instrument State Function Block	9-1
9-2. Softkey Menus Accessed from the LOCAL Key	9-3
9-3. HP-IB Menu	9-4
9-4. Address Menu	9-6
9-5. System Menu	9-7
9-6. Softkey Menus Accessed from the SET CLOCK Softkey	9-8
9-7. Clock Menu	9-8
9-8. Set Time Menu	9-9
9-9. Set Date Menu	9-10
9-10. Softkey Menus Access from the LIMIT MENU softkey.	9-12
9-11. The Concept of Segments as a Point between Two Sets of Limit Lines	9-13
9-12. Limits Menu	9-16
9-13. Edit Limits Menu	9-18
9-14. Edit Segment Menu	9-19
9-15. Clear List Menu	9-20
9-16. Offset Limit Menu	9-21
10-1. Softkey Menus Accessed from the COPY Key	10-3

10-2. Copy Menu	10-4
10-3. Print/Plot Setups Menu	10-5
10-4. Select Quadrant Menu	10-7
10-5. Define Plot Menu	10-8
10-6. Scale Plot Menu	10-9
10-7. Full, Upper and Lower Graticule	10-10
10-8. Copy More Menu	10-11
10-9. Copy Cal Kit Menu	10-13
10-10. Copy Standard Number Menu	10-14
10-11. Copy List Sweep Menu	10-14
10-12. Copy Limit Test Menu	10-15
10-13. Screen Menu	10-16
11-1. File Header Structure	11-4
11-2. RAW Data Group Structure	11-5
11-3. CAL Data Group Structure	11-5
11-4. Data Segment	11-6
11-5. Softkey Menus Accessed from the SAVE and RECALL Keys	11-7
11-6. Save Menu	11-8
11-7. Save File Menu	11-9
11-8. Title Menu	11-10
11-9. Define Save Data Menu	11-11
11-10. Re-save File Menu	11-12
11-11. Disk Menu	11-13
11-12. Purge File Menu	11-14
11-13. Purge Menu	11-15
11-14. Initialize Menu	11-16
11-15. Recall Menu	11-17
11-16. Recall File Menu	11-18
12-1. Analyzer Single Bus Concept	12-4
B-1. Operating Softkey Menu Map (1 of 5)	B-1
B-2. Operating Softkey Menu Map (2 of 5)	B-2
B-3. Operating Softkey Menu Map (3 of 5)	B-3
B-4. Operating Softkey Menu Map (4 of 5)	B-4
B-5. Operating Softkey Menu Map (4 of 5)	B-5
C-1. I/O Port Pin Assignments	C-1
C-2. An Example of a Test System Without Controller	C-2

Tables

5-1. Minimum Sweep Time In Seconds (Typical Value)	5-9
6-1. IF Bandwidth in AUTO mode	6-41
7-1. Differences between PORT EXTENSIONS and ELECTRICAL DELAY	7-14
7-2. Purpose and Use of Different Calibration Procedures	7-19
7-3. Standard Definitions	7-38
7-4. Standard Class Assignments Table	7-43
9-1. Instrument State Function Descriptions	9-2
9-2. Default HP-IB Addresses	9-5
10-1. Default Plotting Parameters	10-6
10-2. Pen Numbers	10-8
10-3. List Value Format	10-12
11-1. File Size Versus Number of Points	11-3
A-1. Preset Conditions	A-1
A-2. Preset conditions	A-2
A-3. Preset conditions	A-3
A-4. Preset conditions	A-4
A-5. Preset conditions	A-5
A-6. Results of Power Loss to Battery Backup Memory (Factory Setting)	A-6
A-7. 7 mm Standard Cal Kit	A-6
A-8. 50 Ω Type-N Standard Cal Kit	A-7
A-9. 75 Ω Type-N Standard Cal Kit	A-7
A-10. Standard Class Assignments Table (7 mm)	A-8
D-1. Manual Changes by Serial Number	D-1
D-2. Manual Changes by Firmware's Version	D-1

Contents

1. System Overview	
SYSTEM OVERVIEW	1-1
Overall Operation	1-2
The Built-In Synthesized Source	1-2
Test Sets	1-2
The Receiver Block	1-2
The Built-In Attenuators	1-2
The Microprocessors	1-2
Calibration Standards	1-3
DATA PROCESSING	1-4
Overview	1-4
Important Concepts	1-4
Processing Details	1-6
The ADCs	1-6
Digital Filter	1-6
IF Correction	1-6
Ratio Calculations	1-6
Input Attenuator Correction	1-6
Sweep-to-sweep Averaging	1-6
Raw Data Arrays	1-6
Vector Error Correction (accuracy enhancement)	1-6
Trace Math Operation	1-7
The Delay Block (Electrical Delay)	1-7
Conjugate Matching	1-7
Conversion Transforms	1-7
Unformat Data Arrays	1-7
Formatting	1-7
Smoothing	1-7
Format Arrays	1-8
Scaling	1-8
Display Memory	1-8

Figures

1-1. Simplified Block Diagram of the Network Analyzer System	1-1
1-2. Data Processing Flow Diagram	1-5

System Overview

SYSTEM OVERVIEW

Network analyzers measure the reflection and transmission characteristics of devices and networks by applying a known swept signal and measuring the response of the test device. The signal transmitted through the device or reflected from its input is compared with the incident signal generated by a swept RF source. The signals are applied to a receiver for measurement, signal processing, and display. A network analyzer system consists of a source, signal separation devices, a receiver, and a display.

The HP 8751A vector network analyzer integrates a high resolution synthesized RF source and a dual channel three-input receiver to measure and display magnitude, phase, and group delay of transmitted and reflected power. The HP 8751A Option 002 has the additional capability of programming the measurement sequence and controlling other HP-IB instrument without an external controller. Other options are explained in the General Information and Specifications sections. Figure 1-1 is a simplified block diagram of the network analyzer system. A detailed block diagram of the analyzer is provided in the *Service Manual* (HP Part Number:08751-90031), together with complete theory of system operation.

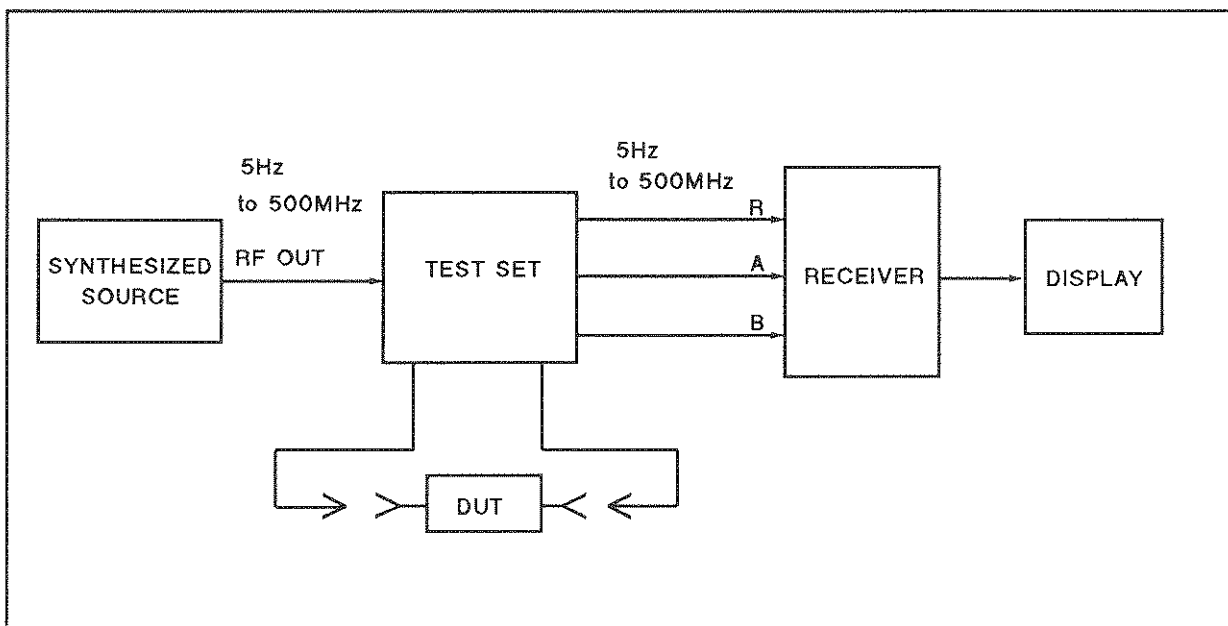

Figure 1-1. Simplified Block Diagram of the Network Analyzer System

Overall Operation

The source RF signal is transmitted through the device under test (DUT) and is then applied to the B input of the receiver. The portion of the signal that reflects off the DUT's input port is coupled to the receiver's A input. The A and B inputs are compared to the original signal at the R input to characterize reflection and transmission response of the DUT.

The Built-In Synthesized Source

The analyzer's built-in synthesized source produces a swept RF signal in the range of 5 Hz to 500 MHz. The RF output power is leveled by an internal ALC (automatic leveling control) circuit. To achieve frequency accuracy and phase measuring capability, the analyzer is phase locked to a highly stable crystal oscillator.

Test Sets

A test set provides connections to the device under test, as well as the signal separation devices that separate the incident signal from the transmitted and reflected signals. The incident signal is applied to the R (reference) input, and the reflected and transmitted signals are applied to the A or B inputs.

The HP 87511A/B S-parameter test sets contain the hardware required to make simultaneous transmission and reflection measurements in both the forward and reverse directions. An RF path switch in the test set is controlled by the network analyzer so that reverse measurements can be made without changing the connections to the device under test. The HP 87512A/B Transmission/Reflection Test Kits contain the hardware required to make simultaneous transmission and reflection measurements in one direction only. The HP 11850C/D three-way power splitters or the HP 11667A two-way power splitter can be used for making transmission-only measurements.

The Receiver Block

The receiver block contains identical mixers for the R, A, and B inputs. The signals are mixed to produce a 5 kHz IF (intermediate frequency) to be converted to digital data. Both amplitude and phase information are measured simultaneously, regardless of what is displayed on the CRT.

The Built-In Attenuators

The built-in attenuators in the HP 8751A adjust the power level to the reference port and test ports of the HP 8751A without changing the level of the incident power to the DUT. The built-in attenuators are controlled from the front panel of the analyzer.

The Microprocessors

The microprocessors take the raw data and perform all the required error correction, trace math, formatting, scaling, and marker operations, according to the instructions from the front panel. The formatted data is then displayed on the CRT. The data processing sequence is described below.

Calibration Standards

In addition to the analyzer and the test set (or power splitter), a measurement may require calibration standards for vector accuracy enhancement, and cables for interconnections. Model numbers and details of compatible power splitters, calibration kits, and cables are provided in the General Information and Specifications.

DATA PROCESSING

Overview

The analyzer's receiver converts the R, A, and B input signals into useful measurement information. This conversion occurs in two main steps. First, the swept high frequency input signals are translated to fixed low frequency IF signals, using analog mixing techniques. Refer to "Theory of Operation" in the *Service Manual* for details. Second, the IF signals are converted into digital data by an analog-to-digital converter (ADC). From this point on, all further signal processing is performed mathematically by the analyzer microprocessors. The following paragraphs describe the sequence of math operations and the resulting data arrays as the information flows from the ADC to the display. They provide a good foundation for understanding most of the response functions, and the order in which they are performed.

Figure 1-2 is a data processing flow diagram that represents the flow of numerical data from IF detection to display. The data passes through several math operations, denoted in the figure by single-line boxes. Most of these operations can be selected and controlled with the front panel RESPONSE block menus. The data is also stored in data arrays along the way, denoted by double-line boxes. These arrays are places in the flow path where data is accessible via HP-IB or using the internal disk drive.

Important Concepts

- **Stimulus** is whatever is being measured on the display x-axis (frequency, or power).
- A **data point** or **point** is a single piece of data representing a measurement at a single stimulus value. Most data processing operations are performed point-by-point; some involve more than one point.
- A **sweep** is a series of consecutive data point measurements, taken over a sequence of stimulus values. A few data processing operations require that a full sweep of data is available. The number of points per sweep is user defined, while the default number of points is 201. Note that the meaning of the stimulus values (independent variables) can change, depending on the *sweep type*, although this does not generally affect the data processing path. Examples of sweep types are linear frequency, logarithmic frequency, power sweep. Frequency list mode is the last sweep type, it allows you to choose specific stimulus points to be measured.

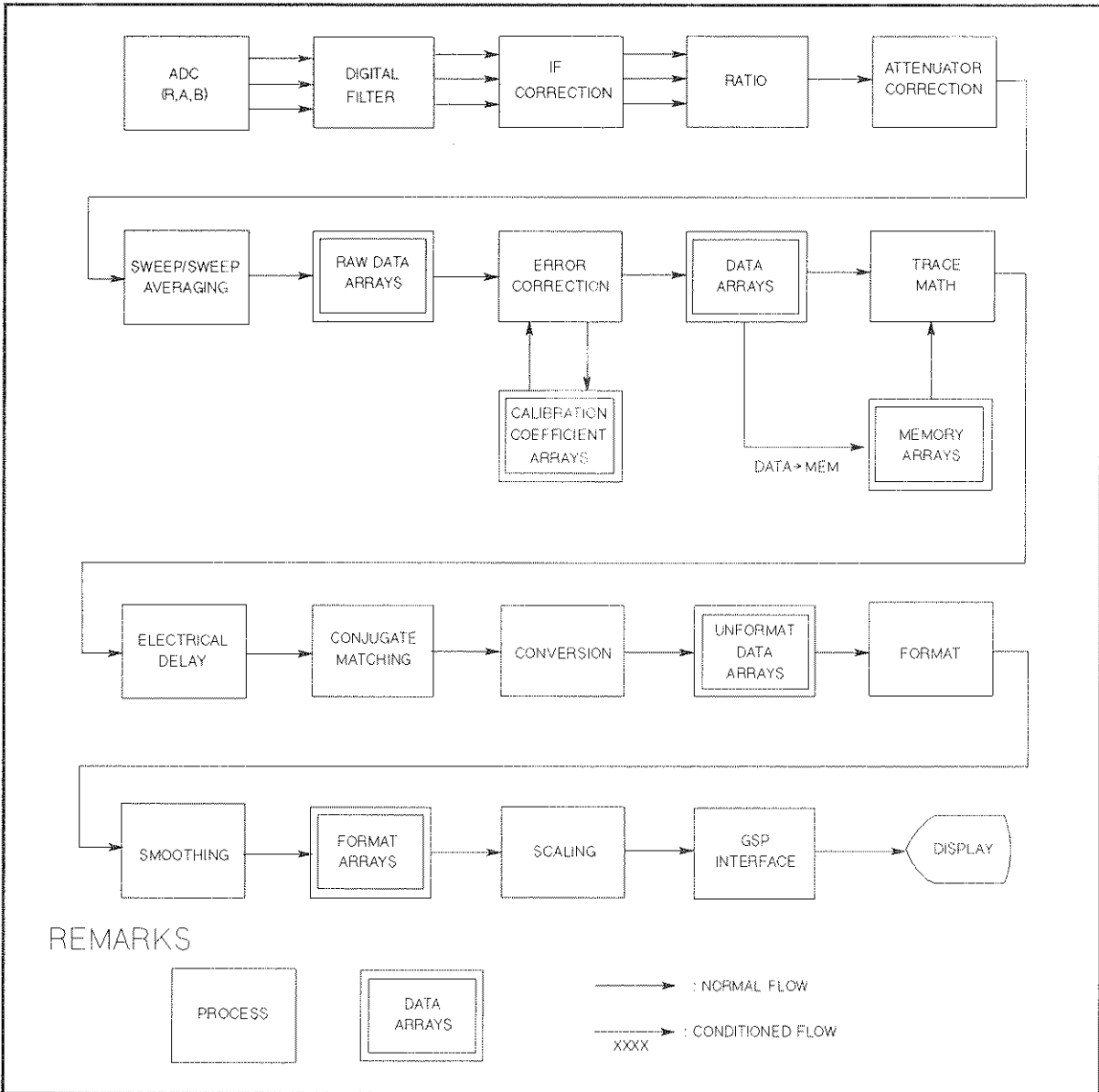

C2001002

Figure 1-2. Data Processing Flow Diagram

Note



While only a single flow path is shown, two identical paths are available, corresponding to channel 1 and channel 2. When the channels are uncoupled, each channel can be independently controlled, so that the data processing operations for one are different from the other.

Processing Details

The ADCs

The ADCs at every port (R, A, and B) convert an analog signal, which is already down-converted to a fixed low frequency IF, into digital data. Refer to “**MEAS** KEY” in Chapter 6 for more information on inputs.

Digital Filter

The digital filter detects the IF signal by performing a discrete Fourier transform (DFT) on the digital data. The samples are converted into complex number pairs, real plus imaginary, $R+jI$, which represent both the magnitude and phase of the IF signal. If the Bdc input is selected, the imaginary part of the pair is set to zero. The filter shape can be altered by selecting the IF bandwidth from among 2, 20, 200, 1 k, and 4 kHz, which is a highly effective technique for noise reduction. Refer to “**AVG** KEY” in Chapter 6 for information on different noise reduction techniques.

IF Correction

This process digitally corrects for frequency response errors in the analog down conversion path.

Ratio Calculations

These are performed if the selected measurement is a ratio of two inputs (e.g. A/R or B/R). This is simply a complex divide operation. If the selected measurement is absolute (e.g. A or B), no operation is performed. The R, A, and B values are also split into channel data at this point. Refer to “**MEAS** KEY” in Chapter 6 for more information.

Input Attenuator Correction

If the built-in attenuator is used, this corrects the value to be equal to what it was before being attenuated.

Sweep-to-sweep Averaging

This is one of the noise reduction techniques. This calculation involves taking the complex exponential average of up to 999 consecutive sweeps. Refer to “**AVG** KEY” in Chapter 6.

Raw Data Arrays

These store the results of all the preceding data processing operations. When full 2-port error correction is on, the raw data arrays contain all four S-parameter measurements required for accuracy enhancement. When the channels are uncoupled (coupled channels off), there may be as many as eight raw data arrays. These arrays are directly accessible via HP-IB, or using the internal disk drive. Note that the numbers here are still complex pairs.

Vector Error Correction (accuracy enhancement)

When a measurement calibration has been performed and correction is turned on, error correction removes repeatable systematic errors, stored in the calibration coefficient arrays, from the raw data arrays. This can vary from simple vector normalization to full 12-term error correction. Refer to Chapter 7 for details.

The calibration coefficient arrays themselves are created during a measurement calibration using data from the raw data arrays. These are subsequently used whenever correction is on, and are accessible via HP-IB, or using the internal disk drive.

The results of error correction are stored in the data arrays as complex number pairs. These arrays are accessible via HP-IB, or using the internal disk drive.

If the data-to-memory operation is performed, the data arrays are copied into the memory arrays. Refer to “**DISPLAY** KEY” in Chapter 6.

Trace Math Operation

This selects either the data array, memory array, or both to continue flowing through the data processing path. In addition, the complex ratio of the two (data/memory) or the difference (data–memory) can also be selected. If memory is displayed, the data from the memory arrays goes through exactly the same data processing flow path as the data from the data arrays. Refer to “**DISPLAY** KEY” in Chapter 6 for information on memory math functions.

The Delay Block (Electrical Delay)

This involves adding or subtracting a linear phase in proportion to frequency. This is equivalent to “line-stretching” or artificially moving the measurement reference plane. Refer to “**SCALE REF** KEY” in Chapter 6 for details.

Conjugate Matching

This simulates matching circuits at the end of the DUT in order to match the DUT to the system characteristic impedance. Parameters of the provided matching circuits will be calculated.

Conversion Transforms

This transforms the measured S-parameter data to the equivalent complex impedance (Z) or admittance (Y) values, or to inverse S-parameters (1/S). Refer to “Conversion Menu” in Chapter 6

Unformat Data Arrays

This arrays hold the complex number pairs which will be converted into a scalar number in the next stage. The arrays are accessible using the internal disk drive.

Formatting

This converts the complex number pairs into a scalar representation for display, according to the selected format. This includes group delay calculations. These formats are often easier to interpret than the complex number representation. (Polar and Smith chart formats are not affected by the scalar formatting.) Note that after formatting, it is impossible to recover the complex data. Refer to “**FORMAT** KEY” in Chapter 6 for information on the different formats available and on group delay principles.

Smoothing

This is one of the noise reduction techniques, that smooths noise on the trace. When smoothing is on, each point in a sweep is replaced by the moving average value of several adjacent (formatted) points. The number of points included depends on the user defined

smoothing aperture. The effect is similar to video filtering. If data and memory are displayed, smoothing is performed on both data and memory traces. Refer to “**AVG** KEY” in Chapter 6 for information about smoothing.

Format Arrays

The results so far are stored in the format arrays. It is important to note that marker values and marker functions are all derived from the format arrays. Limit testing is also performed on the formatted data. The format arrays are accessible via HP-IB, or using the internal disk drive.

Scaling

These operations prepare the formatted data for display on the CRT. This is where the reference line position, reference line value, and scale calculations are performed, as appropriate to the format. Refer to “**SCALE REF** KEY” in Chapter 6.

Display Memory

The display memory stores the display image for presentation on the display. The information here includes graticules, annotation, and softkey labels - everything visible on the display. When the display is printed or plotted, the information sent to the printers or plotter is taken from display memory. Finally, the display memory data is sent to the display.

Contents

2. Front and Rear Panel	
INTRODUCTION	2-1
ACTIVE FUNCTION	2-1
FRONT PANEL KEYS AND SOFTKEY MENUS	2-1
Softkeys that are Joined by Vertical Lines	2-2
Softkeys That Toggle On or Off	2-2
Softkeys that Show Status Indications in Brackets	2-2
Function Key Blocks	2-2
Stimulus Block	2-2
Response Block	2-2
Instrument State Block	2-2
HP-IB Control	2-3
Information on Keys and Softkeys	2-3
FRONT PANEL FEATURES	2-4
CRT DISPLAY	2-6
REAR PANEL FEATURES AND CONNECTORS	2-9

Figures

2-1. HP 8751C Front Panel	2-4
2-2. CRT Display (Single Channel, Cartesian Format)	2-6
2-3. HP 8751A Rear Panel	2-9

Front and Rear Panel

INTRODUCTION

This chapter describes the analyzer operation using its front panel controls, and explains the use of softkey menus. It provides illustrations and descriptions of the front panel features, the CRT display and its labels, and the rear panel features and connectors.

Analyzer functions are activated from the front panel by the operator using front panel keys or softkeys. In this manual, all front panel keys and softkey labels are shown as **Hardkey** and **Softkey**.

ACTIVE FUNCTION

The function currently activated is called the active function, and is displayed in the active entry area at the upper left of the display. As long as a function is active it can be modified with the ENTRY keypad (refer to "ENTRY BLOCK KEYS" in Chapter 4). A function remains active until another function is selected, or **ENTRY OFF** is pressed.

FRONT PANEL KEYS AND SOFTKEY MENUS

Some of the front panel keys change instrument functions directly, and others provide access to additional functions available in softkey menus. Softkey menus are lists of up to eight related functions that can be displayed in the softkey label area at the right-hand side of the display. The eight keys to the right of the CRT are the softkeys. Pressing one of the softkeys selects the adjacent menu function. This either executes the labeled function and makes it the active function, causes instrument status information to be displayed, or presents another softkey menu.

Some of the analyzer's menus are accessed directly from front panel keys, and some from other menus. For example, the stimulus menu accessed by pressing the **MENU** key presents all the stimulus functions such as sweep type, number of points, power, sweep time, and trigger. Pressing **NUMBER of POINTS** allows the required number of points per sweep to be entered directly from the number pad. The **RETURN** softkeys returns to previous menus, while **DONE** both indicates completion of a specific procedure and returns to an earlier menu.

Usually, whenever a menu changes, the present active function is cleared, unless it is an active marker function.

Softkeys that are Joined by Vertical Lines

In cases where several possible choices are available for a function, they are joined by vertical lines. For example, in the input menu under the **MEAS** key, the available inputs and input ratios are listed: A, B, R, A/R, B/R, A/B, and only one can be selected at a time. When a selection has been made from the listed alternatives, that selection is underlined until another selection is made.

Softkeys That Toggle On or Off

Some softkey functions can be toggled ON or OFF, for example averaging, and this is indicated in the softkey label. The current state, ON or OFF, is capitalized in the softkey label.

Example:

AVERAGING ON off

The word ON is capitalized, showing that averaging is currently on.

AVERAGING on OFF

The word OFF is capitalized, showing that averaging is currently off.

Softkeys that Show Status Indications in Brackets

Some softkey labels show the current status of a function in brackets. These include simple toggle functions and status-only indicators. An example of a toggled function is the **PLOT SPEED [FAST]** or **PLOT SPEED [SLOW]** softkey. The **IF BW** softkey is an example of a status-only indicator, where the selected value of the IF bandwidth is shown in brackets in the softkey label.

Function Key Blocks

The front panel keys that provide access to softkey menus are grouped into the STIMULUS, RESPONSE, and INSTRUMENT STATE function blocks.

Stimulus Block

The stimulus block keys and softkey menus control all the functions of the test signal source.

Response Block

The response block keys and softkey menus control the measurement and display functions specific to the active channel.

Instrument State Block

The instrument state block keys and softkey menus control channel-independent system function such as printing and plotting, save/recall, and HP-IB controller mode. In addition, major features such as limit testing, and Instrument BASIC (Option 002) are accessed under the **SYSTEM** key.

The Instrument BASIC allows a BASIC program entry using a full keyboard, to automate DUT measurement. Instrument BASIC may also be configured to run automatically at power on. This function also allows the operator to control external HP-IB instrument from the

analyzer. *The Instrument BASIC Operation Manual*, included in Option 002, describes this feature.

HP-IB Control

The functions accessible from the front panel can also be accessed remotely by an external controller using HP-IB, or the Instrument BASIC function (Option 002). Equivalent HP-IB commands are available for most of the front panel keys and softkey menu selections. The HP-IB programming command equivalent to each front panel and softkey function is provided in parentheses after the first reference. Additional information about HP-IB programming is provided in *HP-IB Programming Manual*.

Information on Keys and Softkeys

The following chapters describe all the front panel keys and softkey menus in detail. The purpose and use of each function is detailed, together with expected indications and results, allowable values, and possible limitations. This information is presented in function block order. Each function block is illustrated and described in general terms. This is followed by information about each front panel key in the function block, together with a map and description of all the menus accessed from that key. Each menu is illustrated, and each softkey function in each menu is explained in detail. A complete map of the softkey menu structure is provided in Appendix B at the end of this reference, together with an alphabetical index.

FRONT PANEL FEATURES

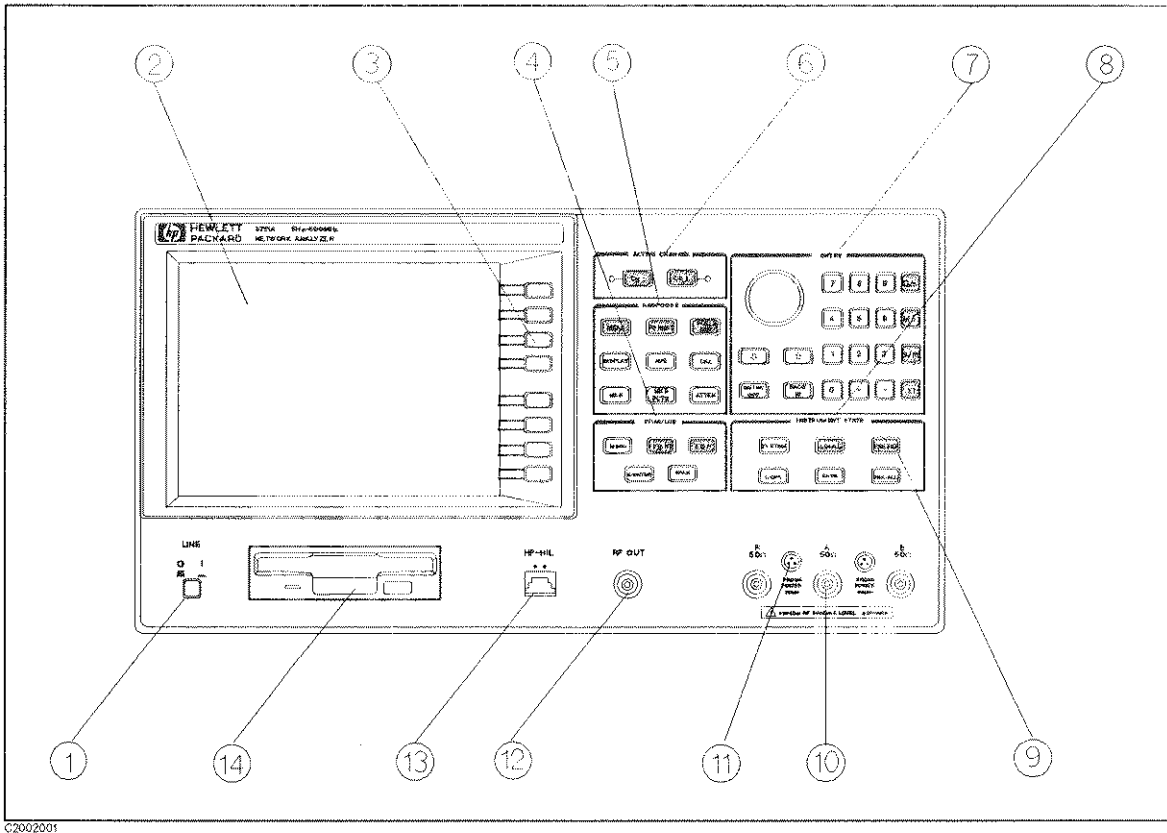

Figure 2-1. HP 8751C Front Panel

Figure 2-1 illustrates the following features and function blocks of the analyzer front panel. These features are described in more detail in this and subsequent chapters.

Caution



A properly grounded AC outlet is mandatory when operating the analyzer. Operating the instrument with an improperly grounded or floating ground prong *WILL DAMAGE THE INSTRUMENT!*

1. *LINE switch*. This controls AC power to the analyzer. 1 is ON, 0 is OFF.
2. *CRT display*. This is used for display of data traces, measurement annotation, softkey labels, and other information. The display is divided into specific information areas, illustrated in Figure 2-2.
3. *Softkeys*. These keys expand the capabilities of the analyzer with additional functions beyond those of the front panel keys. They provide access to menu selections displayed on the CRT.
4. *STIMULUS function block*. The keys in this block control the RF signal from the analyzer's source, and other stimulus functions.
5. *RESPONSE function block*. The keys in this block control the measurement and display functions of the active display channel.

6. *ACTIVE CHANNEL keys.* These keys select the active channel from two independent display channels. Any functions then entered apply to this active channel.
7. *The ENTRY block includes the knob, the step (↑) (↓) keys, and the number pad.* These are for entering numerical data and controlling the marker.
8. *INSTRUMENT STATE function block.* These keys control channel-independent system functions such as the following:
 - Limit testing (under the **SYSTEM** key).
 - Real time clock setting (under the **SYSTEM** key).
 - Instrument BASIC (Option 002) (under the **SYSTEM** key).
 - Changing the HP-IB addresses used by the analyzer when controlling external devices (printer, plotter). This done through the **LOCAL** key.
 - Printing and plotting (under the **COPY** key).
 - Save/Recall, under their respective keys.
9. **PRESET** key. This key returns the instrument to a known standard preset state from any step of any manual procedure. A complete listing of the instrument preset conditions is provided in Appendix A.
10. *Network analyzer inputs R, A, and B.* These receive input signals from a test set, source, or device under test. Input R is used as the reference input, Input B is also used as the dc voltage input. The input impedance of each input is 50 Ω.
11. *PROBE POWER connector.* This connector (fused inside the instrument) supplies power to an active probe for in-circuit measurements of AC circuits. Applicable active probes are described in the General Information section.
12. *RF OUT connector.* This connects the RF output signal from the analyzer's internal source to a test set or power splitter. The output impedance of this connector is 50 Ω.
13. *HP-HIL connector.* This connects the keyboard to use the Instrument BASIC.
14. *Built-in Flexible Disk Drive.* This stores the data measured, instrument status, list sweep tables, and Instrument BASIC programs. Disk format is LIF (logical interchange format).

CRT DISPLAY

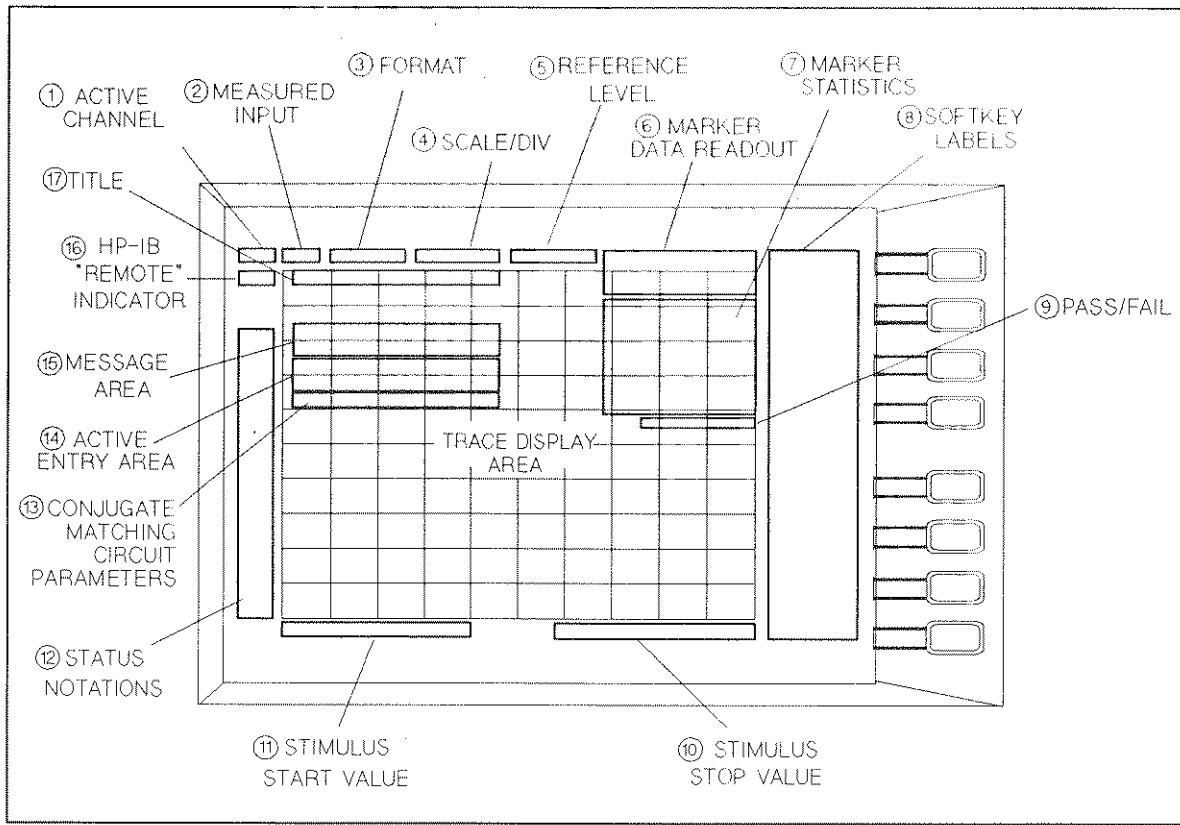

Figure 2-2. CRT Display (Single Channel, Cartesian Format)

The CRT displays the grid on which the measurement data is plotted, the currently selected measurement traces, and other information describing the measurement. Figure 2-2 illustrates the locations of the different CRT information labels, described below.

In addition to the full-screen display shown in Figure 2-2, a split display is available, as described under “**DISPLAY** KEY” in Chapter 6. In this case, information labels are provided for each half of the display.

Several different display formats for different measurements are illustrated and described in “**FORMAT** KEY” in Chapter 6.

The screen can be also used for the Instrument BASIC display. The Instrument BASIC uses a full-screen display or a half-screen display below a graticule display.

The following describe the information labels in detail.

1. *Active Channel* is the number of the current active channel, selected with the **ACTIVE CHANNEL** keys. If dual channel is ON with an overlaid display, both channel 1 and channel 2 appear in this area.
2. *Measured Input(s)* shows the S-parameter, input, or ratio of inputs currently measured, as selected using the **MEAS** key. The current display memory status is also indicated in this area.

3. *Format* is the display format selected using the **FORMAT** key.
4. *Scale/Div* is the scale selected using the **SCALE REF** key, in units appropriate to the current measurement.
5. *Reference Level* is the value of a reference line in Cartesian formats or the outer circle in polar formats, selected using the **SCALE REF** key. However the reference line is invisible, it is indicated by a small triangle adjacent to the graticule at the left.
6. *Marker Data Readout* are the values of the active marker, in units appropriate to the current measurement. Refer to Chapter 8.
7. *Marker Statistics, Width Value* are statistical marker values determined using the menus accessed with the **MKR FCTN** key. Refer to Chapter 8 .
8. *Softkey Labels* are menu labels displayed on the CRT that redefine the function of the softkeys immediately to the right of the CRT.
9. *Pass/Fail* are used for limit testing using limit line. Refer to “LIMIT LINE AND LIMIT TESTING” in Chapter 9.
10. *Stimulus Stop Value* is the stop frequency of the source in frequency domain measurements, or the upper limit of a power sweep. When the stimulus is in center/span mode, the span is shown in this space. The stimulus values can be blanked, as described under “**DISPLAY** KEY” in Chapter 6.
11. *Stimulus Start Value* is the start frequency of the source in frequency domain measurements, or the lower power value in power sweep. When the stimulus is in center/span mode, the center stimulus value is shown in this space.

(For power sweep measurements, the CW frequency is displayed centered between the start and stop power values.)

12. *Status Notations* is the current status of various functions for the active channel. The following notations are used:
- | | |
|-----|--|
| Avg | Sweep-to-sweep averaging is ON. The averaging count is shown immediately below (see “ AVG KEY” in Chapter 6). |
| Cor | Error correction is ON (see Chapter 7). |
| C? | Stimulus parameters have changed, and interpolated error correction is ON (see “ CAL Key” in Chapter 7). |
| C! | Stimulus parameters have changed, and interpolated error correction is not available (see “ CAL Key” in Chapter 7). |
| C2 | Two-port error correction is ON (see Chapter 7). |
| C2? | Two-port error correction is ON, but stimulus parameters have changed, and interpolated error correction is ON. |
| C2! | Two-port error correction is ON, but stimulus parameters have changed, and interpolated error correction is not available. |
| Del | Electrical delay, port extension, or phase offset has been added or subtracted (see “ SCALE REF KEY” in Chapter 6). |
| Cnj | Conjugate Matching is ON. |
| Ext | Waiting for an external trigger. |
| Hld | Hold sweep (see “Trigger Menu” in Chapter 5). |
| msH | “msH” indicates that the mechanical switch hold mode is engaged. The user has selected a mode of operation which would cause repeated switching of either the test port transfer switch in S-parameter test set or the mechanical switch in the analyzer. For more information refer to Chapter 5. |
| Svc | A service mode is turned on. If this notation is shown, the measurement data will be out of specifications. (Refer to <i>Maintenance Manual</i> .) |
| P↓ | Source power has been automatically set to minimum due to overload at the input (see “Power Menu” in Chapter 5). |
| Smo | Trace smoothing is ON (see “ AVG KEY” in Chapter 6). |
| * | Source parameters changed: measured data in doubt until a complete fresh sweep has been taken. |
13. *Conjugate Matching Circuit Parameters* are the derived parameters by the conjugate matching function. Refer to “Conjugate Matching Menu” in Chapter 6.
14. *Active Entry Area* displays the active function and its current value.
15. *Message Area* displays prompts or error messages.
16. *HP-IB “REMOTE” Indicator* displays “RMT” when the analyzer is in the remote state.
17. *Title* is a descriptive alpha-numeric string title defined by the user and entered as described at “Title Menu” in Chapter 6 under “**DISPLAY** KEY” in Chapter 6.

Note

The information provided here applies to Cartesian formats. In polar and Smith chart formats labeling may differ.

REAR PANEL FEATURES AND CONNECTORS

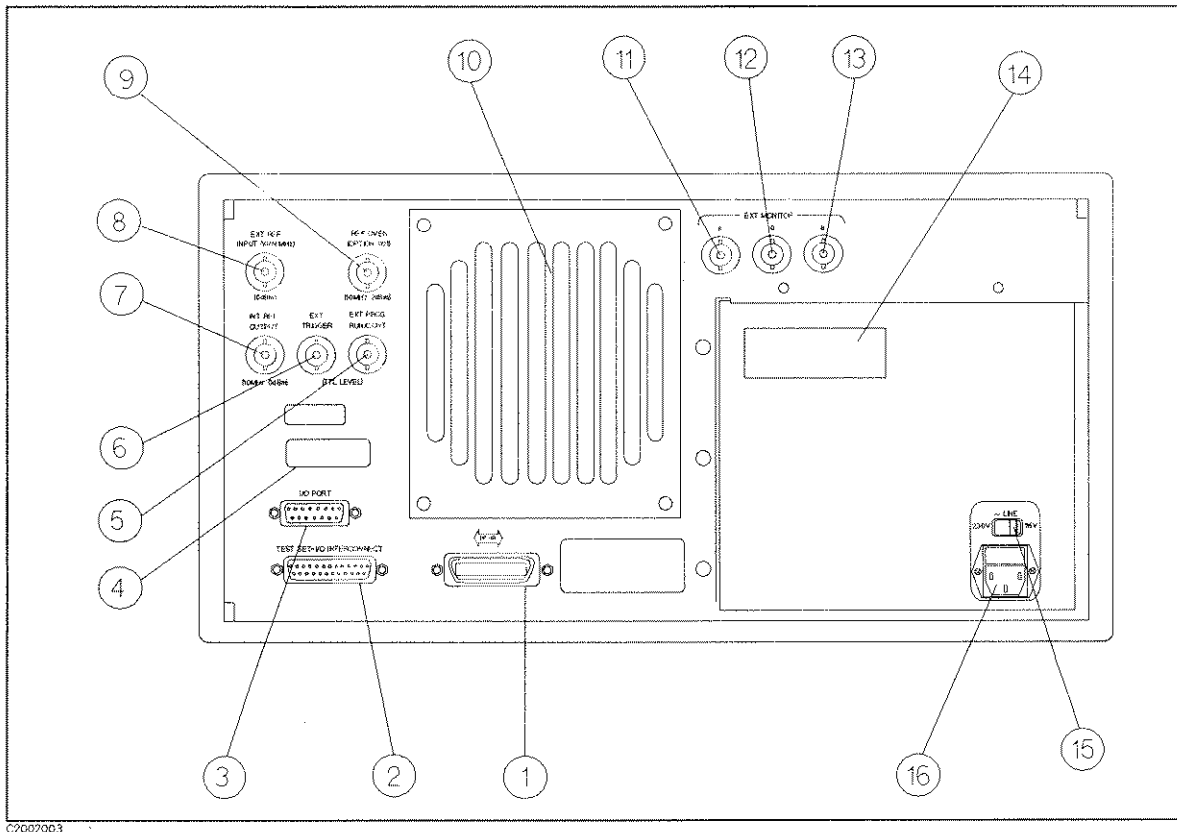

Figure 2-3. HP 8751A Rear Panel

Figure 2-3 illustrates the features and connectors of the rear panel, described below. Requirements for input signals to the rear panel connectors are provided in the General Characteristics table of the General Information and Specifications section.

1. *HP-IB connector.* This connects the analyzer to an external controller and other instruments in an automated system. This connector is also used when the analyzer itself is the controller of compatible peripherals. Refer to Chapter 12.
2. *TEST SET INTERCONNECT.* This connects the analyzer to an HP 87511A/B S-parameter test set using the interconnect cable supplied with the test set. The test set is then fully controlled by the analyzer. The HP 87512A/B transmission/reflection test kits do not use this interconnection.
3. *I/O port connector.* See Appendix C for complete information.

4. *Serial number plate.* For information about serial numbers, refer to “Instruments Covered by This Manual” in the General Information.
5. *EXT PROG RUN/CONT connector.* This externally triggers RUN or CONT of the Instrument BASIC program. At positive-going edge of a pulse more than 20 μ sec wide in the LOW status will trigger RUN or CONT. The signal is TTL-compatible.
6. *EXT TRIGGER connector.* This triggers a measurement sweep. At the positive-going edge of a pulse with more than 20 μ sec wide in the LOW status will start a measurement. The signal is TTL-compatible. To use this connector, set the trigger mode to external using softkey functions (see “Trigger Menu” in Chapter 5).
7. *INT REF OUTPUT connector.* This connects a frequency reference input of an external instrument to phase lock it to the HP 8751A.
8. *EXT REF INPUT connector.* This inputs a frequency reference signal to phase lock the analyzer to an external frequency standard for increased frequency accuracy.

When the HP 8751A is equipped with the external oven (Option 001), this connector must be connected to REF OVEN connector.

The external frequency reference feature is automatically enabled when a signal is connected to this input. When the signal is removed, the analyzer automatically switches back to its internal frequency reference.

9. *REF OVEN (Option 001) connector* connects to the EXT REF INPUT connector, when Option 001 is installed. Option 001 improves the frequency accuracy and stability of the analyzer.
10. *Fan.* This provides forced-air cooling for the analyzer.
11. *RED connector.*
12. *GREEN connector.*
13. *BLUE connector.* The red, green, and blue video output connectors provide analog red, green, and blue video signals which can drive an external color monitor such as the HP 3571B or monochrome monitor such as the HP 35731B. Other analog multi-sync monitors can be used if they are compatible with the analyzer’s 25.5 kHz scan rate and video levels: 1 Vp-p, 0.7 V = white, 0 V = black, -0.3 V sync, sync on green.

A monochrome display with applicable input specifications can also be connected to the BLUE connector.
14. *Safety warnings.*
15. *Line voltage selector switch.* Refer to “Line Voltage” in the User’s Guide.
16. *Power cord receptacle, with fuse.*

Contents

3. Active Channel Block	
ACTIVE CHANNEL KEYS	3-1

Figures

3-1. Active Channel Keys	3-1
------------------------------------	-----

Active Channel Block

ACTIVE CHANNEL KEYS

The analyzer has two digital channels for independent measurement and display of data. Two different sets of data can be measured simultaneously, for example the reflection and transmission characteristics of a device, or one measurement with two different frequency spans. The data can be displayed separately or simultaneously, as described below.

The HP-IB programming command is shown in parenthesis following the key or softkey.

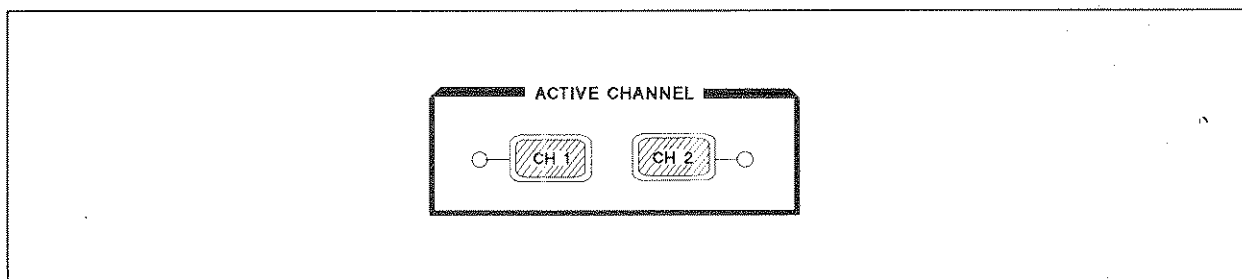

C2003001

Figure 3-1. Active Channel Keys

The **CH 1** (CHAN1) and **CH 2** (CHAN2) keys illustrated in Figure 3-1 select which channel is the *active channel*. This is the channel currently controlled by the front panel keys, and its trace and data annotations are displayed on the display. All channel specific functions selected apply to the active channel. The current active channel is indicated by an amber LED adjacent to the corresponding channel key.

The analyzer has dual trace capability, so that both the active and inactive channel traces can be displayed, either overlaid or on separate graticules (split display). The dual channel and split display features are available in the display menus. Refer to Chapter 6 for illustrations and descriptions of the different display capabilities.

Stimulus values can be coupled or uncoupled between the two channels, independent of the dual channel and split display functions. Refer to "**MENU** KEY" in Chapter 5 for a listing of the source values that are coupled in stimulus coupled mode.

Another coupling capability is coupled markers. Measurement markers can have the same stimulus values for the two channels, or they can be uncoupled for independent control in each channel. Refer to Chapter 8 for more information about markers.

Contents

4. Entry Block	
ENTRY BLOCK KEYS	4-1

Figures

4-1. Entry Block 4-1

Entry Block

ENTRY BLOCK KEYS

The ENTRY block, illustrated in Figure 4-1, provides the numeric and units keypad, the knob, and the step keys. These are used in combination with other front panel keys and softkeys to modify the active entry, to enter or change numeric data, and to change the value of the active marker. In general the keypad, knob, and step keys can be used interchangeably.

Before a function can be modified, it must be made the active function by pressing a front panel key or softkey. It can then be modified directly with the knob, the step keys, or the digits keys and a terminator, as described below.

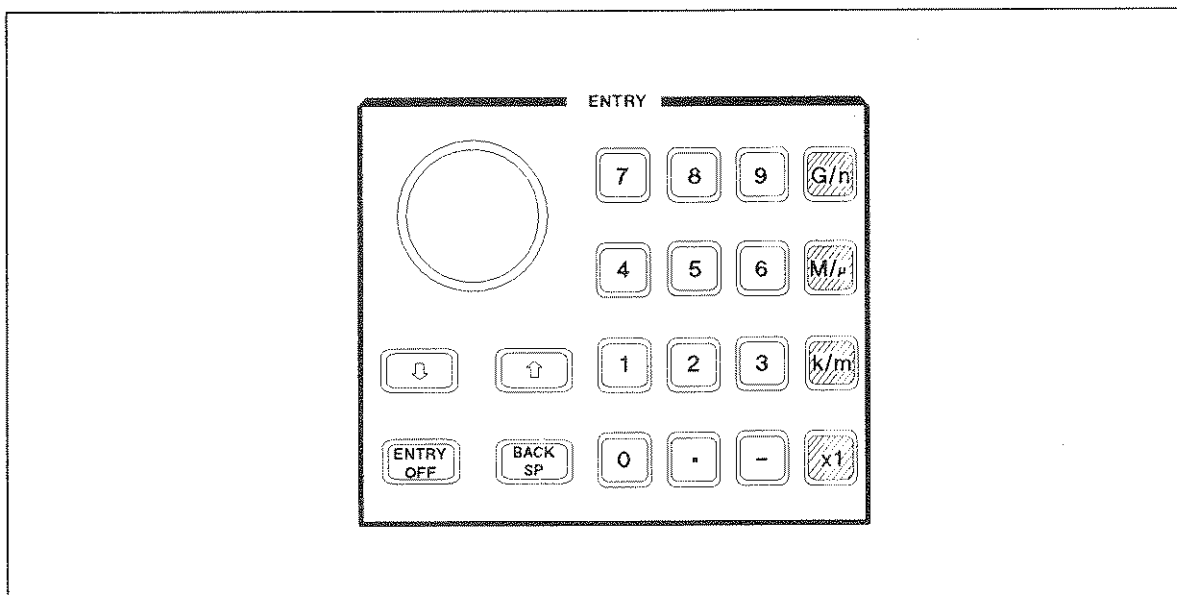

Figure 4-1. Entry Block

The numeric keypad selects digits, decimal point, and minus sign for numerical entries. A units terminator is required, as described below. The HP-IB programming command is shown in parenthesis following the key or softkey.

The units terminator keys are the four keys in the right-hand column of the keypad. These specify units of numerical entries from the keypad and at the same time terminate the entries. A numerical entry is incomplete until a terminator is supplied, and this is indicated by the data entry arrow “←” pointing at the last entered digit in the active entry area. When the units terminator key is pressed, the arrow is replaced by the units selected. The units are abbreviated on the terminator keys as follows:

G/n (G, N, KEY 43)	Giga/nano ($10^9 / 10^{-9}$)
M/μ (MA, U, KEY 42)	Mega/micro ($10^6 / 10^{-6}$)
k/m (K, M, KEY 41)	kilo/milli ($10^3 / 10^{-3}$)
x1 (KEY 40)	basic units: dB, dBm, degrees, seconds, Hz, or dB/GHz (may be used to terminate unitless entries such as averaging factor). No HP-IB commands must be required.

Note The suffix unit MHZ is a special case which should not be confused with MAHZ or mHZ.



The knob adjusts continuously to current values for various functions such as scale, reference level, and others. If a marker is turned on, and no other function is active, the knob can adjust the marker position. Values changed by the knob are effective immediately, and require no units terminator.

The step keys **↓** (KEY 24) and **↑** (KEY 25) step the current value of the active function up or down. The steps are predetermined and cannot be altered. No units terminator is required with these two keys.

ENTRY OFF (KEY 26) clears and turns off the active entry area, as well as any displayed prompts, error messages, or warnings. Use this function to clear the display before plotting. This key also prevents changing of active values by accidentally moving the knob. The next selected function turns the active entry area back on.

BACK SPACE key (KEY 27) deletes the last entry, or the last digit entered from the numeric keypad.

Contents

5. Stimulus Function Block	
INTRODUCTION	5-1
MECHANICAL SWITCH HOLD	5-2
Output Power Switch	5-2
Test Port Transfer Switch	5-2
MEASURE RESTART and NUMBER OF GROUPS Softkeys	5-2
START, STOP, CENTER, AND SPAN KEYS	5-3
MENU KEY	5-4
Stimulus Menu	5-5
Power Menu	5-7
Sweep Time Menu	5-8
Trigger Menu	5-10
Sweep Type Menu	5-11
List Sweep Menu	5-13
Edit List Menu	5-13
Edit Segment Menu	5-14
Edit Segment More Menu	5-16
Clear List Menu	5-17

Figures

5-1. Stimulus Function Block	5-1
5-2. Softkey Menus Accessed from the MENU Key	5-4
5-3. Stimulus Menu	5-5
5-4. Power Menu	5-7
5-5. Sweep Time Menu	5-8
5-6. Trigger Menu	5-10
5-7. Sweep Type Menu	5-11
5-8. List Sweep Menu	5-13
5-9. Edit List Menu	5-14
5-10. Edit Segment Menu	5-15
5-11. Edit Segment More Menu	5-16
5-12. Clear List Menu	5-17

Tables

5-1. Minimum Sweep Time In Seconds (Typical Value)	5-9
--	-----

Stimulus Function Block

INTRODUCTION

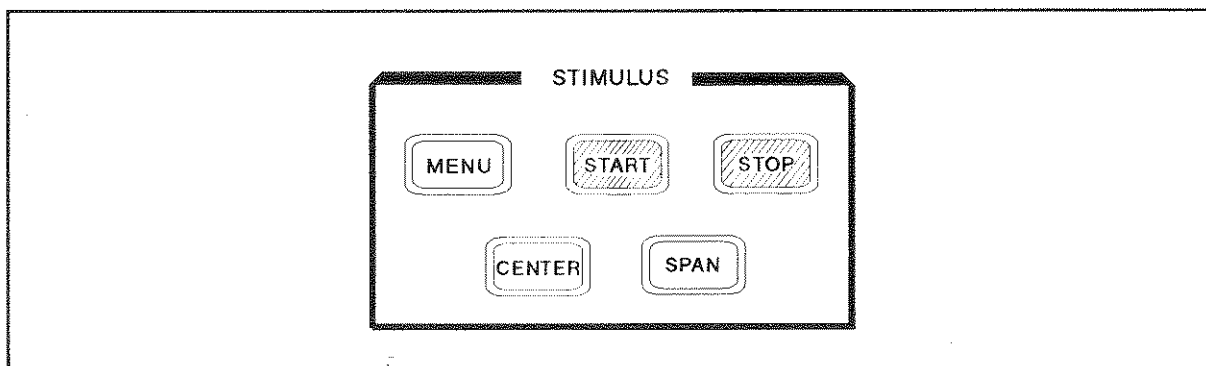

C2005001

Figure 5-1. Stimulus Function Block

The stimulus function block keys and associated menus define and control the source RF output signal to the device under test. The source signal can be swept over any portion of the instrument's frequency and power range. The menus set all other source characteristics such as sweep time and resolution, source RF power level, the number of data points taken during the sweep, and S-parameter test set attenuation.

Note

Refer to the Specifications in the *GENERAL INFORMATION* for some power sweep range restrictions.

The HP-IB programming command is shown in parenthesis following the key or softkey.

MECHANICAL SWITCH HOLD

Output Power Switch

A mechanical switch in the analyzer sets the output power level. When the dual channel is ON and the power levels of each channel is different, measurement configuration requires continuous switching. But to avoid premature wearing out of the output power switch, continuous switching is not allowed, and the notation “msH” is displayed at the left of the screen. (If averaging is ON, the hold mode will not engage until the specified number of sweeps are completed.)

Test Port Transfer Switch

An S-parameter test set can only send power to one test port at a time. A mechanical transfer switch in the test set sends power to either port 1 or port 2. To avoid premature wearing out of the transfer switch, measurement configurations requiring continuous switching are not allowed. The following examples explain how the analyzer prevents continuous switching:

- A full two-port calibration requires all four S-parameters be measured for each sweep. This would require the transfer switch to engage twice each sweep. To prevent continuous switching, only the first measurement uses the transfer switch to measure all four S-parameters. Subsequent sweeps do not use the switch and only two S-parameters are measured. The **MEASURE RESTART** and **NUMBER of GROUPS** softkeys can override this protection feature and allow measurement of all four S-parameters.
- When port 1 and port 2 are driven by different channels and dual channel display is turned on, the transfer switch would switch repeatedly between channels. To prevent continuous switching, the analyzer automatically engages the test set hold mode. (The status annotation “msH” appears on the left side of the display.) If averaging is ON, the hold mode will not engage until the specified number of sweeps are completed. The **MEASURE RESTART** and **NUMBER of GROUPS** softkeys can override this protection feature and allow switching to occur.

MEASURE RESTART and **NUMBER of GROUPS** Softkeys

These softkeys allow measurements which demand repetitive switching of the mechanical transfer switch. Use these softkeys with caution, repetitive switching will cause premature wearing out of the switches.

- **MEASURE RESTART** causes one measurement to occur.
- **NUMBER of GROUPS** causes a specified number of measurements to occur.

These softkeys are explained in detail later in this chapter.

START, STOP, CENTER, AND SPAN KEYS

The HP-IB programming command is shown in parenthesis following the key or softkey.

START (STAR)

STOP (STOP)

CENTER (CENT)

SPAN (SPAN)

These keys define the frequency range or power range of the stimulus. The range can be expressed as either start/stop or center/span. When one of these keys is pressed, its function becomes the active function. The value is displayed in the active entry area and can be changed with the knob, step keys, or numeric keypad. Current stimulus values for the active channel are also displayed along the bottom of the graticule. Frequency values can be a blank for security purposes, using the display menus.

The preset stimulus mode is frequency, and the start and stop stimulus values are set to 5 Hz (or 100 kHz when an S-parameter test set is connected) and 500 MHz respectively. In power sweep, the stimulus value is in dBm.

Because the display channels are independent, the stimulus signals for the two channels can be uncoupled and their values set independently. The values are then displayed separately on the display if the analyzer is in dual channel display mode. In the uncoupled mode with dual channel display the analyzer takes alternate sweeps to measure the two sets of data. Channel stimulus coupling is explained in this chapter, and dual channel display capabilities are explained in Chapter 6 .

MENU KEY

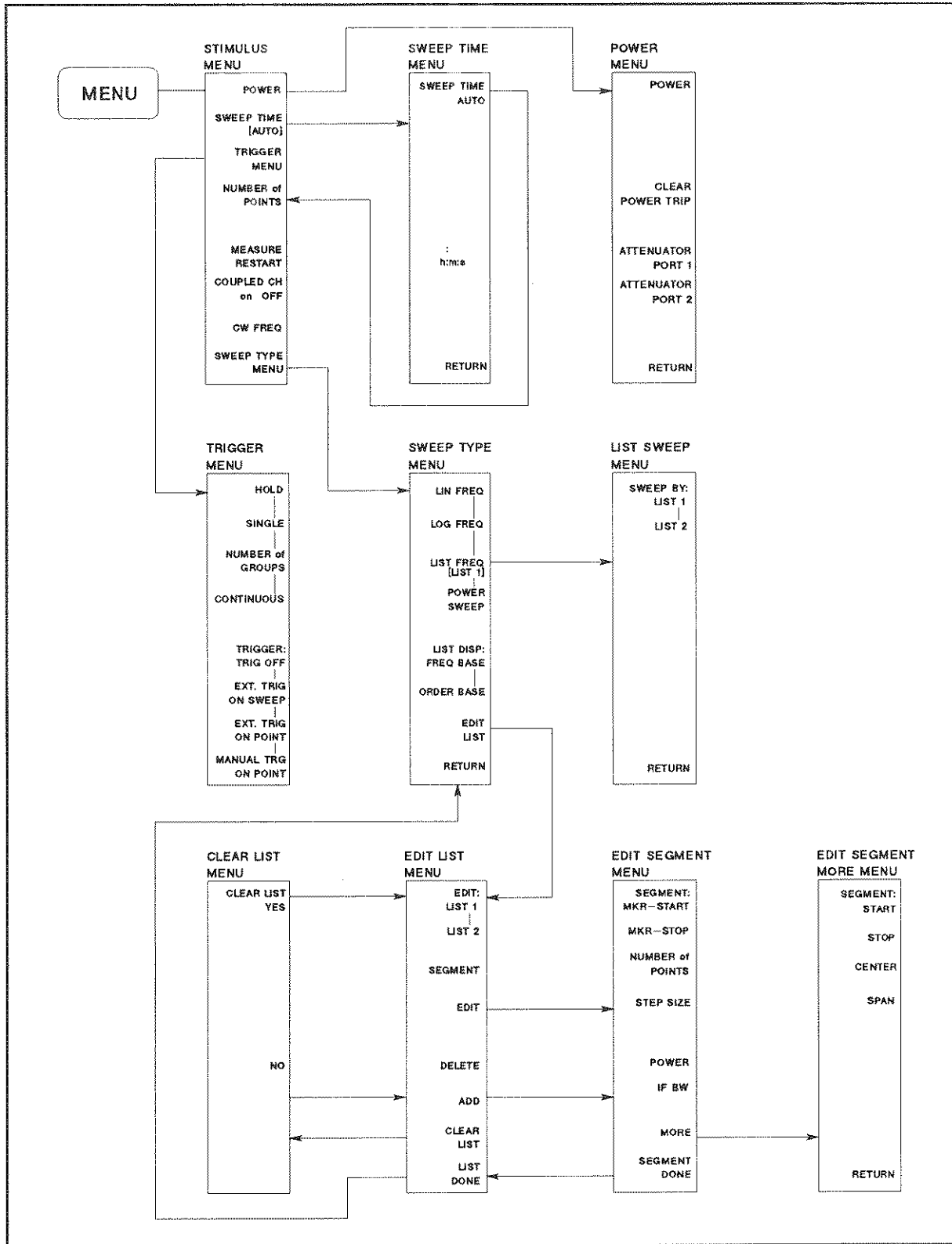

C2005012

Figure 5-2. Softkey Menus Accessed from the **MENU** Key

5-4 Stimulus Function Block

The HP-IB programming command is shown in parenthesis following the key or softkey.

The **MENU** (KEY 19) key provides access to the series of menus illustrated in Figure 5-3, which define and control all stimulus functions other than start, stop, center, and span. When the **MENU** key is pressed, the stimulus menu is displayed. This in turn provides access to the other softkey menus. The functions available in these menus are described in the followings.

Stimulus Menu

The stimulus menu specifies the number of measurement points per sweep, and CW frequency. It includes the capability to couple or uncouple the stimulus functions of the two display channels, and the measurement restart function. In addition, it leads to other softkey menus that define power level, sweep time, trigger type, and sweep type. The individual softkey functions of the stimulus menu are described below.

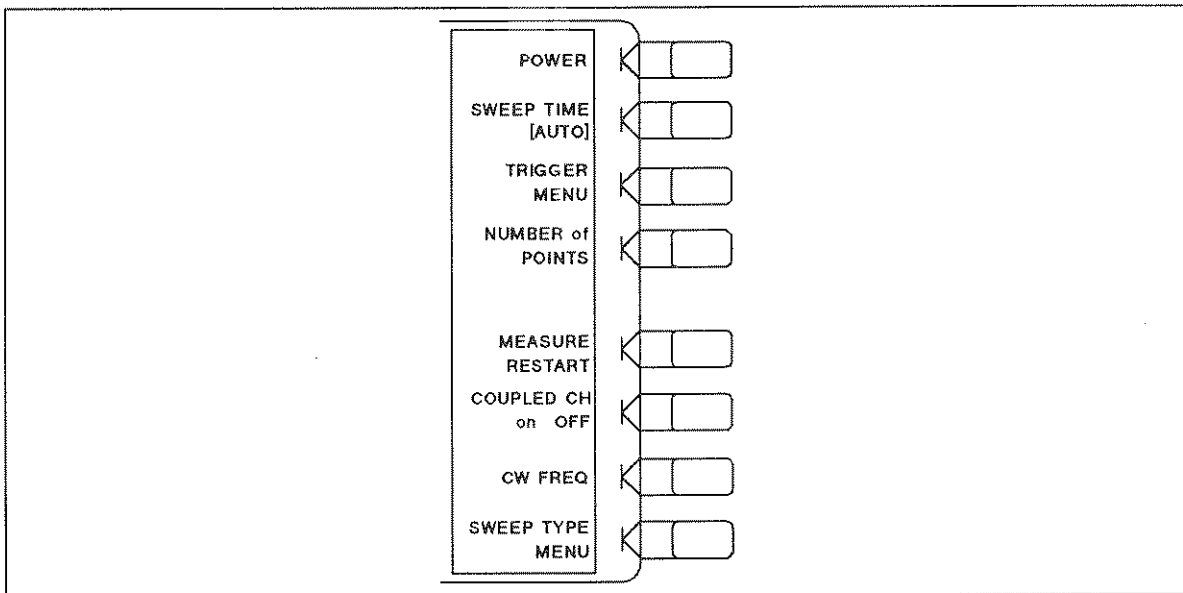

C2005002

Figure 5-3. Stimulus Menu

POWER (POWE) makes power level the active function and presents the power menu, which sets the output power level. The allowable power range is -50 dBm to $+15$ dBm.

SWEEP TIME [] presents the sweep time menu, which toggles between automatic and manual sweep time.

TRIGGER MENU presents the trigger menu, which selects the type of the sweep trigger.

NUMBER of POINTS (POIN) selects the number of data points per sweep. Using fewer points allows a faster sweep time but the displayed trace shows less horizontal detail. Using more points gives greater data density and improved trace resolution, but slows the sweep.

The possible values that can be entered for number of points are 2 through 801 with a step value of 1. The number of points can be different for the two channels if the stimulus values are uncoupled.

In list frequency sweep, the number of points displayed is the total number of frequency points for the defined list (see “Sweep Type Menu” in this chapter).

MEASURE RESTART (REST) aborts the sweep in progress, then restarts the measurement. This can update a measurement following an adjustment of the device under test. When a full two-port calibration is in use, the **MEASURE RESTART** key will initiate another update of both forward and reverse S-parameter data. This softkey will also override the test set hold mode, which inhibits continuous switching of the mechanical switch. The measurement configurations which cause this are described in “MECHANICAL SWITCH HOLD” at the beginning of this chapter. This softkey will override the test set hold mode for one measurement.

If the analyzer is taking a number of groups (see “Trigger Menu” in this chapter), the sweep counter is reset at 1. If averaging is ON, **MEASURE RESTART** resets the sweep-to-sweep averaging and is effectively the same as **AVERAGING RESTART**. If the sweep trigger is in the **HOLD** mode, **MEASURE RESTART** executes a single sweep. **COUPLED CH ON OFF** (COUCON, COUCOFF) toggles the channel coupling of stimulus values. With **COUPLED CH ON** (the preset condition), both channels have the same stimulus values (the inactive channel takes on the stimulus values of the active channel).

In the stimulus coupled mode, the following parameters are coupled:

- Frequency
- Number of points
- Source power level
- Number of groups
- IF bandwidth
- Sweep time
- Trigger type
- Sweep type
- List sweep table

If both channels have the same input parameter such as S_{11} or A/R, the following parameters are also coupled:

- Correction mode
- Calibration coefficient

The following parameters are always common to both channels, even if the stimulus mode is not coupled.

- External trigger mode
- Power trip (Refer to “Power Menu”)
- Input R, A, and B attenuator
- Calibration kit type and data

The following parameters are always set separately for each channel, even if the stimulus mode is coupled.

- Measurement parameter
- Display Format
- Title (on/off)
- Memory trace (on/off)
- Scale reference value
- Electrical delay

- Phase offset
- Conjugate matching (on/off, parameter)
- Averaging (on/off, factor)
- Smoothing (on/off, factor)

Coupling of stimulus values for the two channels is independent of **DUAL CHAN** on OFF in the display menu and **MARKERS: UNCOUPLED** in the marker mode menu. **COUPLED CH OFF** becomes an alternate sweep function when dual channel display is on: in this mode the analyzer alternates between the two sets of stimulus values for measurement of data and both are displayed.

CW FREQ (CWFREQ) sets the frequency for power sweep.

SWEEP TYPE MENU presents the sweep type menu, where one of the available types of stimulus sweep can be selected.

Power Menu

The power menu sets the output power level of the source.

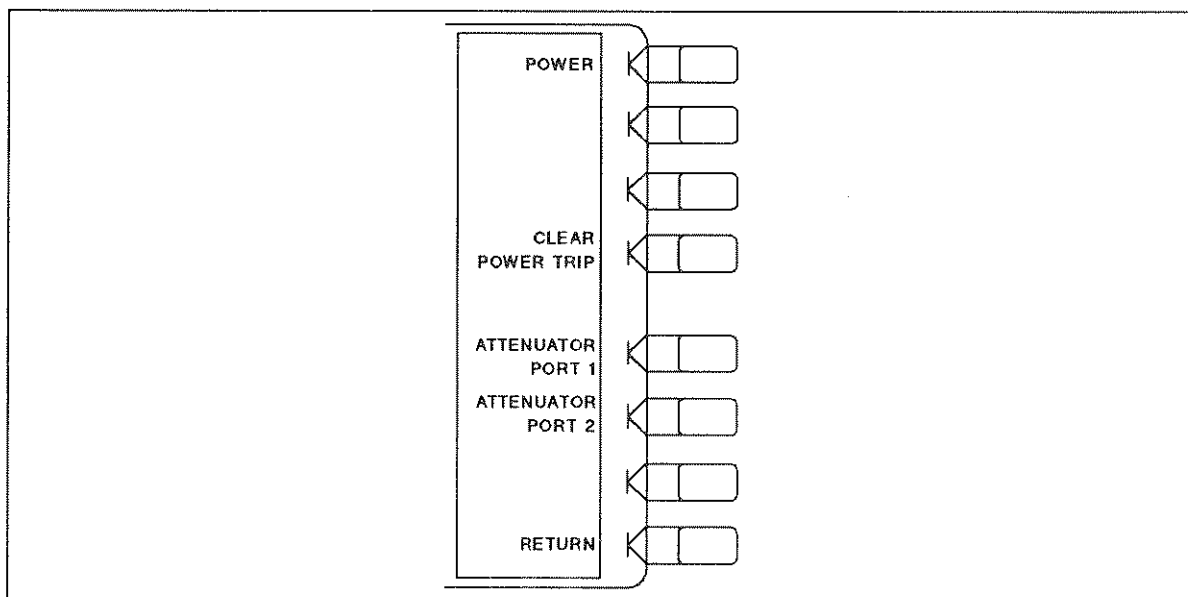

C2005003

Figure 5-4. Power Menu

POWER (POWE) makes power level the active function and sets the RF output power level of the analyzer's internal source. The allowable range is -50 dBm to $+15$ dBm. The analyzer will detect an input power overload at any of the three receiver inputs, and automatically reduces the output power of the source down several dBm. This is indicated with a message. In addition, the power trip is set, and the annotation "P!" appears at the left side of the display. When this occurs, reset the power to a lower level, and press **CLEAR POWER TRIP** (see below) to turn the power trip Off.

CLEAR POWER TRIP (CLEPTRIP) turns off the power trip function. Power trip is a reduced power state triggered by a power overload. It forces the source output power down several dBm regardless of the user-specified power level. The trip is set automatically whenever

a power overload is detected on an input channel. When trip is ON, the annotation “P|” appears in the status notation area of the display.

ATTENUATOR PORT 1 (ATTP1) and ATTENUATOR PORT 2 (ATTP2)

Note



These functions are for some S-parameter test sets with a programmable attenuator (e.g. HP 85046A/B) only. No warning is given if no test set is present, or if the test set has no programmable attenuator (as in the HP 87511A/B S-parameter Test Set).

These control the attenuation at port 1 and port 2 of an S-parameter Test Set with attenuator connected to the analyzer. The attenuator range is 0 to 70 dB, controllable in 10 dB steps.

Note



The analyzer does not allow port 1 and 2 to be set to different attenuator values. This is because the same attenuator is used for both ports, and is mechanically switched between them. To prevent premature wearing out, continuous switching of attenuator values between ports is not allowed.

RETURN goes back to the stimulus menu.

Sweep Time Menu

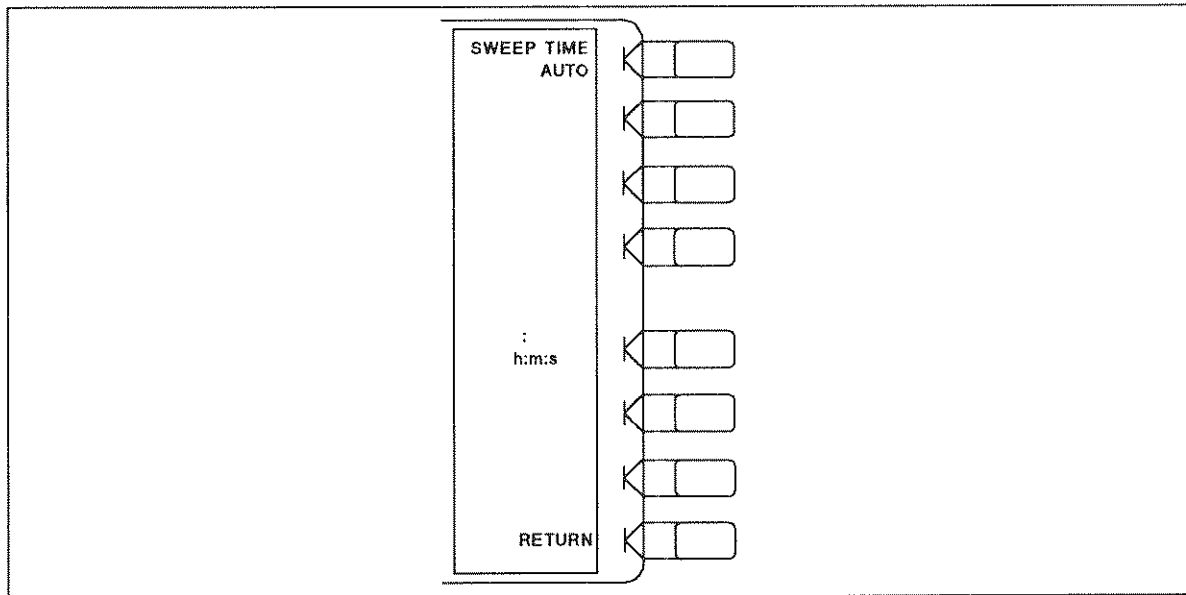

C2006004

Figure 5-5. Sweep Time Menu

SWEEP TIME (SWET) toggles between automatic and manual sweep time. The following explains the difference between automatic and manual sweep time:

- *Manual Sweep Time.* As long as the selected sweep speed is within the capability of the instrument, it will remain fixed, regardless of changes to other measurement parameters. If the operator changes measurement parameters such that the instrument can no longer

maintain the selected sweep time, the analyzer will change to the best sweep time possible. Manual mode is turned on by entering a sweep time.

- *Auto Sweep Time.* Auto sweep time continuously maintains the fastest sweep speed possible with the selected measurement parameters to satisfy the specifications. Auto sweep time is turned on by pressing SWEEP TIME AUTO (SWETAUTO) when manual sweep is on.

Sweep time refers only to the time that the instrument is sweeping and taking data, and does not include the time required for internal processing of the data. A sweep speed indicator “↑” is displayed on the trace for sweep times slower than 1.0 second.

Minimum sweep time. The minimum sweep time depends on several factors. These factors are referred to as “measurement parameters” in the following paragraphs.

- The number of points selected
- IF bandwidth

The following table is a partial guide for determining the minimum sweep time. The typical values listed represent the minimum time required for a measurement with averaging off. Values are given in seconds.

Table 5-1. Minimum Sweep Time In Seconds (Typical Value)

Number Of Points	IF Bandwidth				
	4 kHz	1 kHz	200 Hz	20 Hz	2 Hz
11	4.4 m	11 m	67.1 m	583 m	7.485
51	20.4 m	51 m	311.1 m	2.703	34.71
101	40.4 m	101 m	616.1 m	5.3	68
201	80.4 m	201 m	1.196	10.65	136
401	160.4 m	401 m	2.446	21.25	272
801	320.4 m	801 m	4.886	42.45	545

h:m:s inputs “:” for the manual sweep time entry.

RETURN goes back to the stimulus menu.

Trigger Menu

This menu selects the type of the sweep trigger.

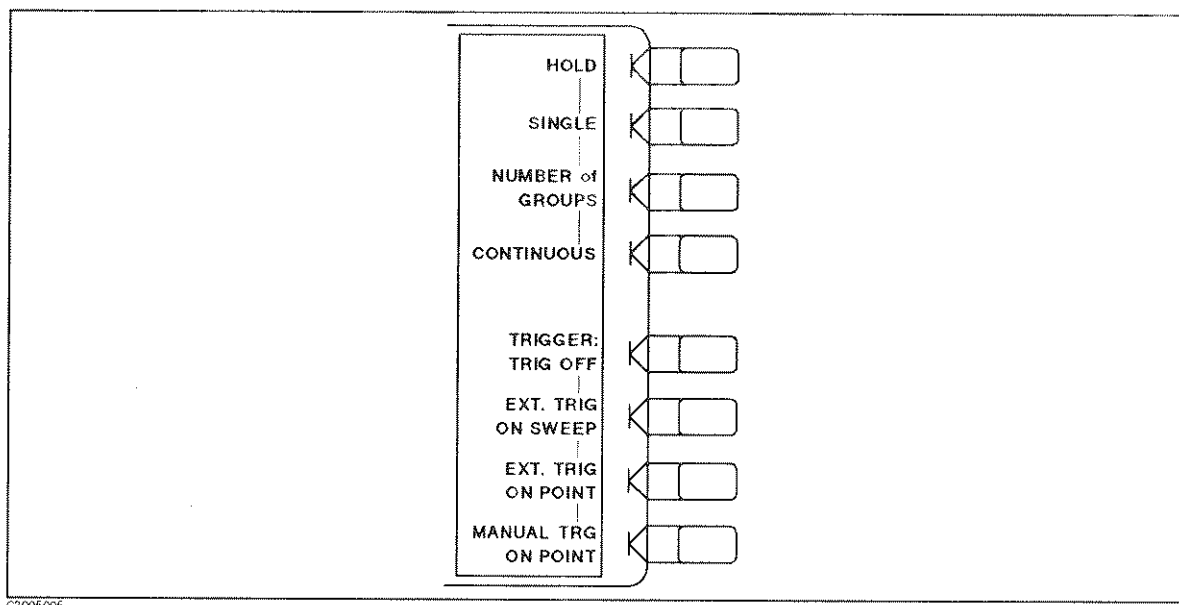

Figure 5-6. Trigger Menu

HOLD (HOLD) freezes the data trace on the display, and the analyzer stops sweeping and taking data. The notation “Hld” is displayed at the left of the graticule. If the “*” indicator is on at the left side of the display, trigger a new sweep using **SINGLE**.

SINGLE (SING) takes one sweep of data and returns to the hold mode.

NUMBER of GROUPS (NUMG) triggers a user-specified number of sweeps, and returns to the hold mode. This function can be used to override the test set hold mode, which protects the electro-mechanical switch against continuous switching. This is explained fully in “MECHANICAL SWITCH HOLD” in the beginning of this chapter.

Caution

Over use of this function may cause premature wearing out of the mechanical switch.



If averaging is ON, the number of groups should be at least equal to the averaging factor selected to allow measurement of a fully averaged trace. Entering a number of groups resets the averaging counter to 1.

CONTINUOUS (CONT) is the standard sweep mode of the analyzer, in which the sweep is triggered automatically and continuously and the trace is updated with each sweep.

TRIGGER: TRIG OFF (EXTTOFF) turns off external trigger mode.

EXT. TRIG ON SWEEP (EXTTON) is used when the sweep is triggered on an externally generated signal connected to the rear panel EXT TRIGGER input. The sweep is started with a low-to-high transition of a TTL signal. If this key is pressed when no external trigger

signal is connected, the notation “Ext” is displayed at the left side of the display to indicate that the analyzer is waiting for a trigger. When a trigger signal is connected, the “Ext” notation is replaced by the sweep speed indicator “↑” either in the status notations area or on the trace. External trigger mode is allowed in every sweep mode.

EXT. TRIG ON POINT (EXTTPOIN) is similar to the trigger on sweep, but triggers each data point in a sweep.

MANUAL TRG ON POINT (MANTRIG) waits for a manual trigger for each point. Subsequent pressing of this softkey triggers each measurement. The annotation “man” will appear at the left side of the display when the instrument is waiting for the trigger to occur.

Sweep Type Menu

Four sweep types are available:

- Linear frequency sweeps in Hz
- Logarithmic frequency sweeps in Hz
- Power sweeps in dBm
- List frequency sweep in Hz. Two independent lists are available.

Interpolated Error Correction. The interpolated error correction feature functions with all sweep types.

Interpolated error correction automatically turns on when the stimulus parameters are changed after measuring calibration data. Refer to Chapter 7 for more information on interpolated error correction.

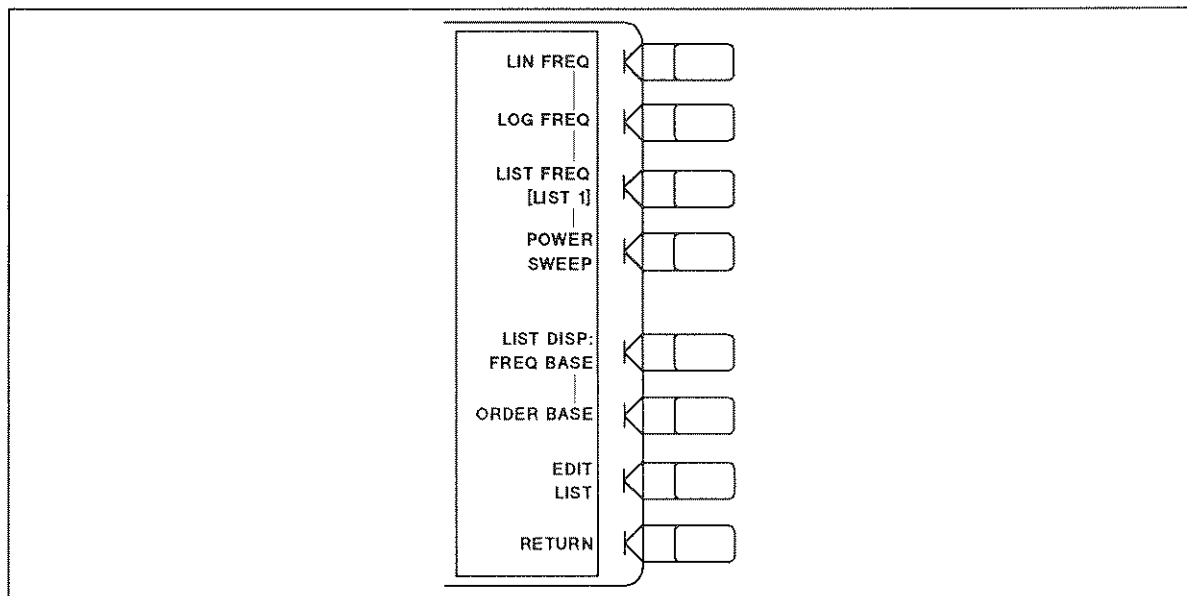

C2005006

Figure 5-7. Sweep Type Menu

LIN FREQ (LINFREQ) activates a linear frequency sweep mode. The data is displayed on a standard graticule with ten equal horizontal divisions. This is the default preset sweep type.

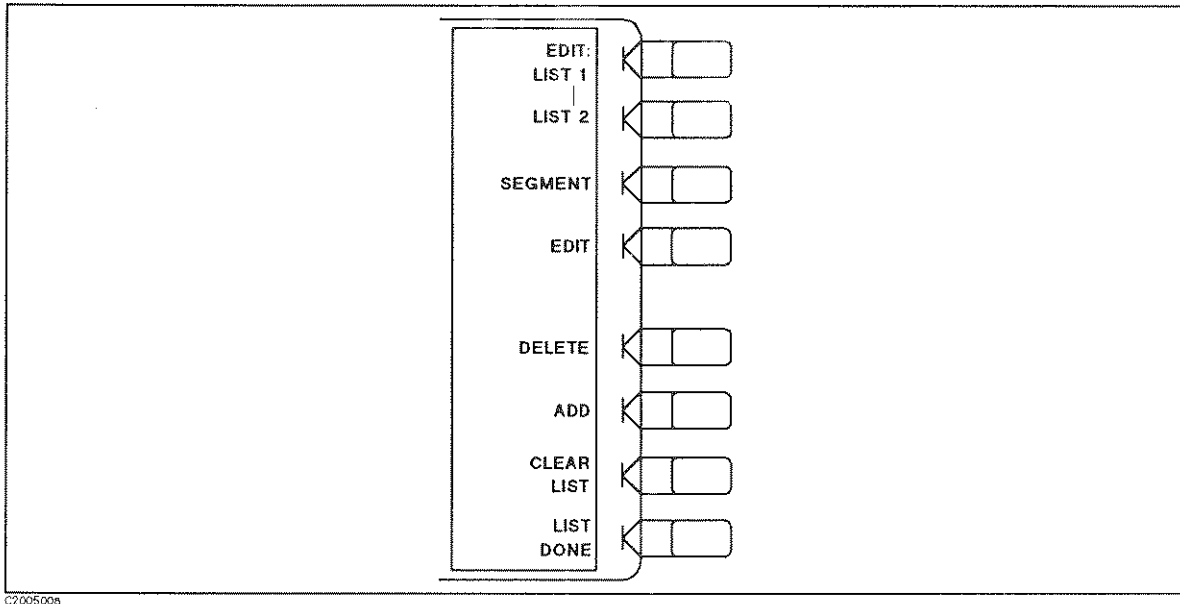

Figure 5-9. Edit List Menu

EDIT: LIST 1 (EDITLIS1) selects LIST 1 to edit.

LIST 2 (EDITLIS2) selects LIST 2 to edit.

SEGMENT (SEDI) determines a segment on the list to be modified. Enter the number of a segment in the list, or use the step keys to scroll the pointer ">" at the left to the required segment number. The indicated segment can then be edited or deleted.

EDIT provides the edit segment menu, where the segment indicated by the pointer ">" at the left can be modified.

DELETE (SDEL) deletes the segment indicated by the pointer ">".

ADD (SADD) adds a new segment to be defined with the edit segment menu. If the list is empty, a default segment is added, and the edit segment menu is displayed so it can be modified. If the list is not empty, the segment indicated by the pointer ">" is copied and the edit segment menu is displayed.

CLEAR LIST (CLEL) provides the clear list menu.

LIST DONE (EDITDONE) sorts the frequency points and returns to the sweep type menu.

Edit Segment Menu

This menu selects measurement frequencies arbitrarily. Using this menu it is possible to define the exact frequencies to be measured on a point-by-point basis. For example the sweep could include 100 points in a narrow passband, 100 points across a broad stop band, and 50 points across the third harmonic response. The total sweep is defined with a list of segments (subsweeps). Up to 31 segments can be defined, with a total of up to 801 data points.

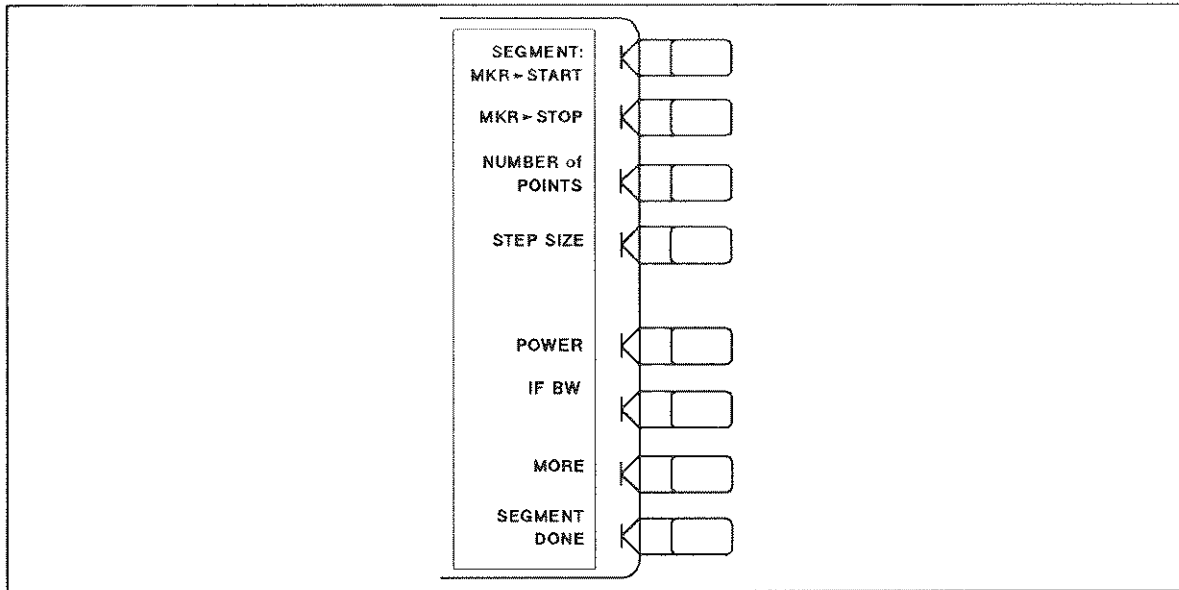

C2005009

Figure 5-10. Edit Segment Menu

The frequency segments, or segments, can be defined in any of the following terms:

- Start / stop / number of points
- Start / stop / step
- Center / span / number of points
- Center / span / step

The segments can overlap, and do not have to be entered in any particular order. The analyzer sorts the segments automatically and lists them on the display in order of increasing start frequency, regardless of the order in which they are entered. If duplicate frequencies exist, the analyzer makes multiple measurements on identical points to maintain the specified number of points for each segment. The data is displayed as a single trace that is a composite of all data taken when the list display function is frequency base.

The list frequency sweep mode is selected with the **LIST FREQ** softkey in the sweep type menu.

The frequency list parameters can be saved with the built-in floppy disk. (Refer to Chapter 11.)

Note



Not only the softkeys described below, use also the **START**, **STOP**, **CENTER**, and **SPAN** keys to define the stimulus range.

MKR → **START** (MARKSTAR) sets the stimulus start value to the stimulus value of the active marker.

MKR → **STOP** (MARKSTOP) sets the stimulus stop value to the stimulus value of the active marker.

NUMBER of POINTS (POINT) sets the number of points for the segment. The total number of points for all the segments cannot exceed 801.

STEP SIZE (STPSIZ) specifies the segment in frequency steps instead of number of points. Changing the start frequency, stop frequency, span, or number of points may change the step size. Changing the step size may change the number of points and stop frequency in start/stop/step mode; or the frequency span in center/span/step mode. In each case, the frequency span becomes a multiple of the step size.

SEGMENT:POWER (POWE) sets power level for segment by segment. The allowable range is -50 dBm to +15 dBm and maximum span is 35 dB.

IF BW (IFBW) sets IF bandwidth for segment by segment. The allowable bandwidth are 2, 20, 200, 1 k, and 4 kHz.

MORE goes to the edit segment more menu, which allows key in the stimulus range, **START**, **STOP**, **CENTER**, and **SPAN**.

SEGMENT DONE (SDON) returns to the edit list menu.

Edit Segment More Menu

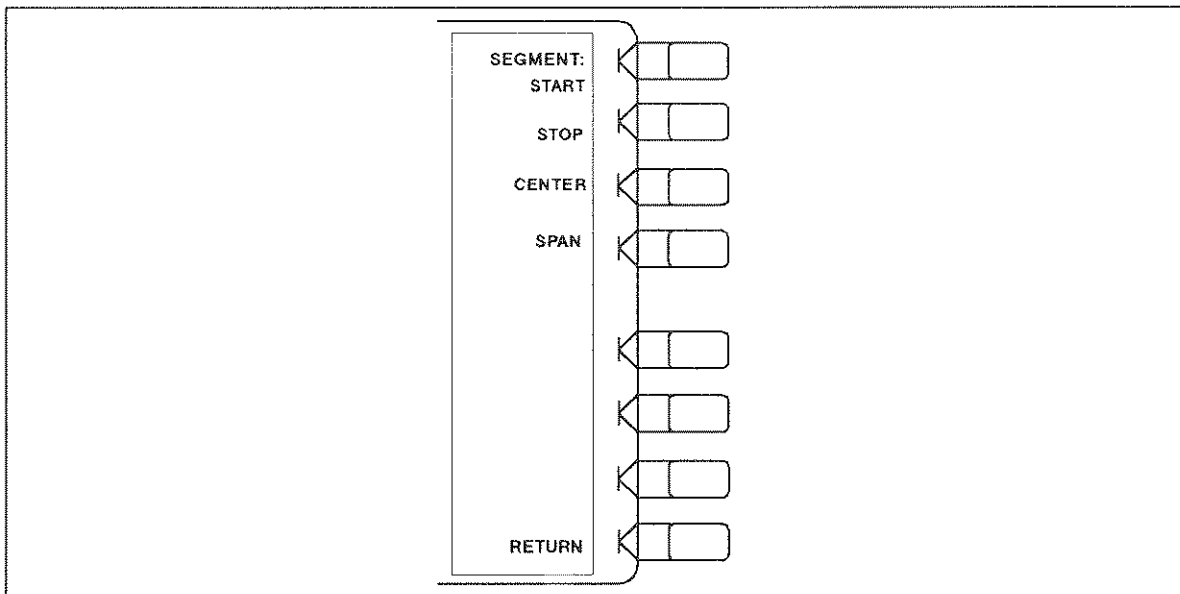

Figure 5-11. Edit Segment More Menu

SEGMENT START (STAR) sets the start frequency of a segment.

STOP (STOP) sets the stop frequency of a segment.

CENTER (CENT) sets the center frequency of a segment.

SPAN (SPAN) sets the frequency span of a segment about a specified center frequency.

RETURN goes back to the edit segment menu.

Clear List Menu

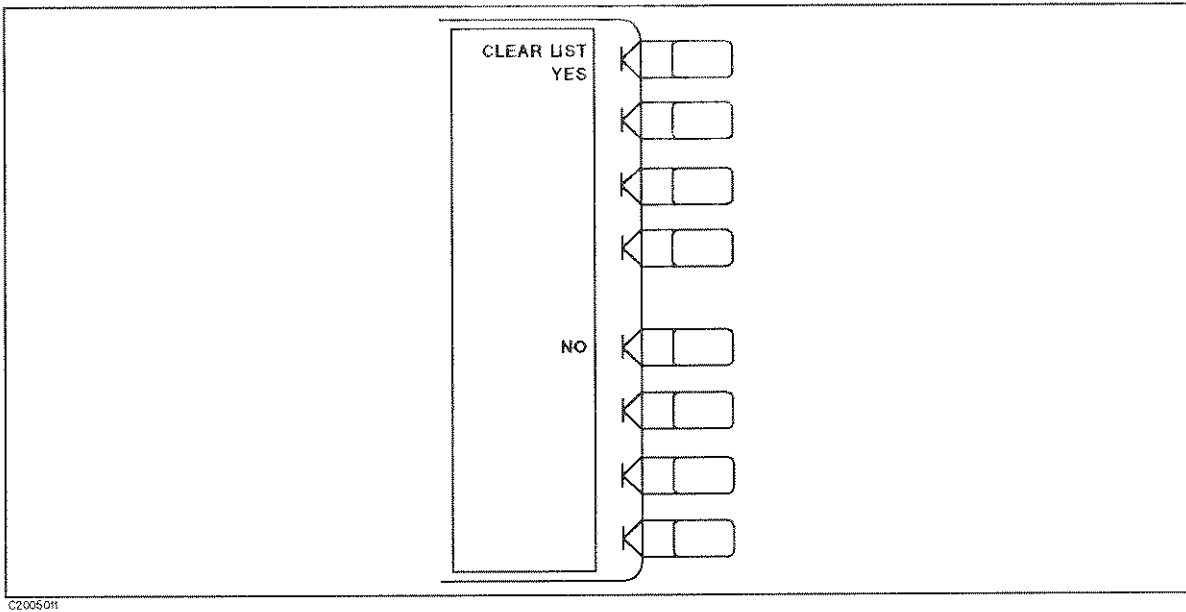

Figure 5-12. Clear List Menu

CLEAR LIST YES (CLEL) clears the entire list.

NO cancels and goes back to the edit list menu.

Contents

6. Response Function Block	
INTRODUCTION	6-1
MEAS KEY	6-2
S-Parameters	6-3
DC Voltage Measurement	6-4
S-Parameter Menu	6-4
Input Ports Menu	6-6
Conversion Menu	6-7
FORMAT KEY	6-9
Format Menu	6-9
Format More Menu	6-13
GROUP DELAY PRINCIPLES	6-16
SCALE REF KEY	6-19
Scale Reference Menu	6-19
Electrical Delay Menu	6-21
DISPLAY KEY	6-23
Display Menu	6-24
Problems with Dual Channel Mode	6-24
Display More Menu	6-26
Display Allocation Menu	6-27
Trace Math Menu	6-27
Title Menu	6-29
Conjugate Matching Menu	6-30
Select Circuit Menu	6-32
Adjust Display Menu	6-33
Modify Colors Menu	6-34
Color Adjust Menu	6-35
Adjusting Color	6-35
Setting Default Colors	6-36
Saving Modified Colors	6-36
Recalling Modified Colors	6-36
AVG KEY	6-37
Averaging	6-37
Smoothing	6-38
IF Bandwidth Reduction	6-38
Group Delay Aperture	6-39
Average Menu	6-39
IF Bandwidth Menu	6-41
ATTEN KEY	6-42
Attenuator Menu	6-42

Figures

6-1. Response Function Block	6-1
6-2. Softkey Menus Accessed from the MEAS Key	6-2
6-3. S-Parameters of a Two-Port Device	6-3
6-4. S-Parameter Menu	6-5
6-5. Input Ports Menu	6-6
6-6. Reflection Impedance and Admittance Conversions	6-7
6-7. Transmission Impedance and Admittance Conversions	6-7
6-8. Conversion Menu	6-8
6-9. Format and Format More Menus	6-9
6-10. Log Magnitude Format	6-10
6-11. Phase Format	6-10
6-12. Group Delay Format	6-11
6-13. Smith Chart Format	6-11
6-14. Polar Format	6-12
6-15. Linear Magnitude Format	6-12
6-16. Typical SWR Display	6-13
6-17. Real Format	6-13
6-18. Expanded phase Format	6-14
6-19. Inverse Smith Chart Formats	6-14
6-20. Log Magnitude and Phase Format	6-15
6-21. Log magnitude and Delay Format	6-15
6-22. Constant Group Delay	6-16
6-23. Higher Order Phase Shift	6-16
6-24. Rate of Phase Change Versus Frequency	6-17
6-25. Variations in Frequency Aperture	6-17
6-26. Softkey Menus Accessed from the SCALE REF Key	6-19
6-27. Scale Reference Menu	6-19
6-28. Electrical Delay Menu	6-21
6-29. Softkey Menus Accessed from the DISPLAY Key	6-23
6-30. Display Menu	6-24
6-31. Full-screen and Split Display	6-25
6-32. Display More Menu	6-26
6-33. Display Allocation Menu	6-27
6-34. Trace Math Menu	6-28
6-35. Title Menu	6-29
6-36. Conjugate Matching Menu	6-30
6-37. Matching Circuits	6-31
6-38. Select Circuit Menu	6-32
6-39. Adjust Display Menu	6-33
6-40. Modify Colors Menu	6-34
6-41. Color Adjust Menu	6-35
6-42. Softkey Menus Accessed from the AVG Key	6-37

6-43. Effect of Averaging on a Trace	6-37
6-44. Effect of Smoothing on a Trace	6-38
6-45. IF Bandwidth Reduction	6-39
6-46. Average Menu	6-39
6-47. IF Bandwidth Menu	6-41
6-48. Attenuator Menu	6-42

Tables

6-1. IF Bandwidth in AUTO mode 6-41

Response Function Block

INTRODUCTION

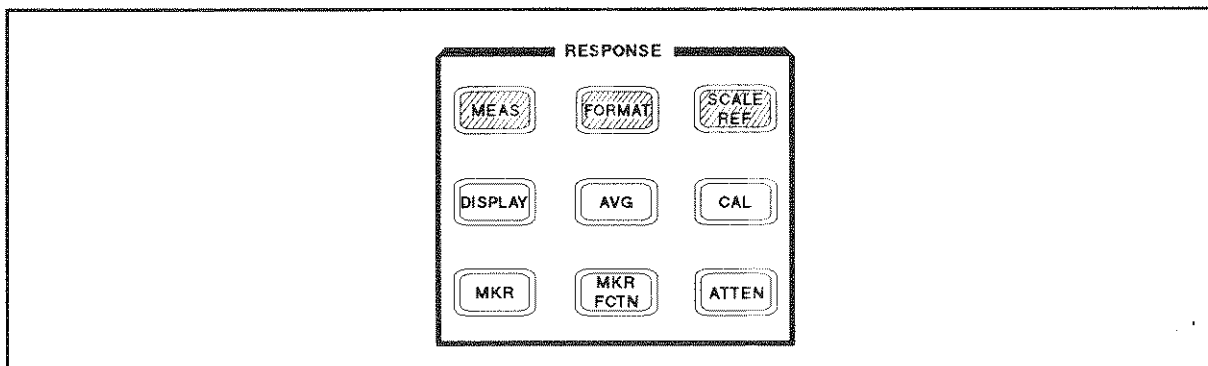

Figure 6-1. Response Function Block

The keys in the *RESPONSE* block control the measurement and display functions of the active channel. They provide access to many different softkey menus that offer selections for the measuring parameters, the display mode and data format, the control of the display markers, a variety of calibration functions, and selections for the internal attenuator.

The HP-IB programming command is shown in parenthesis following the key or softkey.

The current values for the major response functions of the active channel are displayed in specific locations along the top of the display. In addition, certain functions accessed through the keys in this block are annotated in the status notations area at the left side of the display. The locations of these information labels are described in Chapter 2.

The *RESPONSE* block keys and their associated menus are described briefly below, and in more detail in this and the following chapters. General and specific measurement sequences are described in the *User's Guide*.

The **MEAS** key provides access to a series of softkey menus for selecting the parameters or inputs to be measured.

The **FORMAT** key leads to a menu which selects the display format for the data. Various rectangular and polar formats are available for display of magnitude, phase, impedance, group delay, real data, imaginary data, and SWR.

The **SCALE REF** key displays a menu which modifies the vertical axis scale and the reference line value as well as electrical length and phase offset.

The **DISPLAY** key leads to a series of menus for instrument and active channel display functions. This menu includes dual channel display (overlaid or split), definition of the displayed active channel trace in terms of the mathematical relationship between data and

trace memory, conjugate matching function, display intensity, color selection, active channel display title, and frequency blanking.

The **AVG** key accesses three different noise reduction techniques: sweep-to-sweep averaging, trace smoothing, group delay aperture, and variable IF bandwidth.

The **ATTEN** key provides the attenuation menu from which the attenuators at the input A, B, and R are set.

The **CAL** key, **MKR** and **MKR FCTN** keys are explained later. For information on **CAL**, refer to Chapter 7. For information on **MKR**, and **MKR FCTN**, refer to Chapter 8.

MEAS KEY

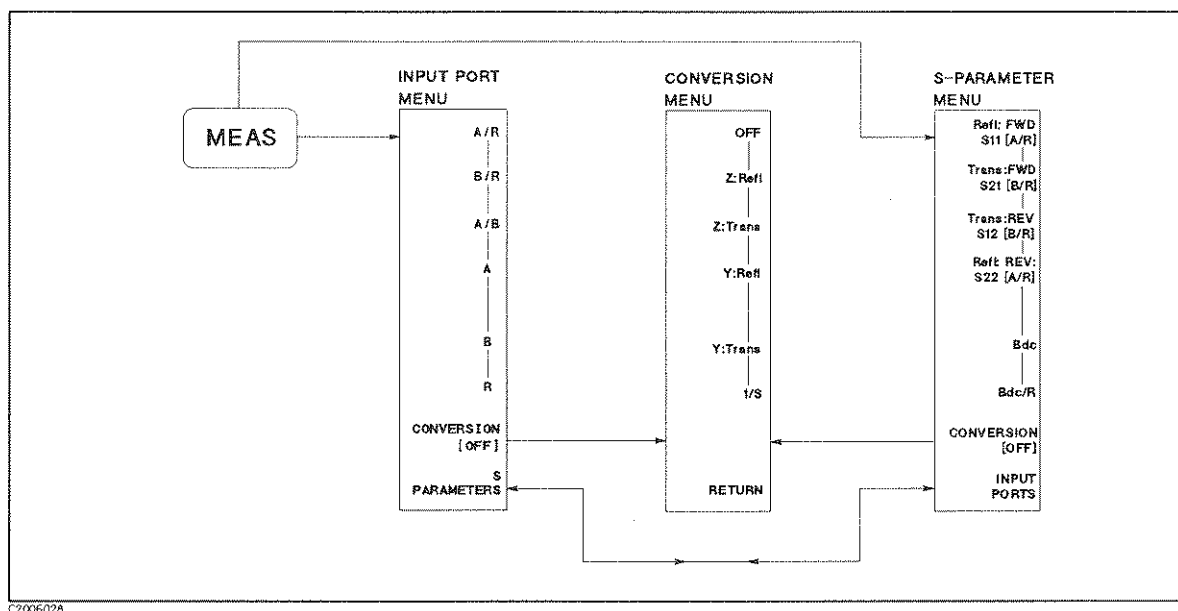

Figure 6-2. Softkey Menus Accessed from the **MEAS** Key

The HP-IB programming command is shown in parenthesis following the key or softkey.

The **MEAS** key leads to a series of softkey menus which determine the parameters or inputs to be measured. If an S-parameter test set is connected, all four S-parameters can be measured with a single connection. Or S-parameters can be measured using a transmission/reflection test set by reversing the device under test between measurements. S-parameters are explained briefly below.

Alternatively, the power ratio of any two inputs or the absolute power at a single input can be measured and displayed, using either test set.

S-parameters can be converted to impedance (Z), admittance (Y), or inverse S-parameters through internal math capabilities of the analyzer.

S-Parameters

S-parameters (scattering parameters) are a convention which characterizes the way a device modifies signal flow. A brief explanation is provided here of the S-parameters of a two-port device. For additional details refer to Hewlett-Packard Application Notes *A/N 95-1* and *A/N 154*.

S-parameters are always a ratio of two complex (magnitude and phase) quantities. S-parameter notation identifies these quantities using the numbering convention:

$$S_{\text{out in}}$$

where the first number (**out**) refers to the port where the signal is emerging and the second number (**in**) is the port where the signal is incident. For example, the S-parameter S_{21} identifies the measurement as the complex ratio of the signal emerging at port 2 to the signal incident at port 1.

Figure 6-3 is a representation of the S-parameters of a two-port device, together with an equivalent flowgraph. In the illustration, "a" represents the signal entering the device and "b" represents the signal emerging. Note that a and b are not related to the A and B input ports on the analyzer.

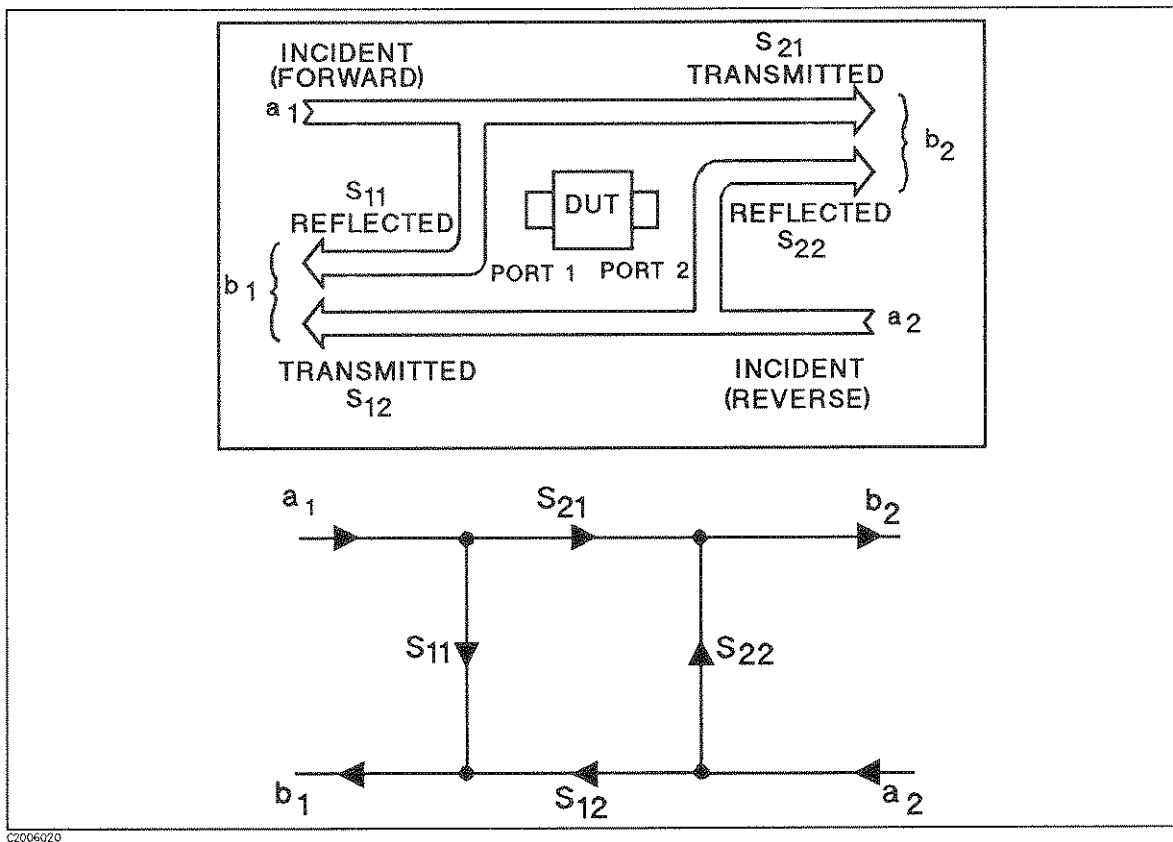

Figure 6-3. S-Parameters of a Two-Port Device

S-parameters are exactly equivalent to the more common description terms below, requiring only that the measurements are taken with all DUT ports properly terminated.

S-Parameter	Definition	Test Set Description	Direction
S ₁₁	$\frac{b_1}{a_1} _{a_2=0}$	Input reflection Coefficient	FWD
S ₂₁	$\frac{b_2}{a_1} _{a_2=0}$	Forward gain	FWD
S ₁₂	$\frac{b_1}{a_2} _{a_1=0}$	Reverse gain	REV
S ₂₂	$\frac{b_2}{a_2} _{a_1=0}$	Output reflection coefficient	REV

DC Voltage Measurement

The analyzer is capable of DC voltage measurement, which is useful for testing DUTs whose output is a DC voltage in response to an RF signal input, for example detectors, peak-detector circuits, F-V (frequency to voltage) converters.

In addition, mixer transmission characteristics can be measured. In general, network analyzers cannot measure those characteristics, because a mixer is a device whose input and output signal frequencies differ. Using this DC voltage measurement capability, with a detector or demodulator which converts the mixer output signal to a DC voltage, makes measurement of these characteristics possible.

S-Parameter Menu

The S-parameter menu is presented automatically when the **MEAS** key is pressed, if a test set is connected to the analyzer or if two-port error correction is ON. This menu defines the input ports and test set direction for S-parameter measurements. The analyzer controls the S-parameter test set, and automatically switches the direction of the measurement according to the selections made in this menu. All four S-parameters can be measured with a single connection. The S-parameter being measured is labeled at the top left corner of the display.

S-parameter measurements can also be made using HP 87512A/B transmission/reflection test kits, by reversing the device under test after making the forward reflection and transmission measurements. In this case, the softkey labels are changed to indicate the actual input ratios being measured (A/R for reflection or B/R for transmission measurements). Thus **Refl: REV S22 (B/R)** becomes **Refl: REV S22 (A/R)**, and **Trans: REV S12 (A/R)** becomes **Trans: REV S12 (B/R)**. However, the annotation in the top left corner indicates the S-parameter being measured.

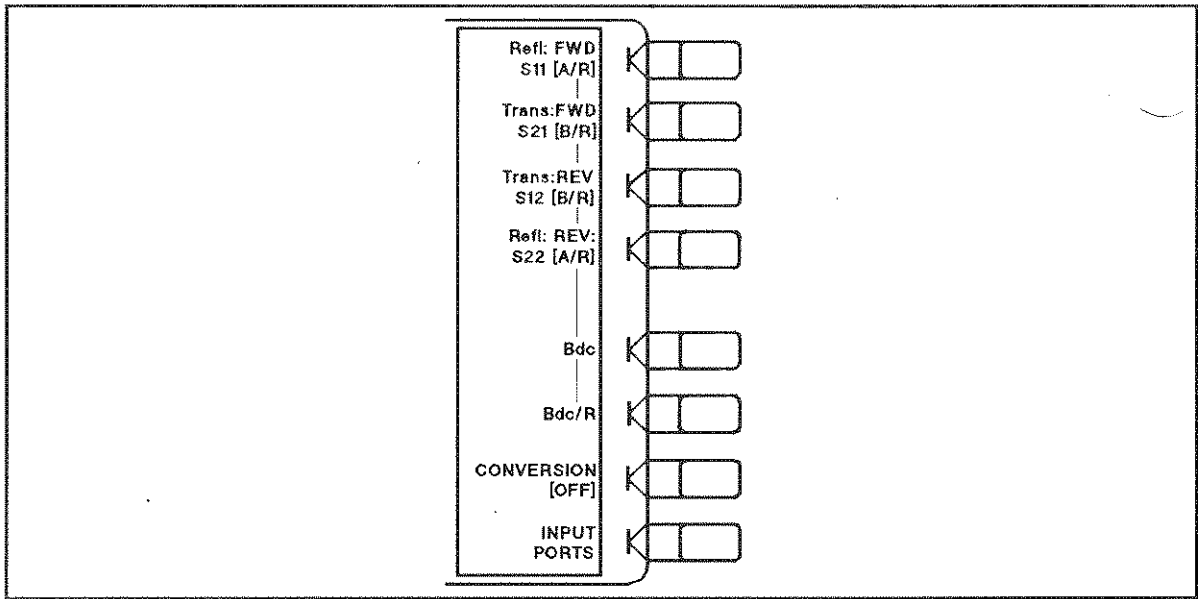

Figure 6-4. S-Parameter Menu

Refl: FWD S11 (A/R) (S11) configures the S-parameter test set for measurement of S_{11} , the complex reflection coefficient (magnitude and phase) of the test device input.

Trans: FWD S21 (B/R) (S21) configures the S-parameter test set for measurement of S_{21} , the complex forward transmission coefficient (magnitude and phase) of the device under test.

Trans: REV S12 (A/R) (S12) configures the S-parameter test set for measurement of S_{12} , the complex reverse transmission coefficient (magnitude and phase) of the device under test.

Refl: REV S22 (B/R) (S22) defines the measurement as S_{22} , the complex reflection coefficient (magnitude and phase) of the output of the device under test.

Note



If an HP 87512A/B transmission/reflection test kits are being used to make S-parameter measurements, the device under test must be reversed before S_{12} and S_{22} are measured.

Bdc (BDC) displays a DC voltage at input B, on the vertical axis.

Bdc/R (BDCR) calculates and displays the ratio of a DC voltage at input B to the reference signal at input R.

CONVERSION (CONV) brings up the conversion menu which converts the measured data to impedance (Z) or admittance (Y). When a conversion parameter has been defined, it is shown in brackets under the softkey label. If no conversion has been defined, the softkey label reads **CONVERSION [OFF]**.

INPUT PORTS goes to the input ports menu, which is used to define a ratio or single-input measurement rather than an S-parameter measurement.

Input Ports Menu

The input ports menu is presented when the **MEAS** key is pressed if there is no S-parameter test set connected and two-port error correction is not on. This menu defines the input ports for power ratio measurements, or a single input for magnitude only measurements of absolute power.

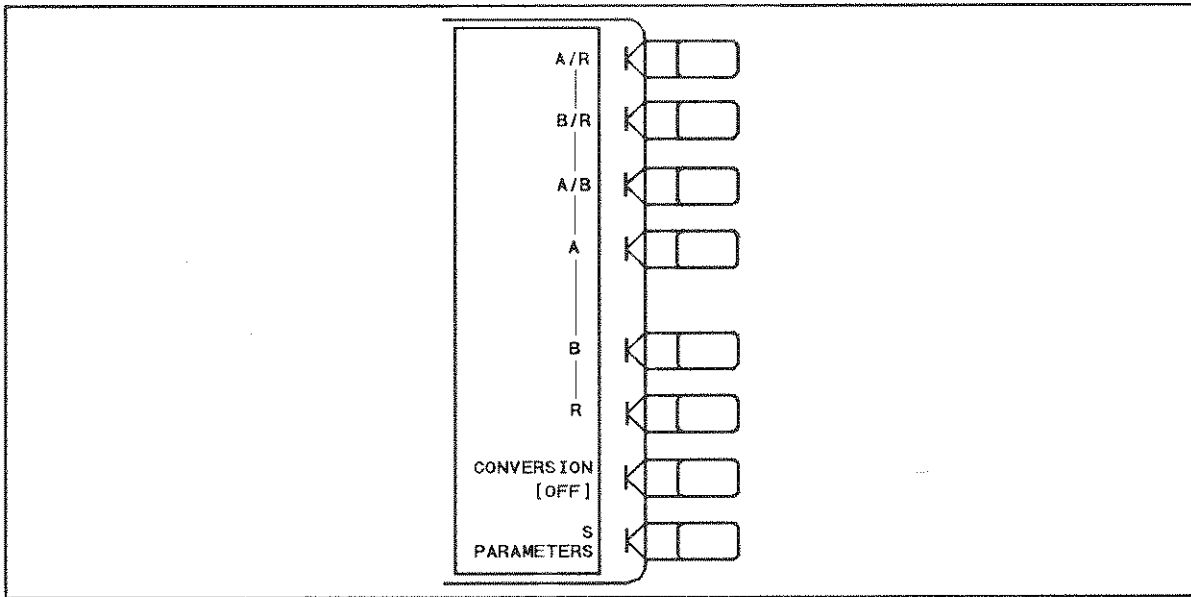

Figure 6-5. Input Ports Menu

A/R (AR) calculates and displays the complex ratio of the signal at input A to the reference signal at input R.

B/R (BR) calculates and displays the complex ratio of input B to input R.

A/B (AB) calculates and displays the complex ratio of input A to input B.

A (MEASA) measures the absolute power amplitude at input A.

B (MEASB) measures the absolute power amplitude at input B.

R (MEASR) measures the absolute power amplitude at input R.

CONVERSION presents the conversion menu, which converts the measured data to impedance (Z) or admittance (Y). When a conversion parameter has been defined, it is shown in brackets under the softkey label. If no conversion has been defined, the softkey label reads **CONVERSION OFF**. **S PARAMETERS** presents the S-parameter menu, which defines the input ports and test set direction for S-parameter measurements.

Conversion Menu

This menu converts the measured reflection or transmission data to the equivalent complex impedance (Z) or admittance (Y) values. This is not the same as a two-port Y or Z parameter conversion, as only the measured parameter is used in the equations. Two simple one-port conversions are available, depending on the measurement configuration.

An S_{11} or S_{22} trace measured as reflection can be converted to an equivalent parallel impedance or admittance using the model and equations shown in Figure 6-6.

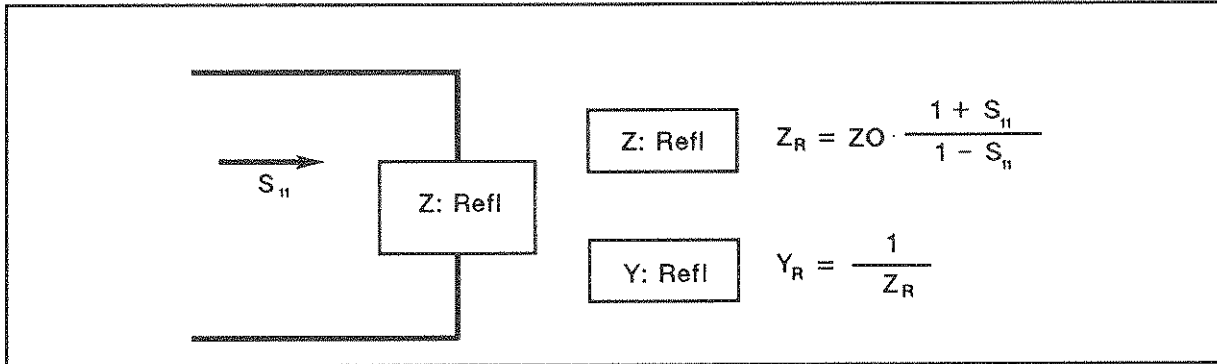

C2006021

Figure 6-6. Reflection Impedance and Admittance Conversions

In a transmission measurement, the data can be converted to its equivalent series impedance or admittance using the model and equations shown in Figure 6-7.

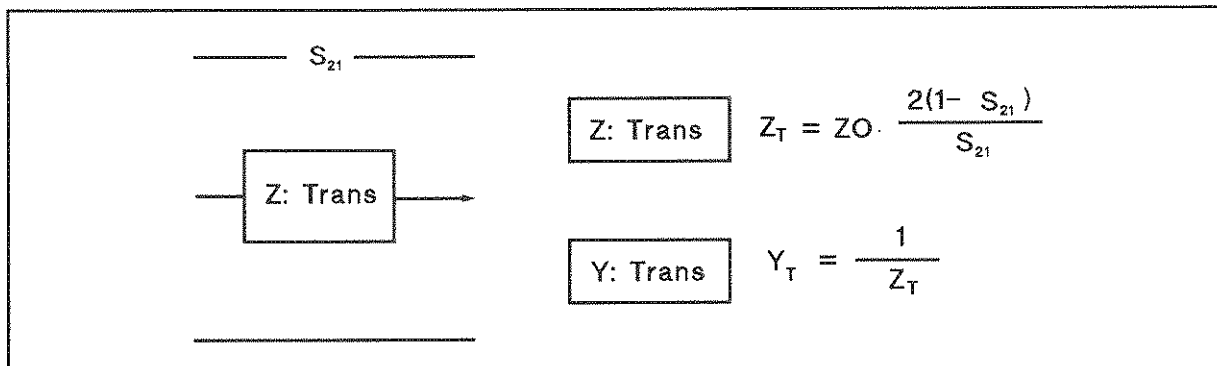

C2006022

Figure 6-7. Transmission Impedance and Admittance Conversions

Avoid using Smith chart, SWR, and delay formats for displaying Z and Y conversions, as these formats are not easily interpreted.

In all conversions except for “1/S”, marker values are impedance values in Ω units for Z conversions, or admittance values in S units for Y conversions in any format.

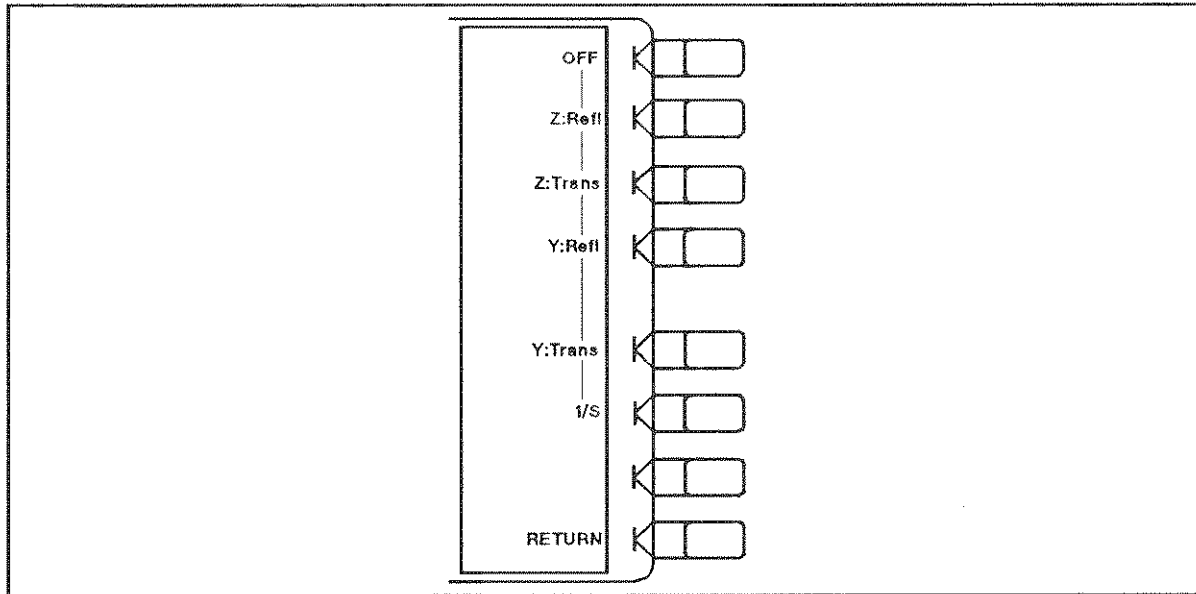

Figure 6-8. Conversion Menu

OFF (CONVOFF) turns off all parameter conversion operations.

Z: Refl (CONVZREF) converts reflection data to its equivalent impedance values.

Z: Trans (CONVZTRA) converts transmission data to its equivalent impedance values.

Y: Refl (CONVYREF) converts reflection data to its equivalent admittance values.

Y: Trans (CONVYTRA) converts transmission data to its equivalent admittance values.

1/S (CONV1DS) expresses the data in inverse S-parameter values, for use in amplifier and oscillator design.

RETURN returns to the last menu, either the S-parameter or the input ports menu.

FORMAT KEY

The HP-IB programming command is shown in parenthesis following the key or softkey.

Format Menu

The **FORMAT** key presents a menu used to select the appropriate display format for the measured data. Various rectangular and polar formats are available for display of magnitude, phase, real data, imaginary data, impedance, group delay, and SWR. The units of measurement are changed automatically to correspond with the displayed format. Special marker menus are available for the polar and Smith formats, each providing several different marker types for readout of values (Refer to Chapter 8).

The illustrations below show a reflection measurement of a band pass filter displayed in each of the available formats. Measurement procedure is described in *the User's Guide*.

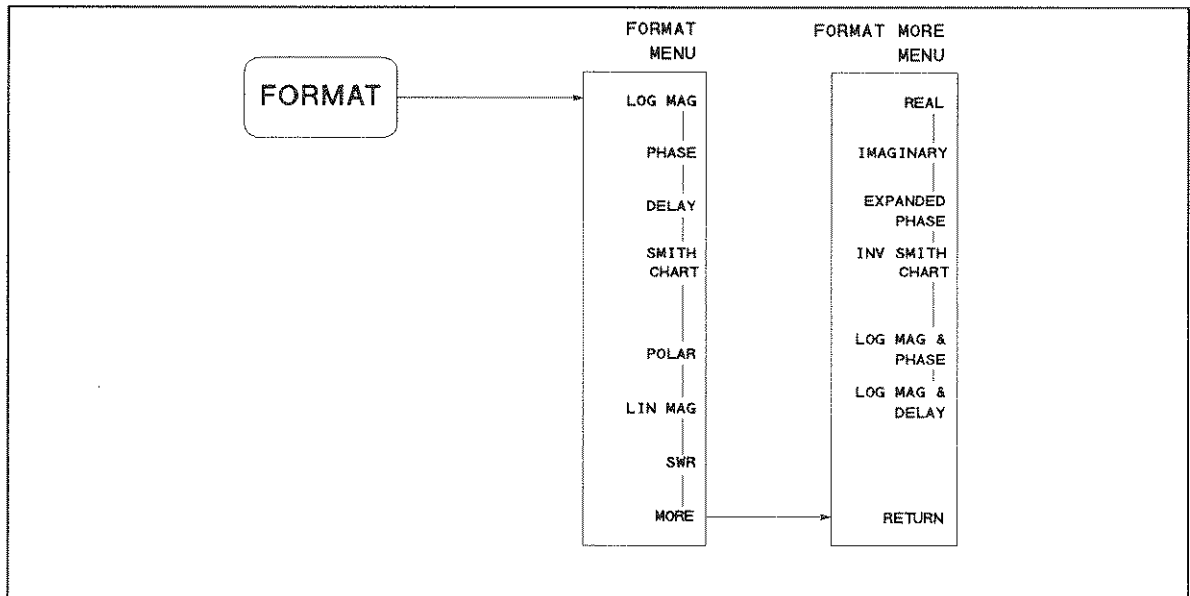

C2006029

Figure 6-9. Format and Format More Menus

LOG MAG (LOGM) displays the log magnitude format. This is the standard Cartesian format used to display magnitude-only measurements of insertion loss, return loss, or absolute power in dB versus frequency. Figure 6-10 illustrates the bandpass filter reflection data in a log magnitude format.

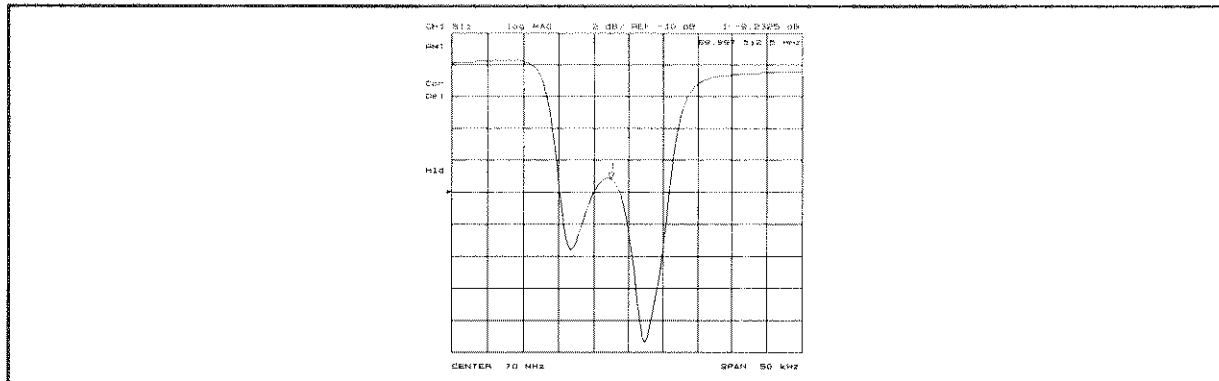

Figure 6-10. Log Magnitude Format

PHASE (PHAS) displays a Cartesian format of the phase portion of the data, measured in degrees. This format displays the phase shift versus frequency. Figure 6-11 illustrates the phase response of the same filter in a phase-only format.

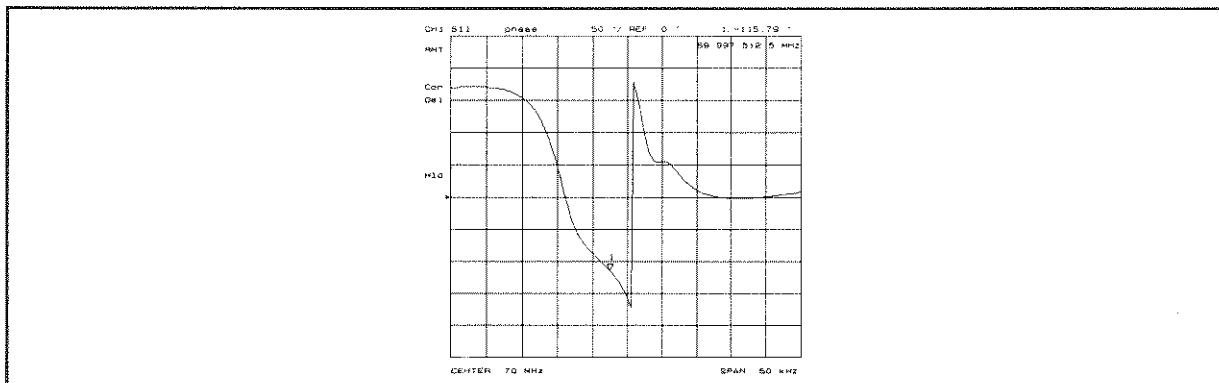

Figure 6-11. Phase Format

DELAY (DELA) selects the group delay format. Activated markers give values in seconds. Figure 6-12 shows the bandpass filter response formatted as group delay. When power sweep is selected, this selects the delay format using delta power instead of frequency. Group delay principles are described in the next few pages.

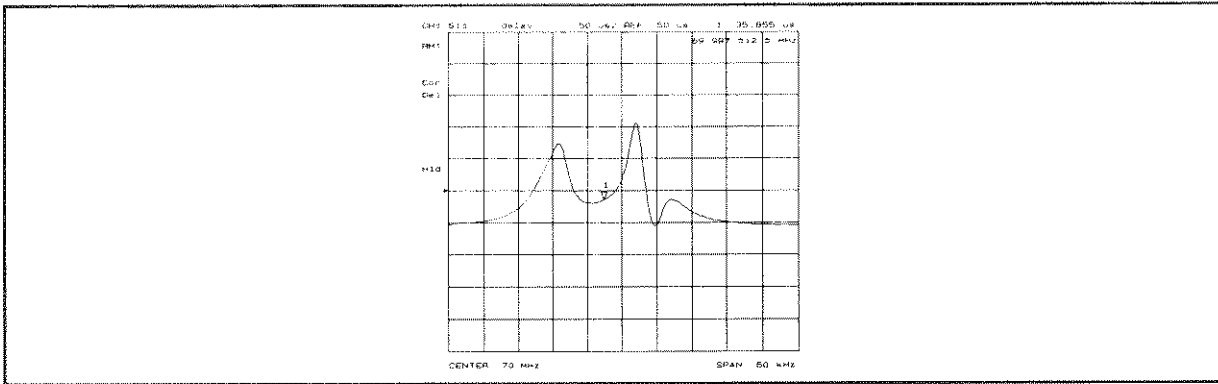

Figure 6-12. Group Delay Format

SMITH CHART (SMIC) displays a Smith chart format (Figure 6-13). This is used in reflection measurements to provide a readout of the data in terms of impedance. The intersecting lines on the Smith chart represent constant resistance and constant reactance values, normalized to the characteristic impedance, Z_0 , of the system. Reactance values in the upper half of the Smith chart circle are positive (inductive) reactance, and in the lower half of the circle are negative (capacitive) reactance. The default marker readout is in units of resistance and reactance ($R+jX$). Additional marker types are available in the Smith marker menu (refer to Chapter 8).

The Smith chart is most easily understood with a full scale value of 1.0. If the scale per division is less than 0.2, the format switches automatically to polar.

If the characteristic impedance of the system is not 50Ω , modify the impedance value recognized by the analyzer using the SET Z_0 softkey in the calibrate more menu. (Refer to Chapter 7.)

Procedures for measuring impedance are provided in *the User's Guide*.

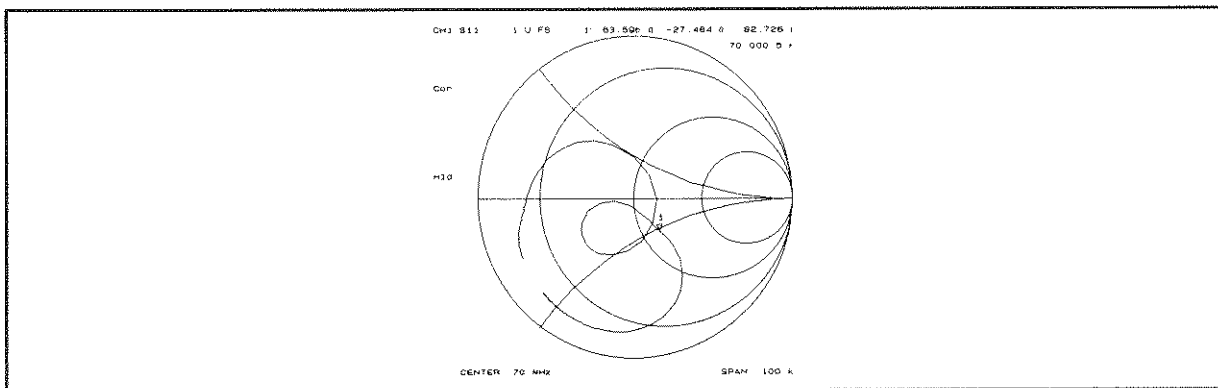

Figure 6-13. Smith Chart Format

POLAR (POLA) displays a polar format (Figure 6-14). Each point on the polar format corresponds to a particular value of both magnitude and phase. Quantities are read vectorally: the magnitude at any point is determined by its displacement from the center (which has zero value), and the phase by the angle counterclockwise from the positive x-axis. Magnitude is scaled in a linear fashion, with the value of the outer circle usually set to a ratio value of 1. Since there is no frequency axis, frequency information is read from the markers.

The default marker readout for the polar format is in linear magnitude and phase. A log magnitude marker and a real/imaginary marker are available in the polar marker menu (refer to Chapter 8).

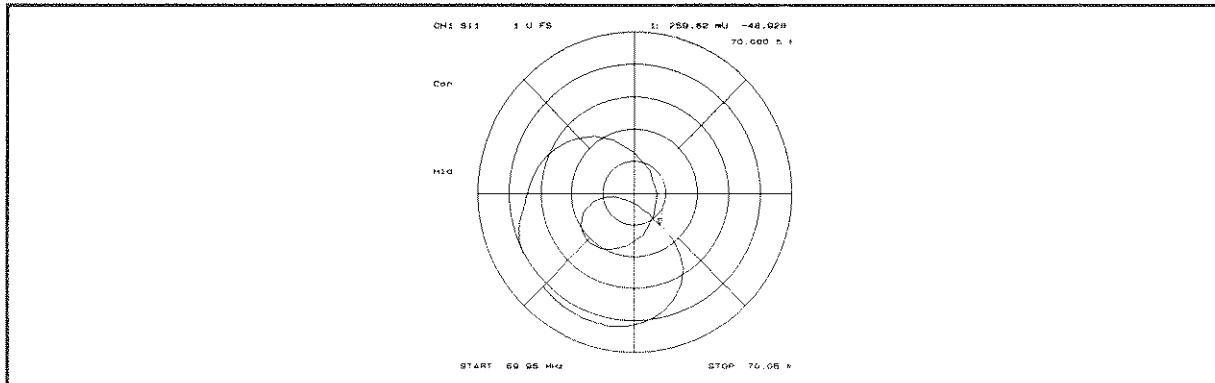

Figure 6-14. Polar Format

LIN MAG (LINM) displays the linear magnitude format (Figure 6-15). This is a Cartesian format used for unitless measurements such as reflection coefficient magnitude ρ or transmission coefficient magnitude τ , and for linear measurement units. It is used for display of conversion parameters.

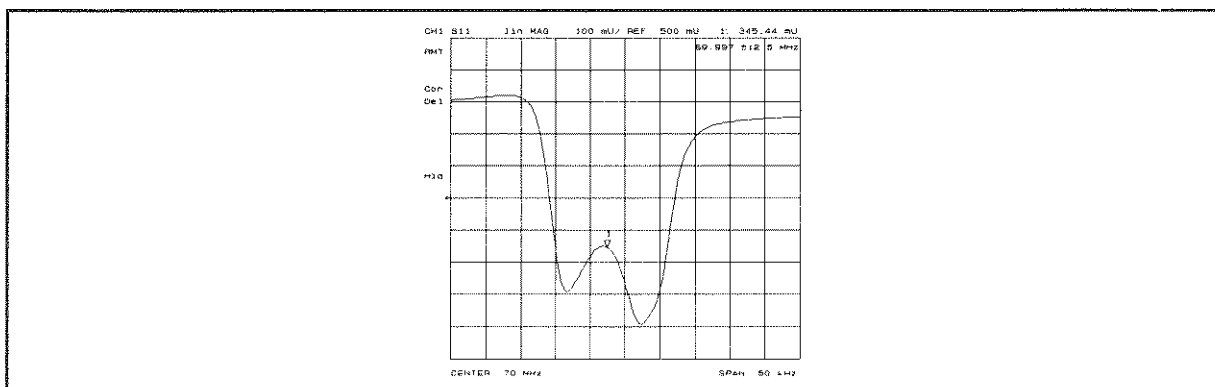

Figure 6-15. Linear Magnitude Format

SWR (SWR) reformats a reflection measurement into its equivalent SWR (standing wave ratio) value (Figure 6-16). SWR is equivalent to $(1+|\rho|)/(1-|\rho|)$, where ρ is the reflection coefficient.

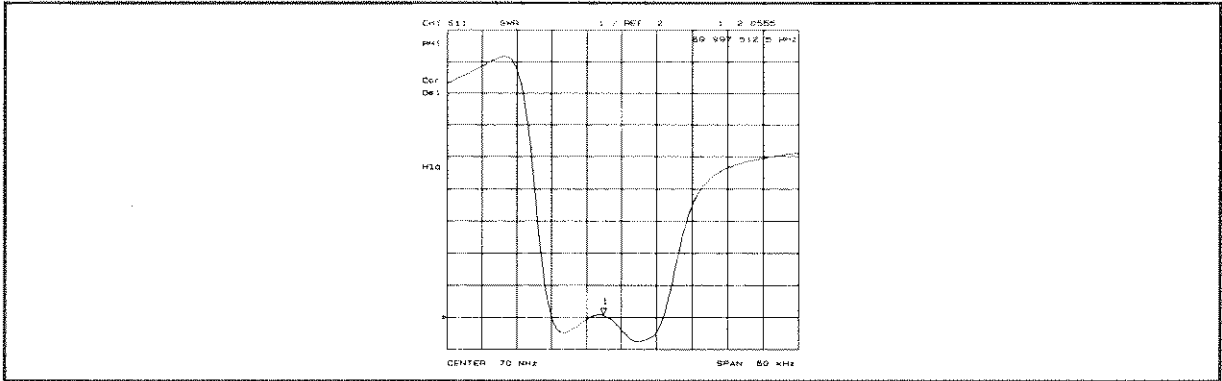

Figure 6-16. Typical SWR Display

MORE provides the format more menu described in the next section.

Format More Menu

This menu provides two additional formatting selections.

REAL (REAL) displays only the real (resistive) portion of the measured data on a Cartesian format (Figure 6-17). This is similar to the linear magnitude format, but can show both positive and negative values. It is primarily used to display a Bdc input voltage signal.

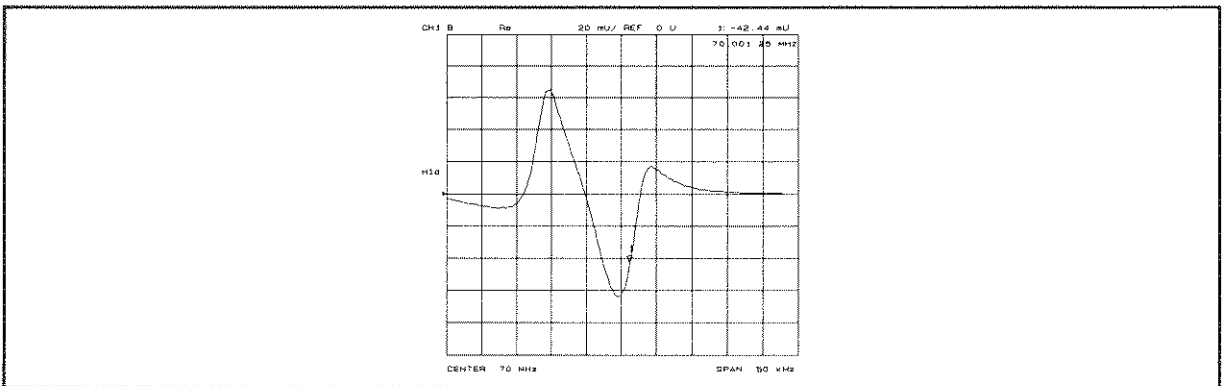

Figure 6-17. Real Format

IMAGINARY (IMAG) displays only the imaginary (reactive) portion of the measured data on a Cartesian format. This format is similar to the real format except that reactance data is displayed on the trace instead of impedance data.

EXPANDED PHASE (EXPP) displays the phase plot over 360° (Figure 6-18). When this is turned on, the analyzer avoids the phase plot wrap around every 360°.

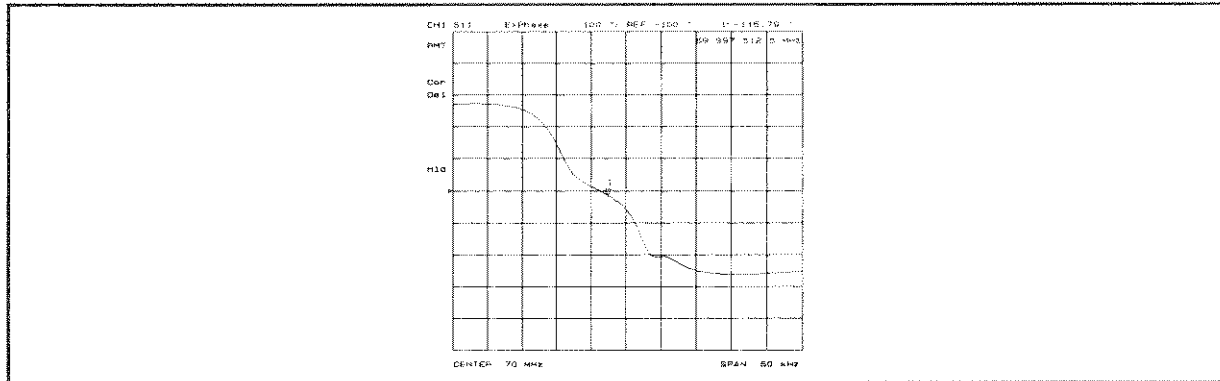

Figure 6-18. Expanded phase Format

INV SMITH CHART (INVSCHAR) displays a inverse Smith chart (admittance Smith chart) format (Figure 6-19). This used in reflection measurement to provide a readout of the data in terms of admittance.

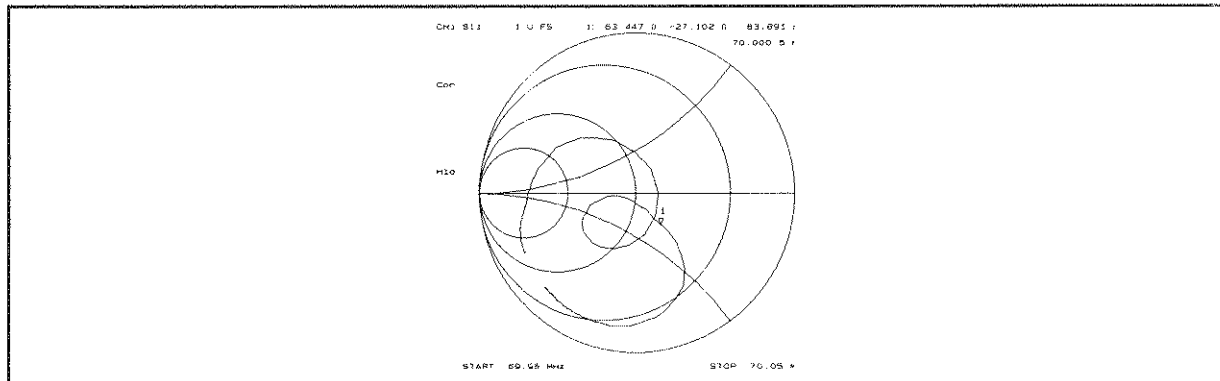

Figure 6-19. Inverse Smith Chart Formats

LOG MAG & PHASE (LOGMP) displays log magnitude trace and phase trace for the active channel simultaneously. When this softkey is turned on, some other softkeys will denote the log magnitude trace and the phase as “DATA” and “MEMORY”, respectively.

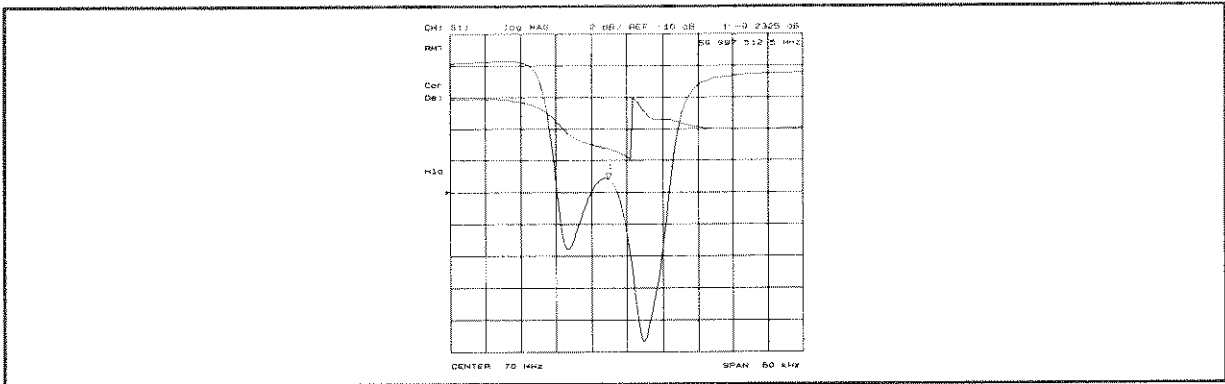

Figure 6-20. Log Magnitude and Phase Format

LOG MAG & DELAY (LOGMD) displays log magnitude trace and delay trace for the active channel simultaneously. When this softkey is turned on, some other softkeys will denote the log magnitude trace and the delay as “DATA” and “MEMORY”, respectively.

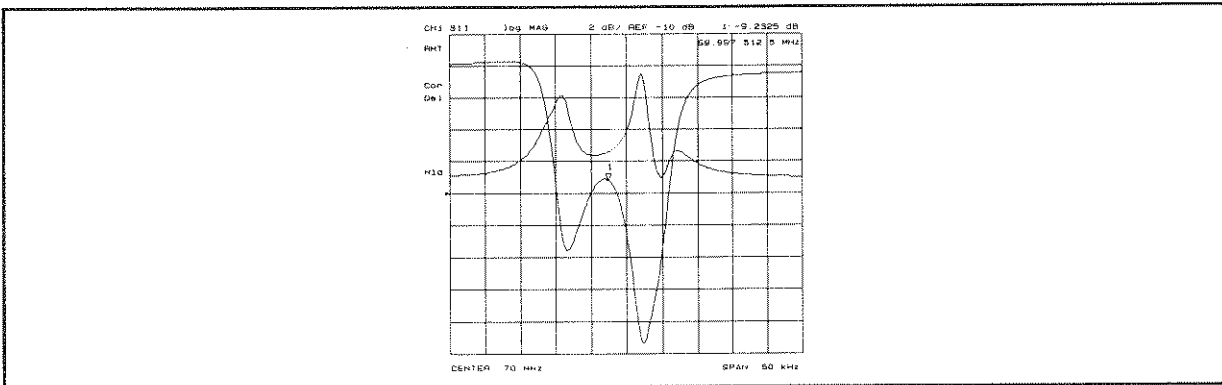

Figure 6-21. Log magnitude and Delay Format

RETURN goes back to the format menu.

GROUP DELAY PRINCIPLES

For many networks, the amount of insertion phase is not as important as the linearity of the phase shift over a range of frequencies.

The analyzer can measure this linearity and express it in two different ways: directly, as deviation from linear phase, or as group delay, a derived value. Refer to **SCALE REF** key description in this chapter for information on deviation from linear phase.

Group delay is the measurement of signal transmission time through a test device. It is defined as the derivative of the phase characteristic with respect to frequency. Since the derivative is basically the instantaneous slope (or rate of change of phase with frequency), a perfectly linear phase shift results in a constant slope, and therefore a constant group delay (Figure 6-22).

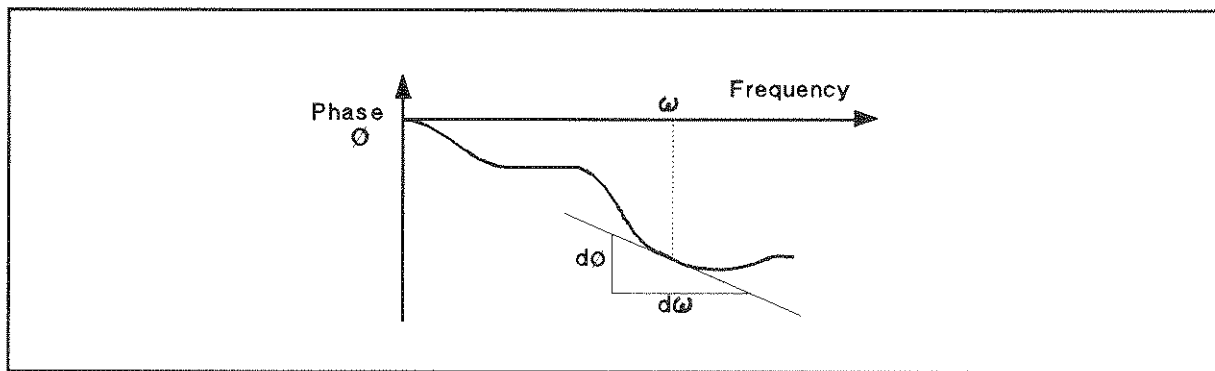

C2006023

Figure 6-22. Constant Group Delay

Note, however, that the phase characteristic typically consists of both linear and higher order (deviations from linear) components. The linear component can be attributed to the electrical length of the test device, and represents the average signal transit time. The higher order components are interpreted as variations in transit time for different frequencies, and represent a source of signal distortion (Figure 6-23).

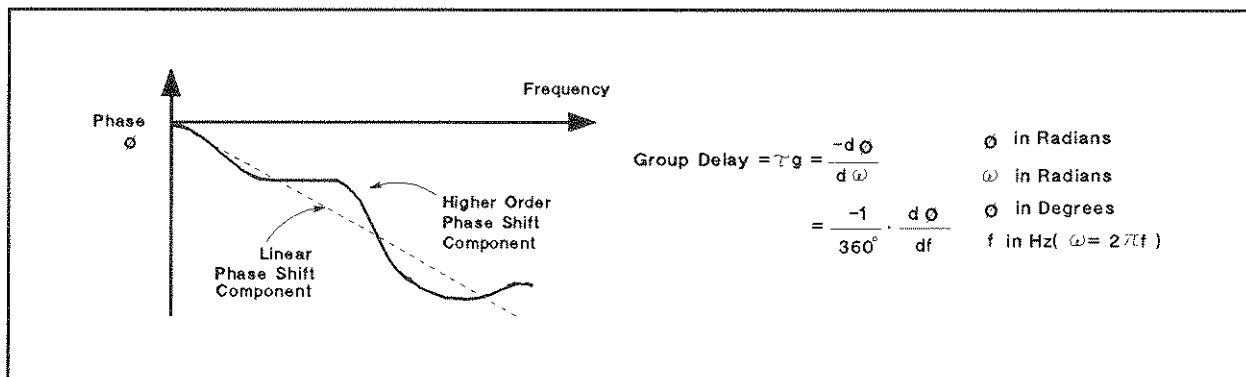

C2006024

Figure 6-23. Higher Order Phase Shift

The analyzer computes group delay from the phase slope. Phase data is used to find the phase deviation, $\Delta\varphi$, at the center point of a specified frequency aperture, Δf , to obtain an approximation for the rate of change of phase with frequency (Figure 6-24). This value, τ_g , represents the group delay in seconds assuming linear phase change over Δf .

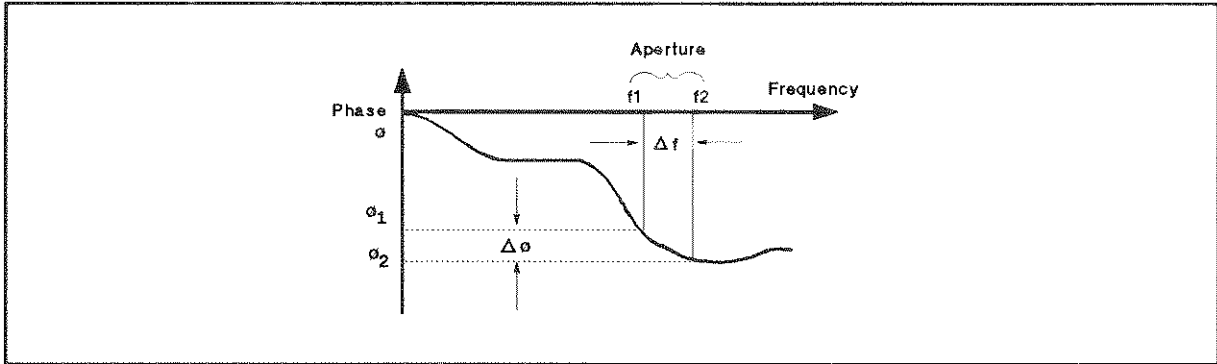

Figure 6-24. Rate of Phase Change Versus Frequency

When deviations from linear phase are present, changing the frequency step can result in different values for group delay. Note that in this case the computed slope varies as the aperture Δf is increased (Figure 6-25). A wider aperture results in loss of the fine grain variations in group delay. This loss of detail is the reason that in any comparison of group delay data it is important to know the aperture used to make the measurement.

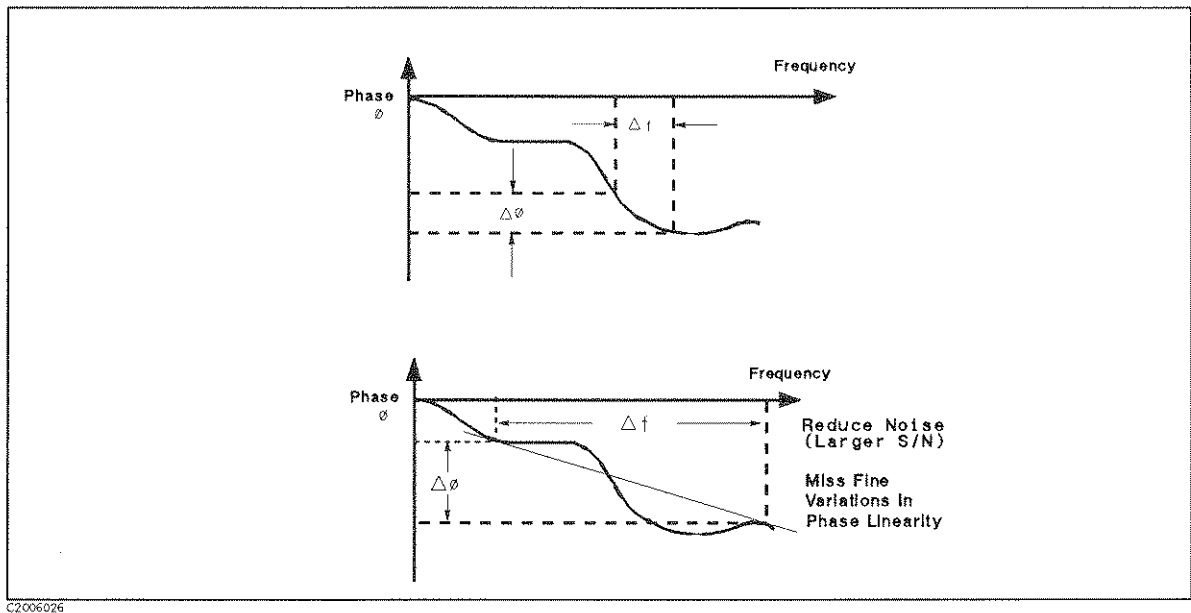

Figure 6-25. Variations in Frequency Aperture

In determining the group delay aperture, there is a tradeoff between resolution of fine detail and the effects of noise. Noise can be reduced by increasing the aperture, but this will tend to smooth out the fine detail. More detail will become visible as the aperture is decreased, but the noise will also increase, possibly to the point of obscuring the detail. A good practice

is to use a smaller aperture to assure that small variations are not missed, then increase the aperture to smooth the trace.

The group delay aperture value will be a percent of the stimulus span swept which is based on the number of points. For example, the default value of 1% means that a group delay at a certain point is calculated using adjacent measurement points on both sides, if the number of points is 201.

Group delay measurements can be made on linear frequency, log frequency, or list frequency sweep types (avoid the use of the power sweep, it will be meaningless). Group delay aperture varies depending on the frequency spacing and point density, therefore the aperture is not constant in log and list frequency sweep modes. In list frequency mode, extra frequency points can be defined to ensure the desired aperture.

To obtain a readout of aperture values at different points on the trace, move the marker to a desired point. Then press **AVG** **GROUP DELY APERTURE**. Group delay aperture becomes the active function, and as the aperture is varied its value in Hz is displayed below the active entry area.

A group delay measurement procedure is provided in *the User's Guide*.

SCALE REF KEY

The HP-IB programming command is shown in parenthesis following the key or softkey.

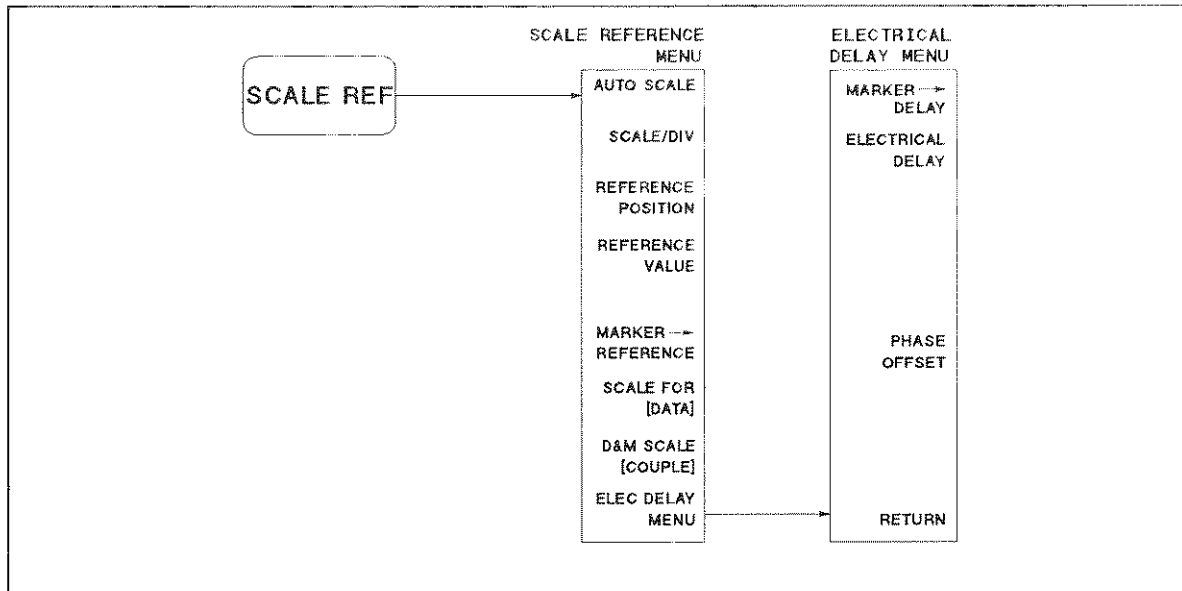

C2006054

Figure 6-26. Softkey Menus Accessed from the SCALE REF Key

Scale Reference Menu

The SCALE REF key makes scale per division the active function. A menu is displayed that modifies the vertical axis scale and the reference line value and position. In addition this menu provides phase offset capabilities for adding or subtracting a phase offset, that is constant with frequency, and electrical delay capability for adding or subtracting linear phase to maintain phase linearity.

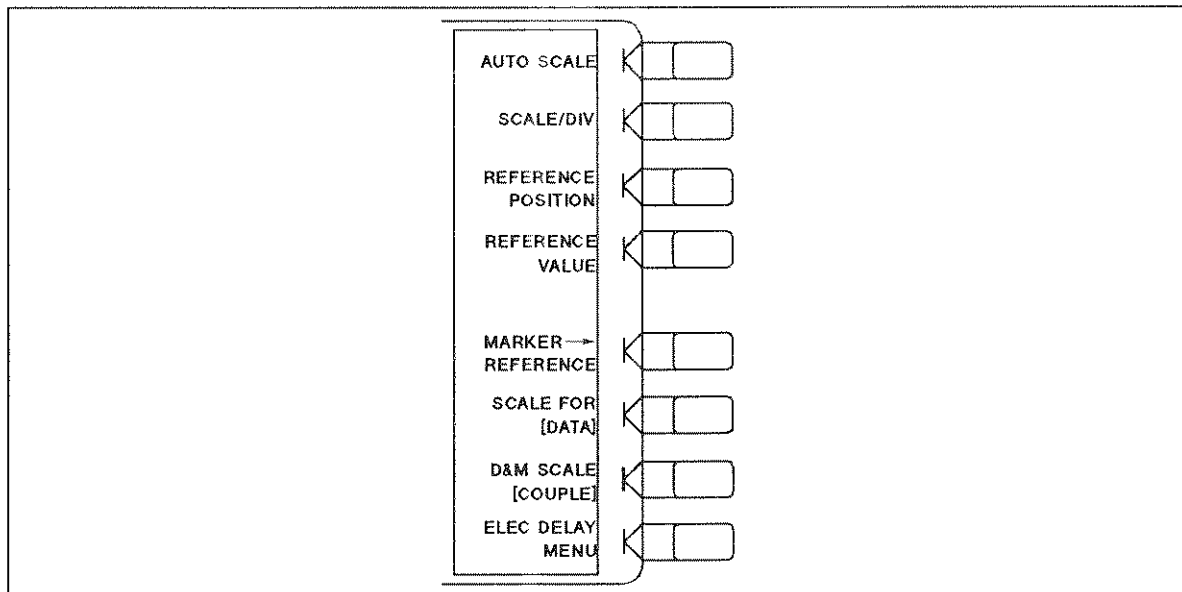

C2006006

Figure 6-27. Scale Reference Menu

AUTO SCALE (AUTO) brings the trace data, defined by the **SCALE FOR** key, in view on the display with one keystroke. Stimulus values are not affected, only scale and reference values. The analyzer determines the smallest possible scale factor that will put all displayed data onto the vertical graticule. The reference value is chosen to put the trace in center screen, then rounded to an integer multiple with 1-2-5 step of the scale factor.

SCALE/DIV (SCAL) changes the response value scale per division of the displayed trace. In polar and Smith chart formats, this refers to the full scale value at the outer circumference, and is identical to the reference value.

REFERENCE POSITION (REFP) sets the position of the reference line on the graticule of a Cartesian display, with 0 at the bottom line of the graticule and 10 at the top line. It has no effect on a polar or Smith display. The reference position is indicated with a small triangle just outside the graticule, on the left.

REFERENCE VALUE (REFV) changes the value of the reference line, moving the measurement trace correspondingly. In polar and Smith chart formats, the reference value is the same as the scale, and is the value of the outer circle.

MARKER → REFERENCE (MARKREF) makes the reference value equal to the active marker's absolute value (regardless of the delta marker value). The marker is effectively moved to the reference line position. This softkey also appears in the marker function menu accessed from the **(MKR FCTN)** key. In polar and Smith chart formats this function makes the full scale value at the outer circle equal to the active marker response value.

SCALE FOR (SCAFDATA for data, SCAFMEMO for memory) selects one of "DATA" and "MEMORY" traces to be scaled by prior functions in this menu, when the format is selected anyone except "LOG MAG & PHASE" and "LOG MAG & DELAY". When "LOG MAG & PHASE" or "LOG MAG & DELAY" format is selected, **SCALE FOR** selects one of "LOG MAG" and "PHASE"(for LOGMAG and PHASE) or "DELAY"(for LOGMAG and DELAY) to be scaled.

The "DATA" AND "MEMORY" traces will be available using the "Trace Math Menu" accessed from the **(DISPLAY)** key. The "LOG MAG & PHASE" and "LOG MAG & DELAY" format will be available using the "FORMAT MORE MENU" accessed from the **(FORMAT)** key.

D&M SCALE (SCAC for coupling, SCAU for uncoupling) couples or uncouples the "DATA" and "MEMORY" traces to be scaled by prior functions in this menu. This is valid only for those traces obtained by the "Trace Math Menu" accessed from the **DISPLAY** key. The "LOG MAG & PHASE" or "LOG MAG & DELAY" traces are not valid.

ELEC DELAY MENU provides "Electrical Delay Menu", which adds or subtracts a linear phase slope relative to frequency or a constant phase.

Electrical Delay Menu

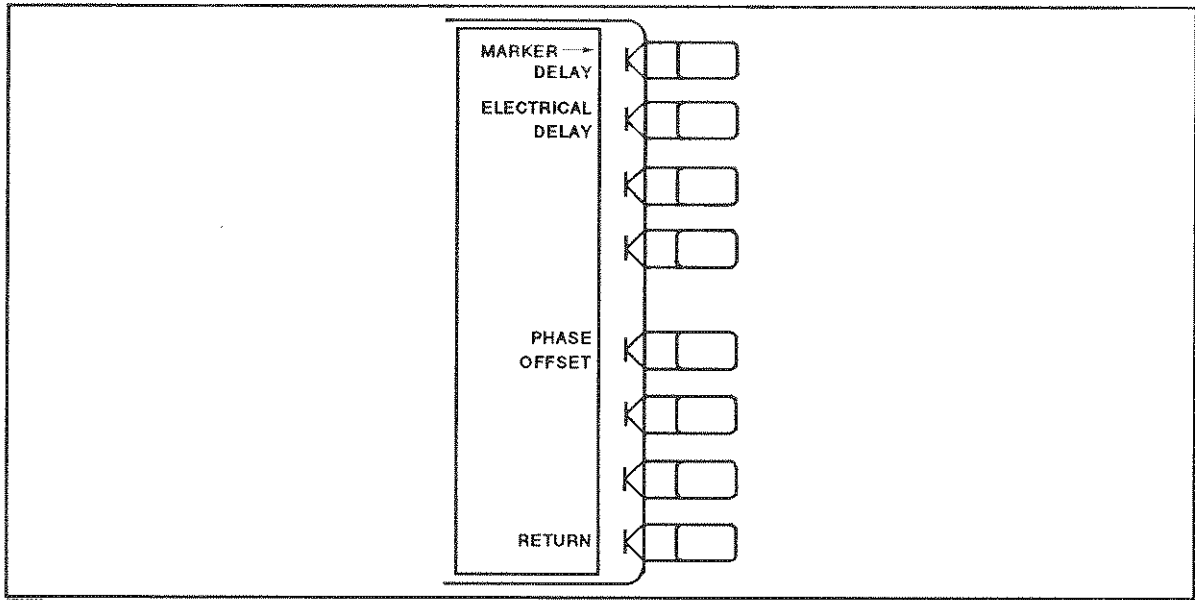

Figure 6-28. Electrical Delay Menu

MARKER — DELAY (MARKDELA) enters the group delay at the active marker point of a fixed frequency aperture, 20 % of the span, to the electrical delay to balance the phase of the DUT. This effectively flattens the phase trace around the active marker, and can measure electrical length or deviation from linear phase. Additional electrical delay adjustment are required on DUT without constant group delay over the measured frequency span. Since this feature adds phase to a variation in phase versus frequency, it is applicable only for ratioed input.

ELECTRICAL DELAY (ELED) adjusts the electrical delay to balance the phase shift of the DUT. It simulates a variable length lossless transmission line, which can be added to or removed from a receiver input to compensate for interconnecting cables, etc. This function is similar to the mechanical or analog “line stretchers” of other network analyzers. Delay is annotated in units of time with secondary labeling in distance for the current velocity factor.

With this feature, and with **MARKER — DELAY**, an equivalent length of air is added or subtracted according to the following formula:

$$\text{Length (meters)} = \frac{\phi}{\text{Frequency (MHz)} \times 1.20083}$$

Once the linear portion of the DUT’s phase has been removed, the equivalent length of air can be read out in the active entry area. If the average relative permittivity (ϵ_r) of the DUT is known over the frequency span, the length calculation can be adjusted to indicated the actual length of the DUT more closely. This can be done by entering the relative velocity factor for the DUT using the calibrate more menu. The relative velocity factor for a given dielectric can be calculated by:

$$\text{Velocity factor} = \frac{1}{\sqrt{\epsilon_r}}$$

assuming a relative permeability of 1.

A procedure for measuring electrical length or deviation from linear phase using the MARKER → DELAY or ELECTRICAL DELAY features is provided in the *User's Guide*.

PHASE OFFSET (PHAO) adds or subtracts a phase offset that is constant with frequency (rather than linear). The allowable range is -360° to $+360^\circ$. This is independent of MARKER → DELAY and ELECTRICAL DELAY.

RETURN goes back to the scale reference menu.

DISPLAY KEY

The HP-IB programming command is shown in parenthesis following the key or softkey.

The **DISPLAY** key provides access to the trace math functions, and other display functions including dual channel display, active channel display title, frequency blanking, display intensity, background intensity, color selection, and conjugate matching function.

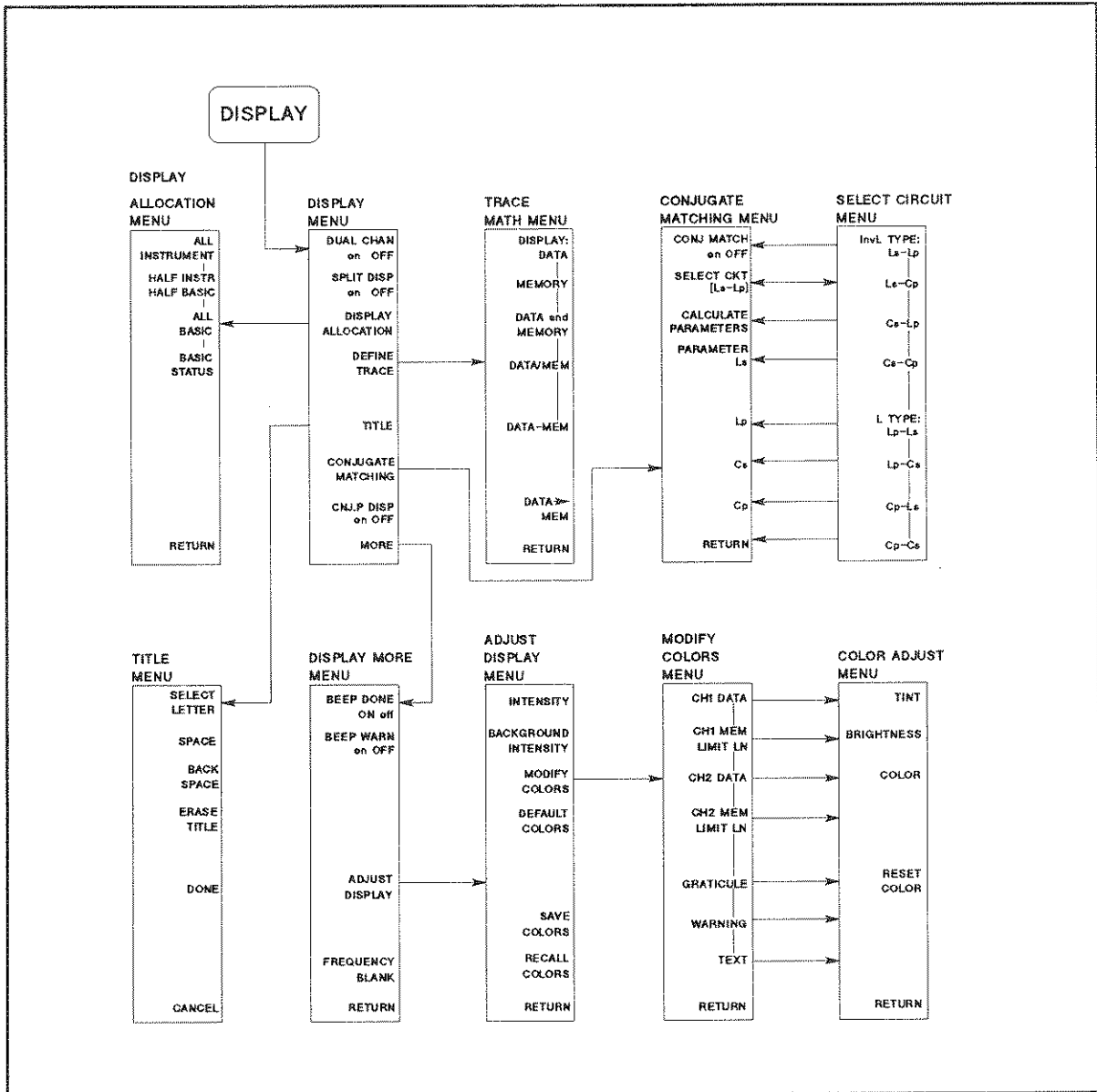

C2006031

Figure 6-29. Softkey Menus Accessed from the **DISPLAY** Key

Display Menu

This menu provides the capability of displaying both channels simultaneously, either overlaid or split.

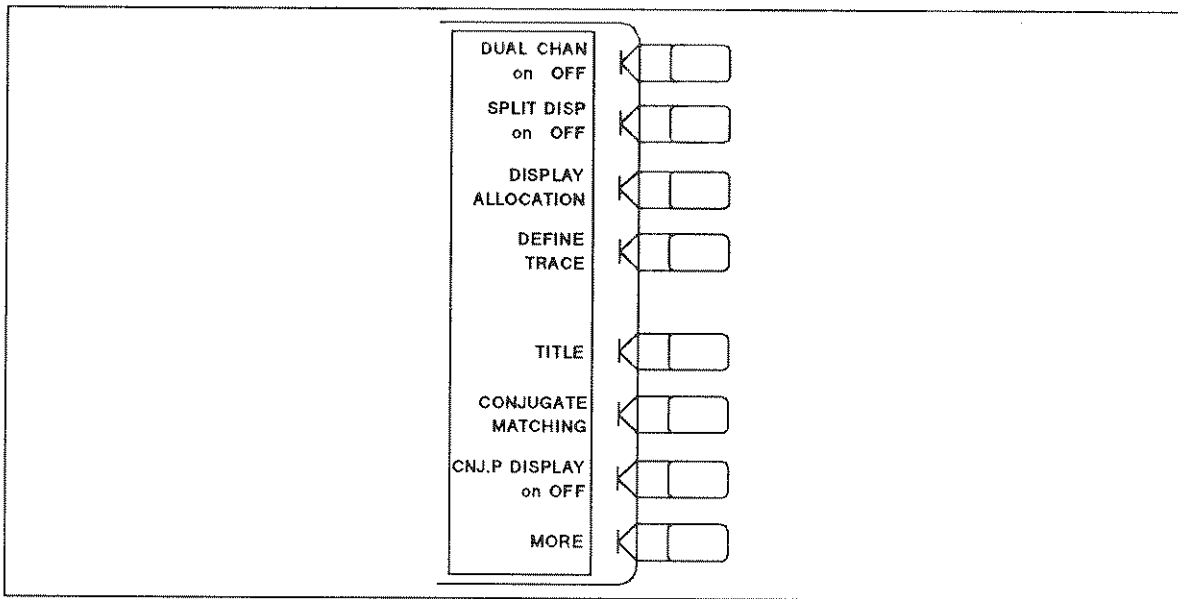

Figure 6-30. Display Menu

DUAL CHAN on OFF (DUACON, DUACOFF) toggles between display of both measurement channels or the active channel only. This is used in conjunction with **SPLIT DISP ON off** to display both channels.

Problems with Dual Channel Mode

If you are using dual channel, there are two measurement configurations which may not appear to function “properly”.

The three configurations, shown below, would cause repeated switching the output power switch and the test port transfer switch. To avoid premature wearing out of these mechanical devices, the test set will not allow these measurements to occur without direct intervention by the operator:

Channel 1 is driving one test port and channel 2 is driving the other. For example, you are making an S_{21} measurement on channel 1 and an S_{12} measurement on channel 2. This configuration, if allowed unchecked, would cause the test port transfer switch to continually cycle.

Channel 1 requires one output power level, and channel 2 requires a different value.

If the HP 85046A/B S-parameter test set is used, in a test set with internal attenuator, channel 1 requires one attenuation value, and channel 2 requires a different value. Since one attenuator is used for both test ports, this would cause the attenuator to continuously switch settings.

If one of the above conditions exist, the test set hold mode will engage, and the status notation “msh” will appear on the left side of the screen. The hold mode may be overridden by either the **MEASURE RESTART** or **NUMBER of GROUPS** softkeys under the **MENU** key, as described in Chapter 5. For more information, refer to “**MECHANICAL SWITCH HOLD**” in Chapter 5.

SPLIT DISP on OFF (SPLDON, SPLDOFF) toggles between a full-screen single graticule display of one or both channels, and a split display with two half-screen graticules one above the other. Both displays are illustrated in Figure 6-31. The split display can be used in conjunction with **DUAL CHAN ON** to show the measured data of each channel simultaneously on separate graticules. In addition, the stimulus functions of the two channels can be controlled independently using **COUPLED CH OFF** in the stimulus menu. The markers can also be controlled independently for each channel using **MARKERS: UNCOUPLED** in the marker mode menu.

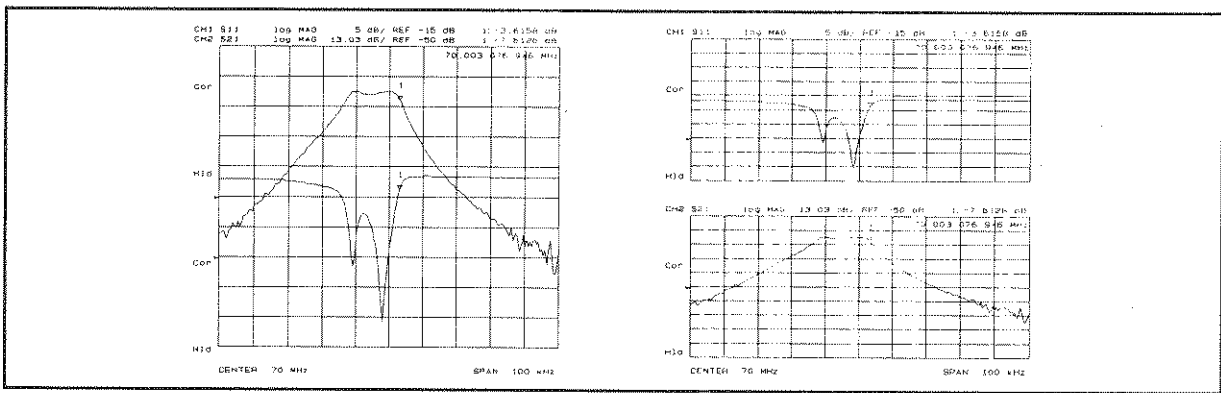

Figure 6-31. Full-screen and Split Display

DISPLAY ALLOCATION appears only when the analyzer is equipped with Instrument BASIC (Option 002). This brings up the allocation menu which selects a full-screen display of measured data or the Instrument BASIC display, and a split display with two half-screens, one graticule display above the Instrument BASIC display.

DEFINE TRACE leads to the trace math menu, which defines a trace from measurement data and memory data.

TITLE (TITL) presents the title menu in the softkey labels area and the character set in the active entry area. These label the active channel display.

CONJUGATE MATCHING presents the conjugate matching menu, which select a proper matching circuit and calculate the device parameters, to match the system characteristic impedance. Simulation is also provided using the matching circuit.

CNJ. P DISP on OFF (CONPDISPON, CONPDISPOFF) toggles the indicator of the conjugate matching circuit parameters ON or OFF on the display. This will be useful when making a hard copy of the conjugate matched DUT’s trace.

MORE leads to the display more menu.

Display More Menu

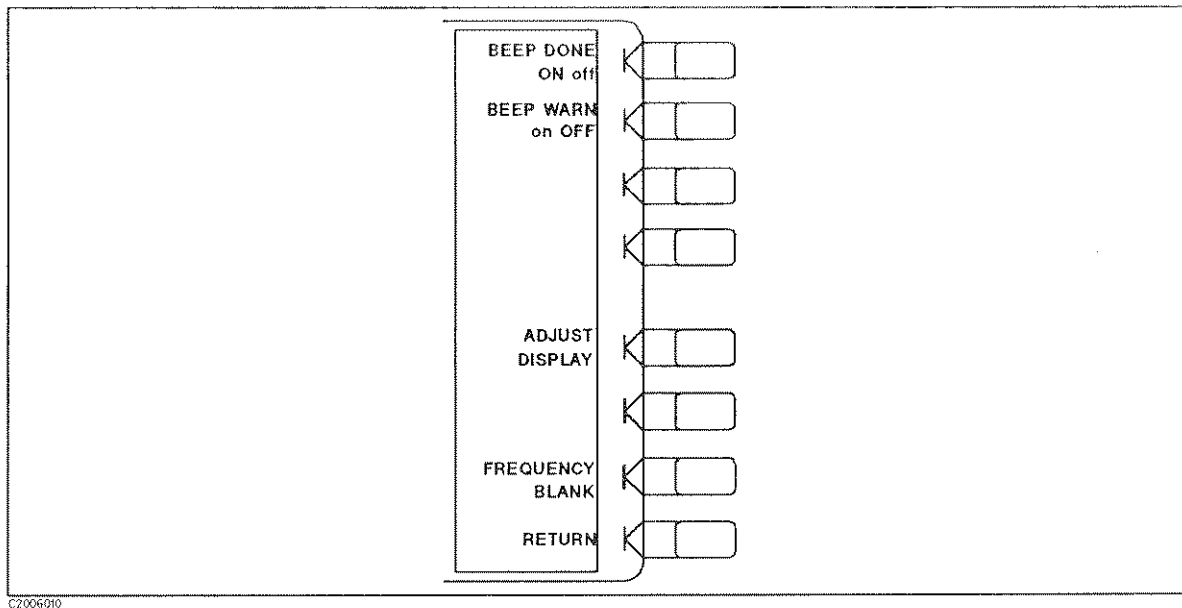

Figure 6-32. Display More Menu

BEEP DONE ON off (BEEPDONEON, BEEPDONEOFF) toggles an annunciator which sounds to indicate completion of certain operations such as calibration or instrument state save.

BEEP WARN on OFF (BEEPWARNON, BEEPWARNOFF) toggles the warning annunciator. When the annunciator is ON it sounds a warning when a cautionary message is displayed.

ADJUST DISPLAY provides a menu for adjusting display intensity, colors, and accessing save and recall functions for modified display color sets.

FREQUENCY BLANK (FREQ) blanks the displayed frequency notation for security purposes. Frequency labels cannot be restored except by instrument preset or turning the power off and then on.

RETURN goes back to the display menu.

Display Allocation Menu

Note



This menu will be available for the analyzer equipped with Instrument BASIC (Opt. 002). Otherwise, this will not be provided.

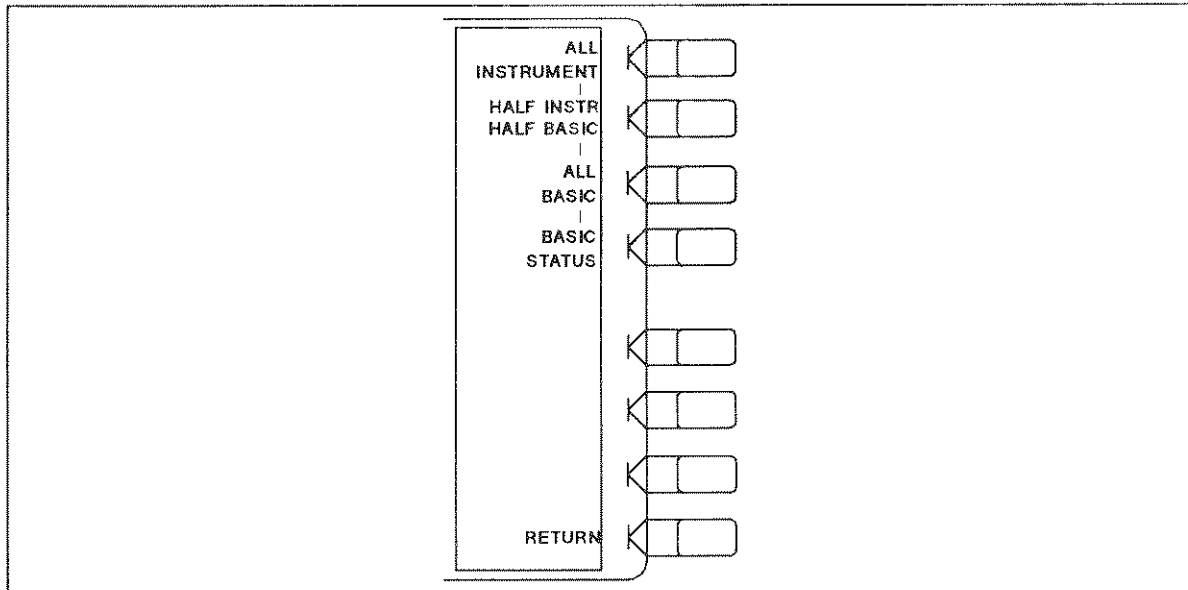

Figure 6-33. Display Allocation Menu

ALL INSTRUMENT (DISAALLI) selects a full screen single screen or two half-screen graticules.

HALF INSTR HALF BASIC (DISAHIHB) selects two half-screens, one graticule display above the Instrument BASIC display.

ALL BASIC (DISAALLB) selects a full screen single Instrument BASIC display.

BASIC STATUS selects a full screen graticule and three status lines for Instrument BASIC under the graticule.

RETURN goes back to the display menu.

Trace Math Menu

The analyzer has two available memory traces, one per channel. Memory traces are totally channel dependent: channel 1 cannot access the channel 2 memory trace or vice versa. Memory traces can be saved with the built-in FDD: one memory trace can be saved per channel per saved file on a disk. The memory data is stored as double precision, complex data. Refer to Chapter 11.

Two trace math operations are available, data/memory and data-memory. (Note that normalization is data/memory not data-memory.) Trace math is done immediately after error correction. This means that any data processing done after error correction, including parameter conversion, scaling, etc., can be performed on the memory trace. (Refer to "DATA

PROCESSING” in Chapter 1.) Trace math can also be used as a simple means of error correction, although that is not its main purpose.

The memory trace is cleared on instrument preset, power on, or instrument state recall.

If sweep mode, sweep range or number of points is different between the data and memory traces, trace math is allowed, and no warning message is displayed.

If trace math or display memory is requested and no memory trace exists, the message “CAUTION: NO VALID MEMORY TRACE” is displayed.

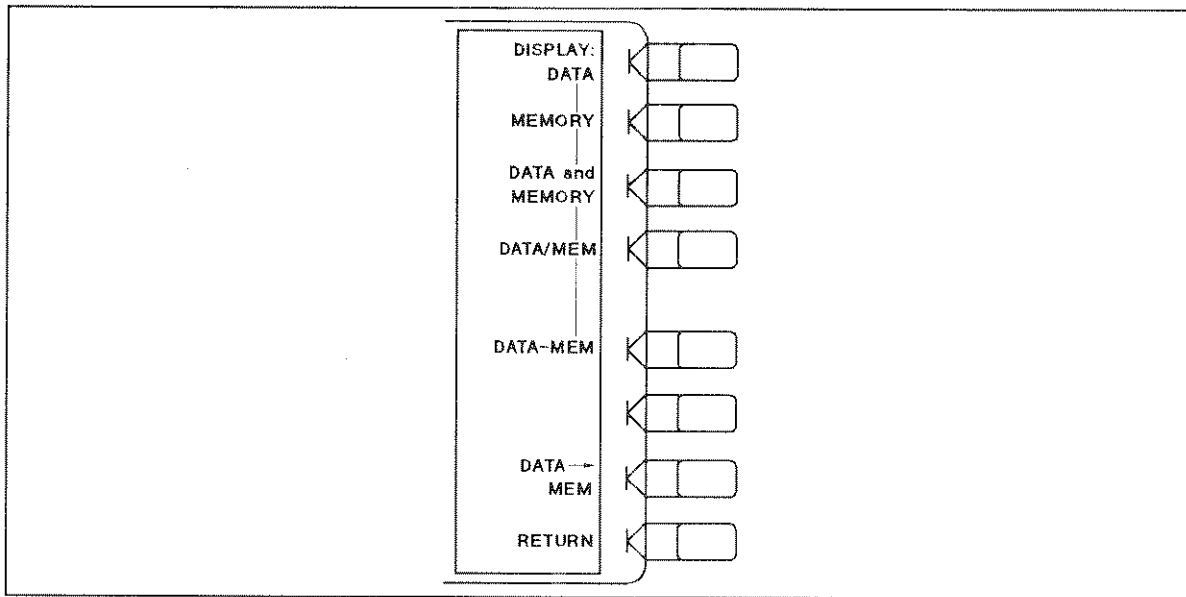

Figure 6-34. Trace Math Menu

DISPLAY: DATA (DISPDATA) displays the current measurement data trace for the active channel.

MEMORY (DISPMEMO) displays the trace memory for the active channel. If no data has been stored in memory for this channel, a warning message is displayed.

DATA and MEMORY (DISPDATM) displays both the current data and the memory traces.

DATA/MEM (DISPDMM) divides the data by the memory, normalizing the data to the memory, and displays the result. This is useful for ratio comparison of two traces, for instance in measurements of gain or attenuation.

DATA-MEM (DISPDMM) subtracts the memory from the data. The vector subtraction is performed on the complex data. This is appropriate for storing a measured vector error, for example directivity, and later subtracting it from the device measurement.

DATA → MEM (DATI) stores the current active measurement data in the memory of the active channel. It then becomes the memory trace, for use in subsequent math manipulations or display.

RETURN goes back to the display menu.

Title Menu

Use this menu to specify a title for the active channel. The title identifies the display regardless of stimulus or response changes, and is printed or plotted with the data.

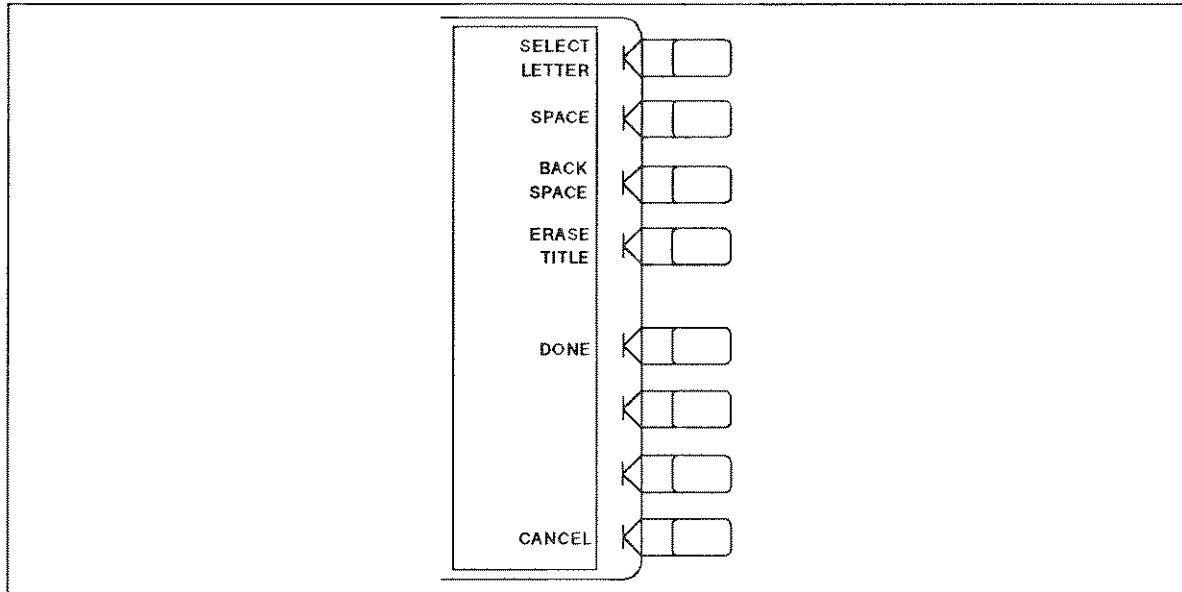

C2006011

Figure 6-35. Title Menu

SELECT LETTER The active entry area displays the letters of the alphabet, digits 0 through 9, and some special characters including mathematical symbols. Three sets of letters can be scrolled using the step keys, \uparrow and \downarrow . To define a title, press step keys for the desired letter set, rotate the knob until the arrow “↑” points at the first letter, then press **SELECT LETTER**. As each letter is selected, it is appended to the title at the top of the graticule. Repeat this until the complete title is defined, a maximum of 53 letters. It is also possible to input the letters from the keyboard provided with Instrument BASIC (Option 002).

SPACE inserts a space in the title.

BACK SPACE deletes the last character entered.

ERASE TITLE deletes the entire title.

DONE terminates the title entry, and returns to the display more menu.

CANCEL cancels the title entry and returns to the display more menu without any change.

Conjugate Matching Menu

This menu selects a proper matching circuit and calculates the device parameters in the selected matching circuit.

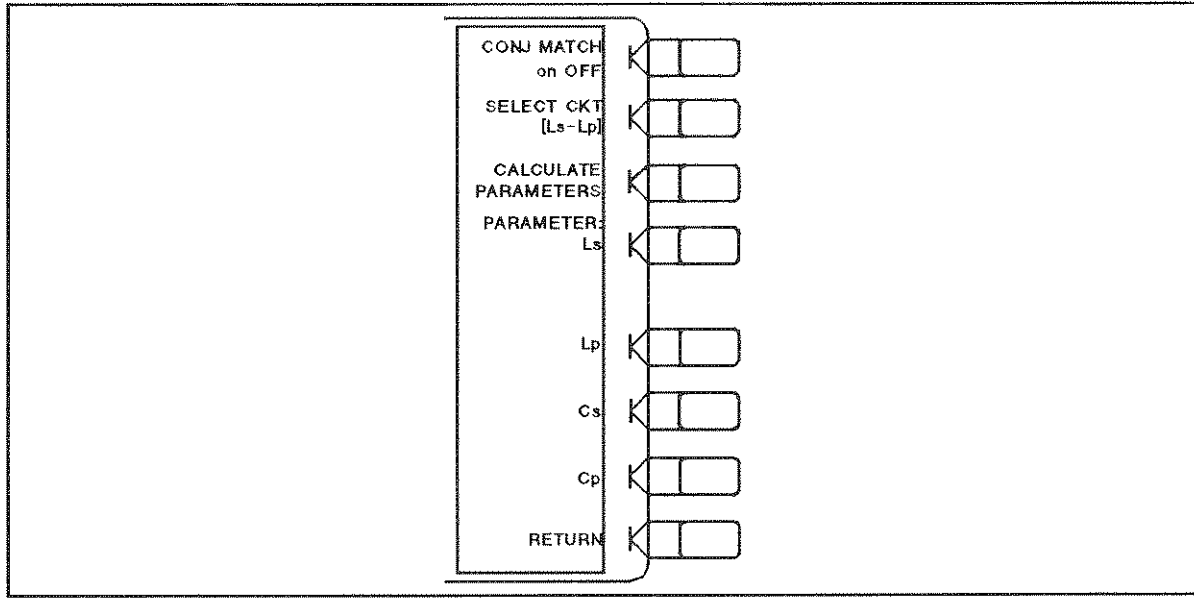

Figure 6-36. Conjugate Matching Menu

The conjugate matching function is useful for obtaining optimum power transfer, in other words, maximum return loss, at a specific frequency point.

According to the DUT's reflection characteristics at the active marker frequency on the Smith chart, a matching (conjugate) circuit is selected from among the eight provided circuit types shown in Figure 6-37, and the device parameters of this circuit is calculated. This two-element matching circuit matches the DUT's input impedance to the system impedance Z_0 (e.g. 50Ω). The reflection characteristics for the matched DUT is simulated and displayed.

Other possible circuits can also be selected and the parameters calculated.

In addition, the calculated parameters can be modified for commercially available values for example and the respective characteristics are calculated and displayed automatically.

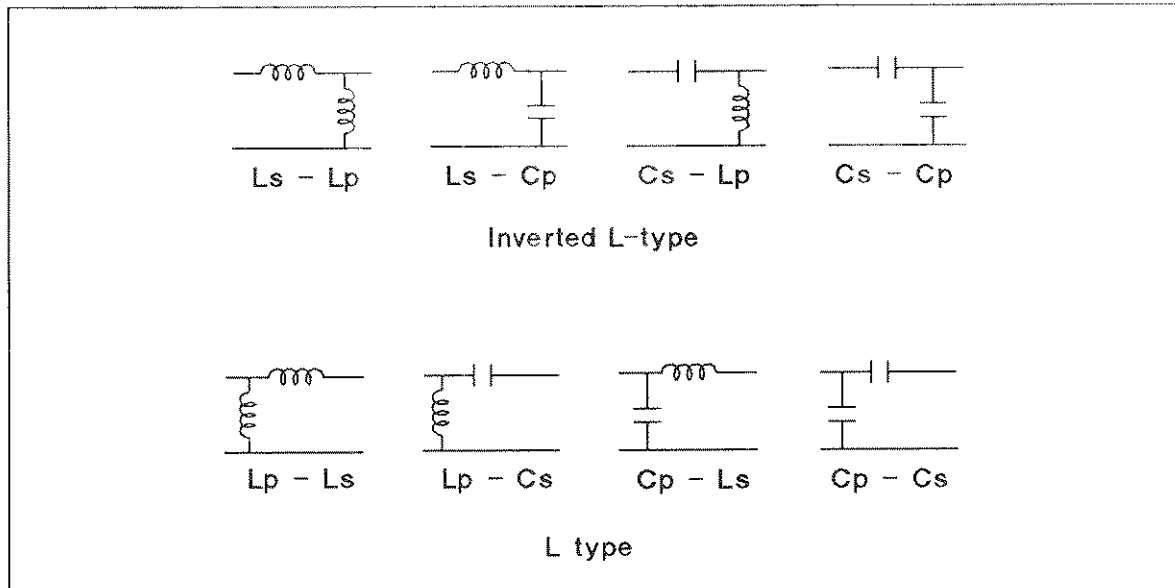

Figure 6-37. Matching Circuits

CONJ MATCH on **OFF** (**COMMON**, **CONMOFF**) toggles the conjugate matching ON or OFF.

SELECT CKT [Ls-Lp] (**SELEC**) brings up the select circuit menu to select a current matching circuit for conjugate matching.

CALCULATE PARAMETERS (**CALP**) calculates the parameters of the selected matching circuit. Make sure the display format is the Smith chart when pressing this softkey.

PARAMETER: Ls (**CONPLS**) displays or changes the parameter value "Ls" for the selected matching circuit.

Lp (**CONPLP**) displays or changes the parameter value "Lp" for the selected matching circuit.

Cs (**CONPCS**) displays or changes the parameter value "Cs" for the selected matching circuit.

Cp (**CONPCP**) displays or changes the parameter value "Cp" for the selected matching circuit.

RETURN goes back to the display more menu.

Select Circuit Menu

This selects the matching circuit from among the eight circuit types. A "*" is displayed on the left side of the softkeys of circuits which can match the impedance at the frequency position of the active marker.

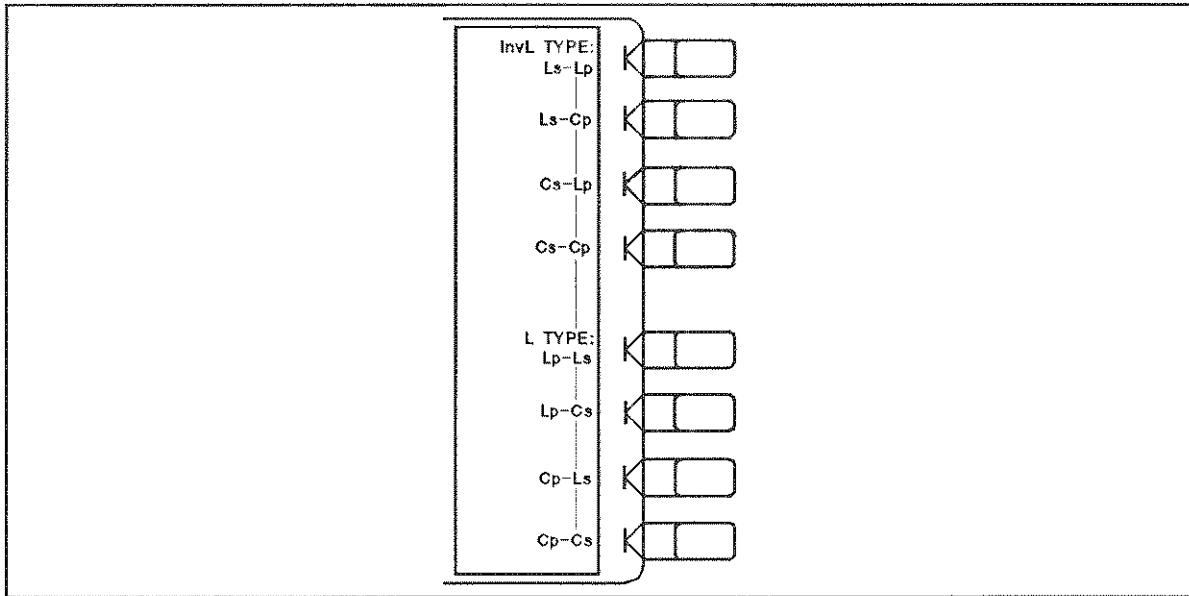

Figure 6-38. Select Circuit Menu

InvL TYPE: Ls-Lp (SELCLSLP) selects the "Ls-Lp" circuit for the conjugate matching.

Ls-Cp (SELECLSCP) selects the "Ls-Cp" circuit for the conjugate matching.

Cs-Lp (SELECCSLP) selects the "Cs-Lp" circuit for the conjugate matching.

Cs-Cp (SELECCSCP) selects the "Cs-Cp" circuit for the conjugate matching.

L TYPE: Lp-Ls (SELECLPLS) selects the "Lp-Ls" circuit for the conjugate matching.

Lp-Cs (SELECLPCS) selects the "Lp-Cs" circuit for the conjugate matching.

Cp-Ls (SELECCPLS) selects the "Cp-Ls" circuit for the conjugate matching.

Cp-Cs (SELECCPCS) selects the "Cp-Cs" circuit for the conjugate matching.

Adjust Display Menu

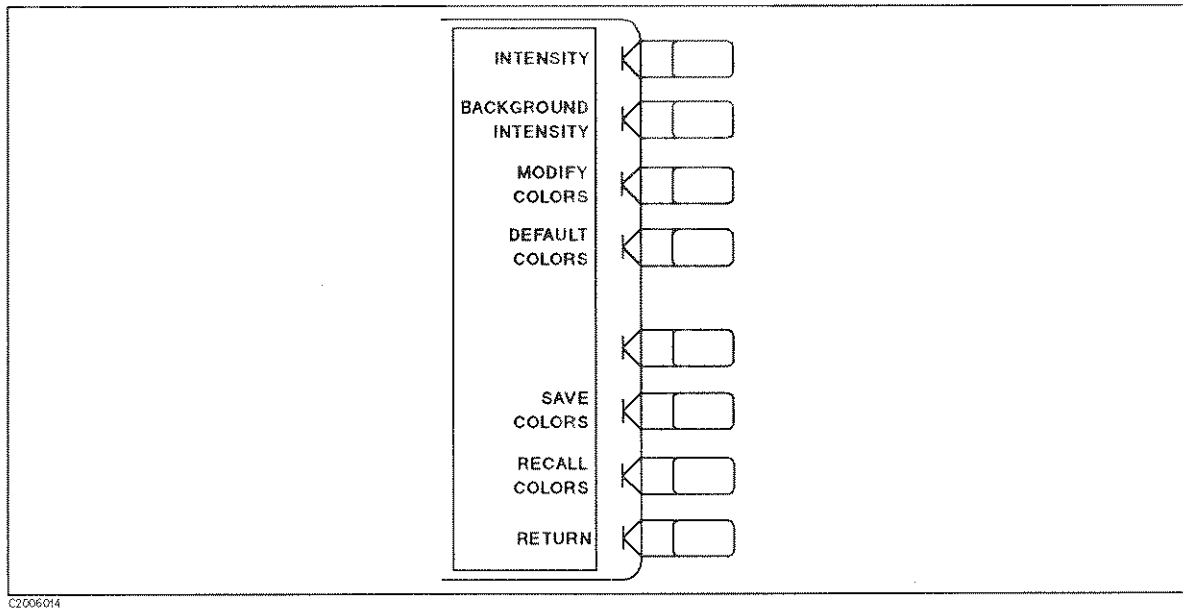

Figure 6-39. Adjust Display Menu

INTENSITY (INTE) sets the display intensity as a percent of the brightest setting.

BACKGROUND INTENSITY (BACI) sets the background intensity of the display as a percent of the white level.

MODIFY COLORS present the modify colors menu for color modification of display elements. Refer to Adjusting Color later in this chapter for information on modifying display elements.

DEFAULT COLORS (DEFC) returns all the color settings back to the factory-set default values.

SAVE COLORS (SVC0) saves the modified version of the color set to the non-volatile memory.

RECALL COLORS (RECC) recalls the previously saved modified version of the color set from the non-volatile memory. This key appears only when a color set has been saved.

RETURN goes back to the display more menu.

Modify Colors Menu

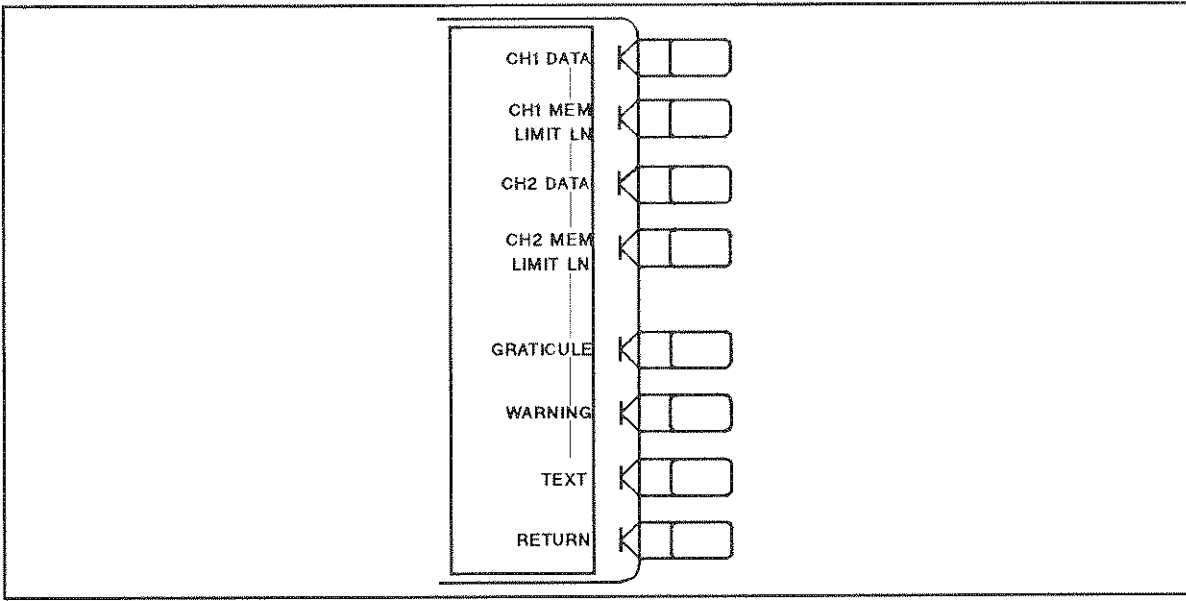

Figure 6-40. Modify Colors Menu

CH1 DATA (COLOCH1D) selects channel 1 data trace for color modification.

CH1 MEM LIMIT LN (COLOCH1M) selects channel 1 memory trace and limit line for color modification.

CH2 DATA (COLOCH2D) selects channel 2 data trace for color modification.

CH2 MEM LIMIT LN (COLOCH2M) selects channel 2 memory and the reference line and limit line for color modification.

GRATICULE (COLOGRAT) selects the graticule and a portion of softkey text (where there is a choice of a feature being ON or OFF) for color modification.

WARNING (COLOWARN) selects the warning annotation for color modification.

TEXT (COLOTEXT) selects all the non-data text for color modification. For example: softkey labels.

RETURN goes back to the adjust display menu.

Color Adjust Menu

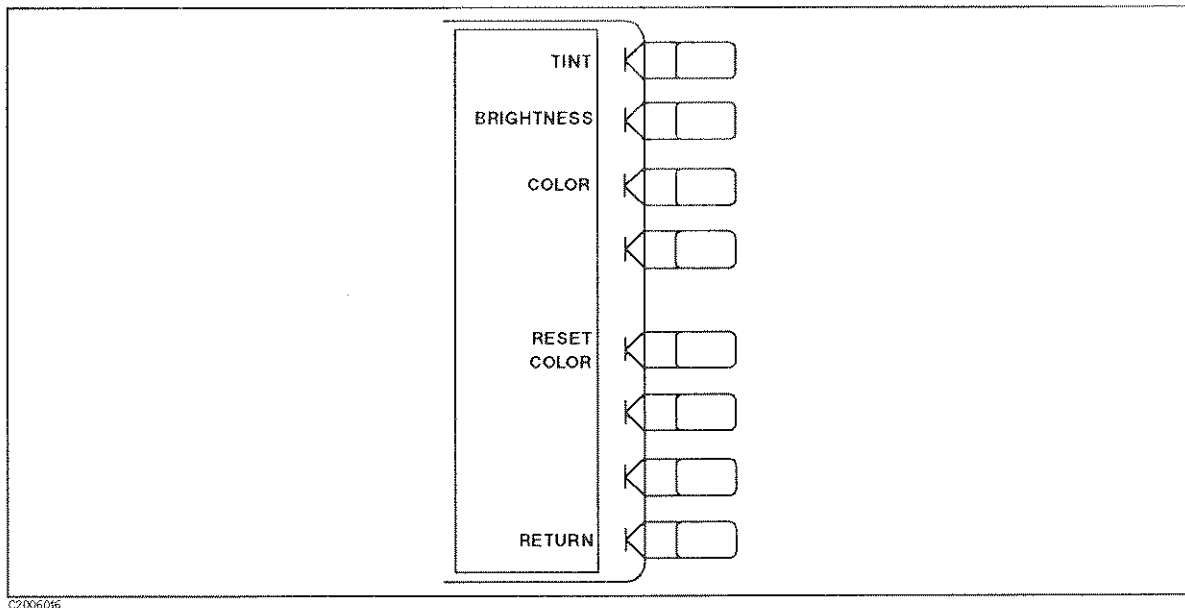

Figure 6-41. Color Adjust Menu

TINT (TINT) adjusts the hue of the chosen attribute. See Adjusting Color for an explanation of using this softkey for color modification of display attributes.

BRIGHTNESS (CBRI) adjusts the brightness of the color being modified. See Adjusting Color for an explanation of using this softkey for color modification of display attributes.

COLOR adjusts the degree of whiteness of the color being modified. See Adjusting Color for an explanation of using this softkey for color modification of display attributes.

RESET COLOR (RSCO) resets the color being modified to the default color.

RETURN goes back to the modify colors menu.

Adjusting Color

This procedure explains how to adjust the colors on the analyzer display. The default color in this instrument have been scientifically chosen to maximize your ability to discern the difference between the colors, and to comfortably and effectively view the colors. These colors are recommended for normal use because they will provide a suitable contrast that is easy to view for long period of time.

You may want to change colors to suit environmental needs, individual preferences, or to accommodate color deficient vision. You can use any of the available colors for any of the seven display elements listed by the softkey names below:

- CH1 DATA
- CH1 MEM LIMIT LN
- CH2 DATA

- CH2 MEM LIMIT LN
- GRATICULE
- WARNING
- TEXT

To change the color of a display element, press the softkey for that element (such as CH1 DATA). Then press TINT and turn the knob until the desired color appears. The step keys or numeric keypad can also be used.

Color is comprised of three parameters:

Tint The continuum of hues on the color wheel, ranging from red through green and blue, and back to red.

Brightness A measure of the brightness of the color.

Color The degree of whiteness of the color. A scale from white to pure color.

The most frequently occurring color deficiency is the inability to distinguish red, yellow, and green from one another. Confusion between these colors can usually be eliminated by increasing the brightness between the colors. To do this, press the BRIGHTNESS softkey and turn the knob. If adjustment is needed, vary the degree of whiteness of the color. To do this, press the COLOR softkey and turn the knob.

Note Color changes and adjustments remain effect until changed again in these menus or the analyzer is turned off. Preset and instrument state recall do not affect the selected colors.



Setting Default Colors

To set all the display elements to the factory-defined default colors, press:

DISPLAY MORE ADJUST DISPLAY DEFAULT COLORS

Saving Modified Colors

To save the modified color set to the non-volatile memory, press:

DISPLAY MORE ADJUST DISPLAY SAVE COLORS

Modified colors are not part of a saved instrument state and are lost unless saved using these softkeys.

Recalling Modified Colors

To recall the previously saved color set from the non-volatile memory, press:

DISPLAY MORE ADJUST DISPLAY RECALL COLORS

AVG KEY

The HP-IB programming command is shown in parenthesis following the key or softkey.

The **AVG** key accesses four different noise reduction techniques: sweep-to-sweep averaging, display smoothing, variable IF bandwidth, and group delay aperture for group delay measurement. Any or all of these can be used simultaneously. Averaging, smoothing and group delay aperture can be set independently for each channel, and the IF bandwidth can be set independently if the stimulus is uncoupled.

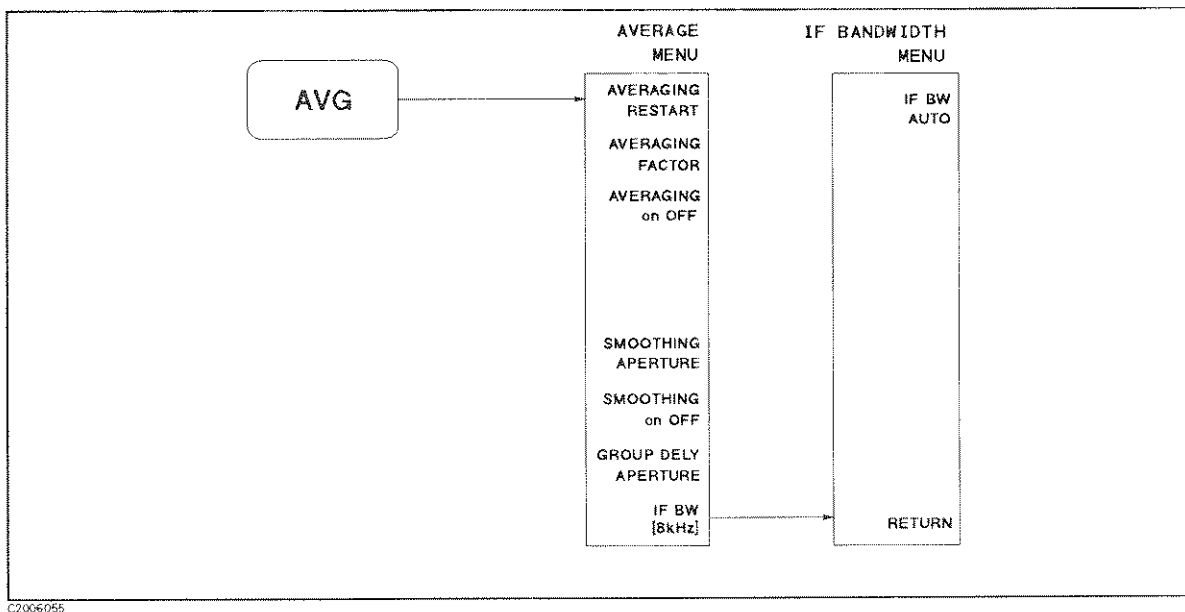

C2006055

Figure 6-42. Softkey Menus Accessed from the **AVG** Key

Averaging

Averaging computes each data point based on an exponential average of consecutive sweeps weighted by a user-specified averaging factor. Each new sweep is averaged into the trace until the total number of sweeps is equal to the averaging factor, for a fully averaged trace. Each point on the trace is the vector sum of the current trace data and the data from the previous sweep. A high averaging factor gives the best signal-to-noise ratio, but slows the trace update time. Doubling the averaging factor reduces the noise by 3 dB. Figure 6-43 illustrates the effect of averaging on a log magnitude format trace.

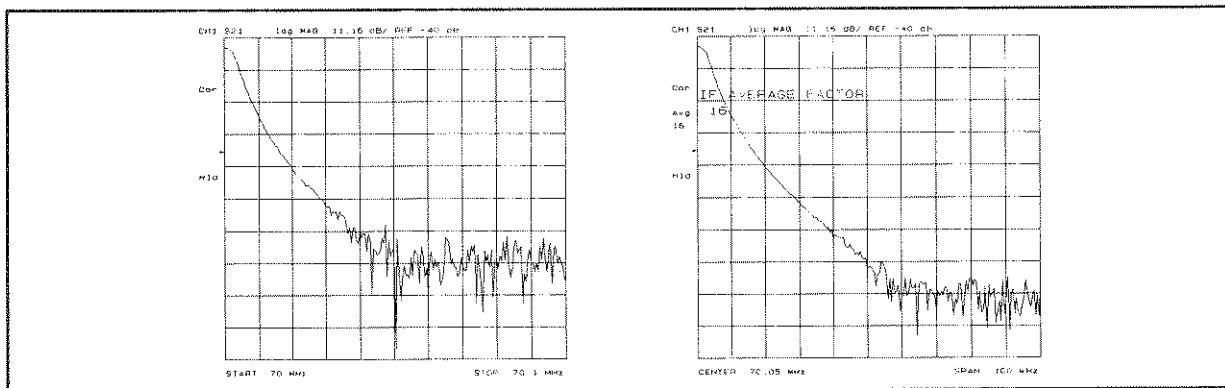

Figure 6-43. Effect of Averaging on a Trace

Smoothing

Smoothing (similar to video filtering) averages the formatted active channel data over a portion of the displayed trace. Smoothing computes each displayed data point based on one sweep only, using a moving average of several adjacent data points for the current sweep. The smoothing aperture is a percent of the stimulus span swept, up to a maximum of 100%.

Rather than lowering the noise floor, smoothing finds the mid-value of the data. Use it to reduce relatively small peak-to-peak noise values on broadband measured data. Use a sufficiently high number of display points to avoid misleading results. Do not use smoothing for measurements of high Q resonant devices or other devices with wide variations in the trace, as it will introduce errors into the measurement.

In polar display format, large phase shifts over the smoothing aperture will cause shifts in amplitude, since a vector average is being computed. Figure 6-44 illustrates the effect of smoothing on a log magnitude format trace.

If data and memory traces are displayed, smoothing is performed on both of them.

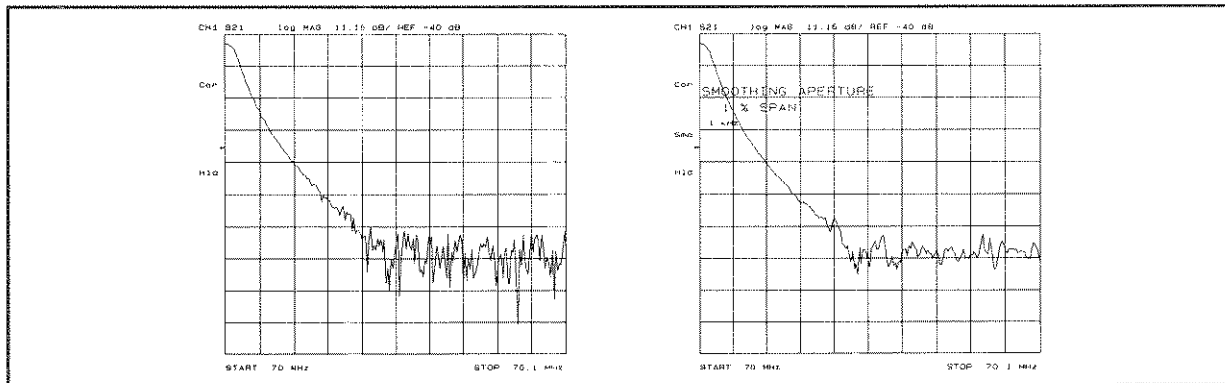

Figure 6-44. Effect of Smoothing on a Trace

IF Bandwidth Reduction

IF Bandwidth Reduction lowers the noise floor by reducing the receiver input bandwidth. It has an advantage over averaging in reliably filtering out unwanted responses such as spurs, odd harmonics, higher frequency spectral noise, and line-related noise. Sweep-to-sweep averaging, however, is better at filtering out very low frequency noise. A tenfold reduction in IF bandwidth (from 200 Hz to 20 Hz, for example) lowers the measurement noise floor by about 10 dB.

Another difference between sweep-to-sweep averaging and variable IF bandwidth is the sweep time. Averaging displays the first complete trace faster but takes several sweeps to reach a fully averaged trace. IF bandwidth reduction lowers the noise floor in one sweep, but the sweep time may be slower. Figure 6-45 illustrates the difference in noise floor between a trace measured with a 1 kHz IF bandwidth and with a 2 Hz IF bandwidth.

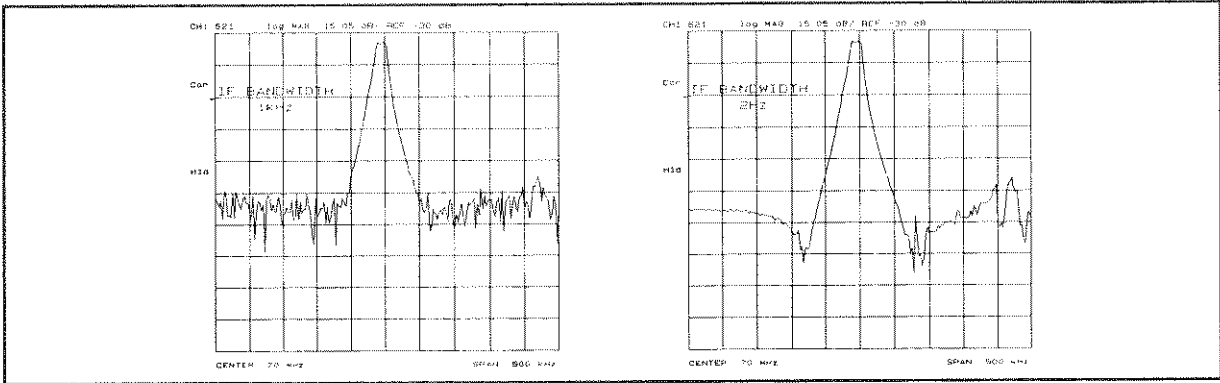

Figure 6-45. IF Bandwidth Reduction

Group Delay Aperture

Changing group delay aperture will lower the noise on the group delay trace. Refer to Group Delay Principles earlier in this chapter.

Another capability that can be used for effective noise reduction is the marker statistics function, which computes the average value of part or all of the formatted trace. Refer to Chapter 8.

Average Menu

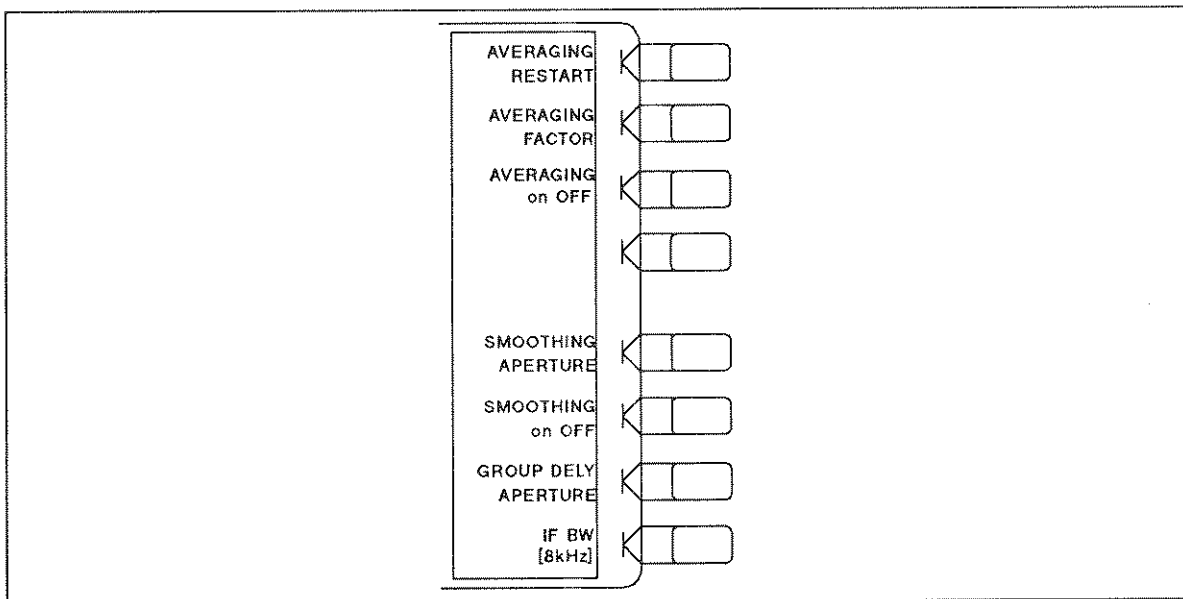

C2006017

Figure 6-46. Average Menu

AVERAGING RESTART (AVERREST) resets the sweep-to-sweep averaging and restarts the sweep count at 1 at the beginning of the next sweep. The sweep count for averaging is displayed at the left of the display.

AVERAGING FACTOR (AVERFACT) makes averaging factor the active function. Any value up to 999 can be used. The algorithm used for averaging is:

$$A_{(n)} = \frac{S_{(n)}}{F} + \left(1 - \frac{1}{F}\right) \times A_{(n-1)}$$

where

A(n) = current average

S(n) = current measurement

F = average factor

AVERAGING on OFF (AVERON, AVEROFF) turns the averaging function ON or OFF for the active channel. "Avg" is displayed in the status notations area at the left of the display, together with the sweep count for the averaging factor, when averaging is ON. The sweep count for averaging is reset to 1 whenever an instrument state change affecting the measured data is made.

At the start of averaging or following **AVERAGING RESTART**, averaging starts at 1 and averages each new sweep into the trace until it reaches the specified averaging factor. The sweep count is displayed in the status notations area below "Avg" and updated every sweep as it increments. When the specified averaging factor is reached, the trace data continues to be updated, weighted by that averaging factor.

SMOOTHING APERTURE (SMOOPER) lets you change the value of the smoothing aperture as a percent of the span. When smoothing aperture is the active function, its value in stimulus units is displayed below its percent value in the active entry area. Allowed range is 0.05 through 100 % of span and resolution is 0.001%.

SMOOTHING on OFF (SMOON, SMOOFF) turns the smoothing function ON or OFF for the active channel. When smoothing is ON, the annotation "Smo" is displayed in the status notations area. The algorithm used for smoothing is:

$$S_{m(n)} = \frac{D_{(n-m)} + \dots + D_{(n)} + \dots + D_{(n+m)}}{2m + 1}$$

where

Sm(n) = smoothed data

D(n) = unsmoothed data

m : decided from smoothing aperture

GROUP DELAY APERTURE (GRODAPER) sets the aperture for group delay measurements as a percent of the span (refer to Group Delay Principles earlier in this chapter). A frequency aperture Δf at the active marker is displayed under the percent value when the format is DELAY.

IF BW (IFBW) selects the bandwidth value for IF bandwidth reduction. Allowed values (in Hz) are 4 k, 1 k, 200, 20, and 2. Any other value will default to the closest allowed value. A narrow bandwidth slows the sweep speed but provides better signal-to-noise ratio. The selected bandwidth value is shown in brackets in the softkey label.

IF Bandwidth Menu

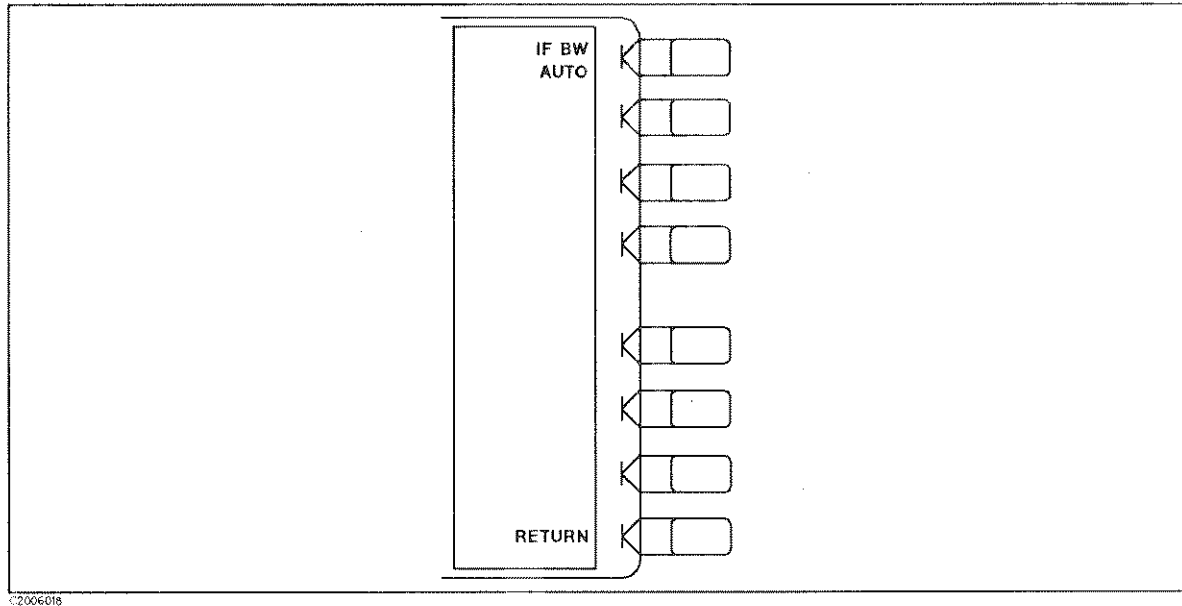

Figure 6-47. IF Bandwidth Menu

IF BW AUTO (IFBWAUTO) selects the proper IF bandwidth automatically for each measurement point while the measuring frequency is swept. This is convenient to get fast and good performance when the log frequency sweep type is selected.

The best bandwidth depends on the measuring frequency. The relations between measuring frequency and IF bandwidth are as follows:

Table 6-1. IF Bandwidth in AUTO mode

Frequency		IF Bandwidth
5 Hz	to 199.999 Hz	2 Hz
200 Hz	to 1.999 999 kHz	20 Hz
2 kHz	to 99.999 999 kHz	200 Hz
100 kHz	to 999.999 999 kHz	1 kHz
1 MHz	to 500 MHz	4 kHz

RETURN goes back to the average menu.

ATTEN KEY

This key provides the attenuator menu which selects the analyzer's three internal attenuator values, 0 or 20 dB, for inputs A, B, and R.

Attenuator Menu

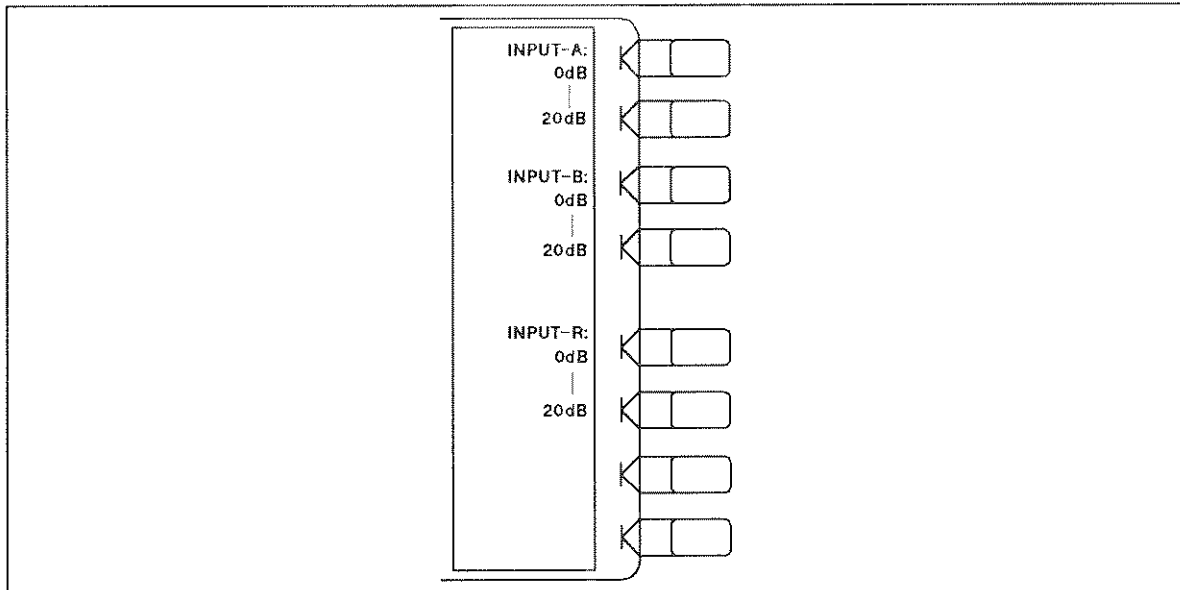

Figure 6-48. Attenuator Menu

INPUT-A: 0dB (ATTIA0DB) sets the attenuator in input A to 0 dB.

20dB (ATTIA20DB) sets the attenuator in input A to 20 dB.

INPUT-B: 0dB (ATTIB0DB) sets the attenuator in input B to 0 dB.

20dB (ATTIB20DB) sets the attenuator in input B to 20 dB.

INPUT-R: 0dB (ATTIRODB) sets the attenuator in input R to 0 dB.

20dB (ATTIR20DB) sets the attenuator in input R to 20 dB.

Contents

7. Measurement Calibration	
INTRODUCTION	7-1
ACCURACY ENHANCEMENT	7-1
SOURCES OF MEASUREMENT ERRORS	7-2
Directivity	7-2
Source Match	7-3
Load Match	7-4
Isolation (Crosstalk)	7-5
Frequency Response (Tracking)	7-6
CORRECTING FOR MEASUREMENT ERRORS	7-6
MENUS AND SOFTKEYS	7-8
CAL Key	7-8
Standard Devices	7-9
Interpolated Error Correction	7-9
Channel Coupling	7-9
Measurement Parameters	7-10
Device Measurements	7-10
Omitting Isolation Calibration	7-10
Stopping During the Calibration Procedure	7-10
Saving Calibration Data	7-10
Specifying Calibration Kits	7-10
Correction Menu	7-11
Select Cal Kit Menu	7-12
Calibrate More Menu	7-14
Reference Plane Menu	7-15
DC Correction Menu	7-16
Calibration Menu	7-17
Response Calibration for Reflection Measurements	7-20
Response Calibration for Transmission Measurements	7-21
Response and Isolation Calibration for Reflection Measurements	7-22
Response and Isolation Calibration for Transmission Measurements	7-24
S ₁₁ 1-Port Calibration for Reflection Measurements	7-25
S ₂₂ 1-Port Calibration	7-26
Full 2-Port Calibration for Reflection and Transmission Measurements	7-27
One-Path 2-Port Calibration for Reflection and Transmission Measurements	7-31
MODIFYING CALIBRATION KITS	7-34
Definitions	7-35
Procedure	7-35
Modify Cal Kit Menu	7-35
Define Standard Number Menu	7-37
Define Standard Menus	7-37
Specify Offset Menu	7-41

5

Label Standard Menu	7-42
Specify Class Menus	7-42
Label Class Menus	7-45
Label Kit Menu	7-45
Verify Performance	7-46
Example Procedure for Specifying a User-Defined Calibration Kit	7-46
APPENDIX TO CHAPTER 7	7-47
Accuracy Enhancement Fundamentals-Characterizing Systematic Errors	7-47
One-Port Error Model	7-47
Measuring reflection coefficient	7-48
Directivity error	7-48
Source match error	7-48
Frequency response error	7-49
How calibration standards are used to quantify these error terms	7-49
Two-Port Error Model	7-52
Measuring Transmission Coefficient	7-52
Load Match Error	7-53
Isolation Errors	7-53
Error Terms the Analyzer Can Reduce	7-54

Figures

7-1. Directivity	7-3
7-2. Source Match	7-4
7-3. Load Match	7-5
7-4. Response vs. S_{11} 1-Port Calibration on Log Magnitude Format	7-7
7-5. Response vs. Full Two-Port Calibration	7-7
7-6. Softkey Menus Accessed from the CAL Key	7-8
7-7. Correction Menu	7-11
7-8. Select Cal Kit Menu	7-13
7-9. Calibrate More Menu	7-14
7-10. Reference Plane Menu	7-15
7-11. DC Correction Menu	7-16
7-12. Calibration Menu	7-18
7-13. Response Cal Menu	7-20
7-14. Response and Isolation Cal Menu and Response Cal Menu	7-22
7-15. S_{11} and S_{22} 1-Port Cal Menus	7-25
7-16. Full 2-Port Cal Menu	7-28
7-17. One-Path 2-Port Cal Menu	7-32
7-18. Modify Cal Kit Menu	7-36
7-19. Define Standard Number Menu	7-37
7-20. Define Standard Menus	7-39
7-21. Specify Offset Menu	7-41
7-22. Label Standard Menu	7-42
7-23. Specify Class Menus	7-44
7-24. Label Class Menus	7-45
7-25. Sources of Error in a Reflection Measurement	7-47
7-26. Reflection Coefficient	7-48
7-27. Effective Directivity E_{DF}	7-48
7-28. Source Match E_{SF}	7-49
7-29. Reflection Tracking E_{RF}	7-49
7-30. "Perfect Load" Termination	7-50
7-31. Measured Effective Directivity	7-50
7-32. Short Circuit Termination	7-51
7-33. Open Circuit Termination	7-51
7-34. Measured S_{11}	7-51
7-35. Major Sources of Error	7-52
7-36. Transmission Coefficient	7-52
7-37. Load Match E_{LF}	7-53
7-38. Isolation E_{XF}	7-54
7-39. Full Two-Port Error Model	7-55

Tables

7-1. Differences between PORT EXTENSIONS and ELECTRICAL DELAY	7-14
7-2. Purpose and Use of Different Calibration Procedures	7-19
7-3. Standard Definitions	7-38
7-4. Standard Class Assignments Table	7-43

Measurement Calibration

INTRODUCTION

Measurement calibration is an accuracy enhancement procedure that effectively reduces the system errors that cause uncertainty in measuring a device under test. It measures known standard devices, and uses the results of these measurements to characterize the system.

This chapter explains the theoretical fundamentals of accuracy enhancement and the sources of measurement errors. It describes the different measurement calibration procedures available in the analyzer, which errors they correct, and the measurements for which each should be used. An appendix at the end of this chapter provides further information on characterizing systematic errors and using error models to analyze overall measurement performance.

ACCURACY ENHANCEMENT

If it were possible for a perfect measurement system to exist, it would have infinite dynamic range, isolation, and directivity characteristics, no impedance mismatches in any part of the test setup, and flat frequency response. Vector accuracy enhancement, also known as measurement calibration or error correction, provides the means to simulate a perfect measurement system.

In any high frequency measurement, there are measurement errors associated with the system that contribute uncertainty to the results. Parts of the measurement setup such as interconnecting cables and signal separation devices (as well as the analyzer itself) all introduce variations in magnitude and phase that can mask the actual performance of the device under test.

For example, crosstalk due to the channel isolation characteristics of the analyzer can contribute an error equal to the transmission signal of a high-loss test device. For reflection measurements, the primary limitation of dynamic range is the directivity of the test setup. The measurement system cannot distinguish the true value of the signal reflected by the device under test from the signal arriving at the receiver input due to leakage in the system. For both transmission and reflection measurements, impedance mismatches within the test setup cause measurement uncertainties that appear as ripples superimposed on the measured data.

Measurement calibration simulates a perfect analyzer system. It measures the magnitude and phase responses of known standard devices, and compares the measurement with actual device data. It uses the results to characterize the system and effectively remove the system errors from the measurement data of a test device, using vector math capabilities internal to the analyzer.

When measurement calibration is used, the dynamic range and accuracy of the measurement are limited only by system noise and stability, connector repeatability, and the accuracy to which the characteristics of the calibration standards are known.

SOURCES OF MEASUREMENT ERRORS

Network analysis measurement errors can be separated into systematic, random, and drift errors.

Correctable systematic errors are the repeatable errors that the system can measure. These are errors due to mismatch and leakage in the test setup, isolation between the reference and test signal paths, and system frequency response.

The system cannot measure and correct for the non-repeatable random and drift errors. These errors affect both reflection and transmission measurements. Random errors are measurement variations due to noise and connector repeatability. Drift errors include frequency drift, temperature drift, and other physical changes in the test setup between calibration and measurement.

The resulting measurement is the vector sum of the device under test response plus all error terms. The precise effect of each error term depends upon its magnitude and phase relationship to the actual test device response.

In most high frequency measurements the systematic errors are the most significant source of measurement uncertainty. Since each of these errors can be characterized, their effects can be effectively removed to obtain a corrected value for the test device response. For the purpose of vector accuracy enhancement these uncertainties are quantified as directivity, source match, load match, isolation (crosstalk), and frequency response (tracking). Each of these systematic errors is described below.

Random and drift errors cannot be precisely quantified, so they must be treated as producing a cumulative uncertainty in the measured data.

Directivity

Normally a device that can separate the reverse from the forward traveling waves (a directional bridge or coupler) detects the signal reflected from the device under test. Ideally the coupler would completely separate the incident and reflected signals, and only the reflected signal would appear at the coupled output, as illustrated in Figure 7-1-a.

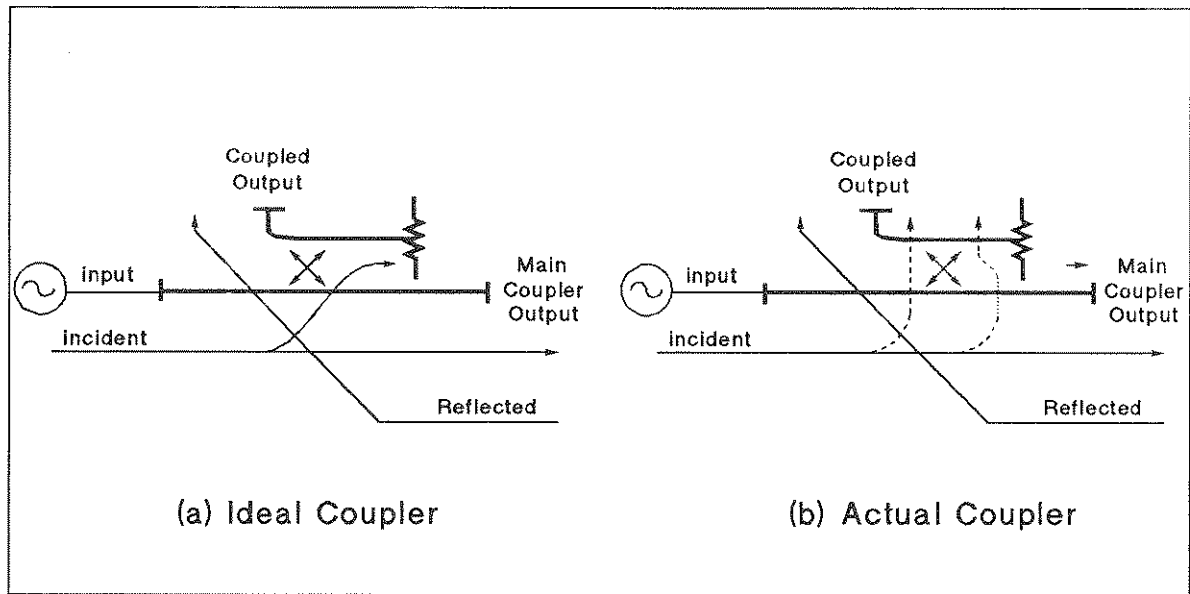

Figure 7-1. Directivity

However, an actual coupler is not perfect, as illustrated in Figure 7-1-b. A small amount of the incident signal appears at the coupled output due to leakage as well as to reflection from the termination in the coupled arm. Also, reflections from the main coupler output connector appear at the coupled output, adding uncertainty to the signal reflected from the device. The figure of merit for how well a coupler separates forward and reverse waves is directivity. The greater the directivity of the device, the better the signal separation. Directivity is the vector sum of all leakage signals appearing at the analyzer receiver input due to the inability of the signal separation device to absolutely separate incident and reflected waves, and to residual reflection effects of test cables and adapters between the signal separation device and the measurement plane. The error contributed by directivity is independent of the characteristics of the test device and it usually produces the major ambiguity in measurements of low reflection devices.

Source Match

Source match is defined as the vector sum of signals appearing at the analyzer receiver input due to the impedance mismatch at the test device looking back into the source. Source match is degraded by adapters and extra cables. A non-perfect source match leads to mismatch uncertainties that affect both transmission and reflection measurements. Source match is most often given in terms of return loss in dB: thus the larger the number, the smaller the error.

- In a reflection measurement, the source match error signal is caused by some of the reflected signal from the DUT being reflected from the source back toward the DUT and re-reflected from the DUT (Figure 7-2).
- In a transmission measurement, the source match error signal is caused by reflection from the test device that is re-reflected from the source.

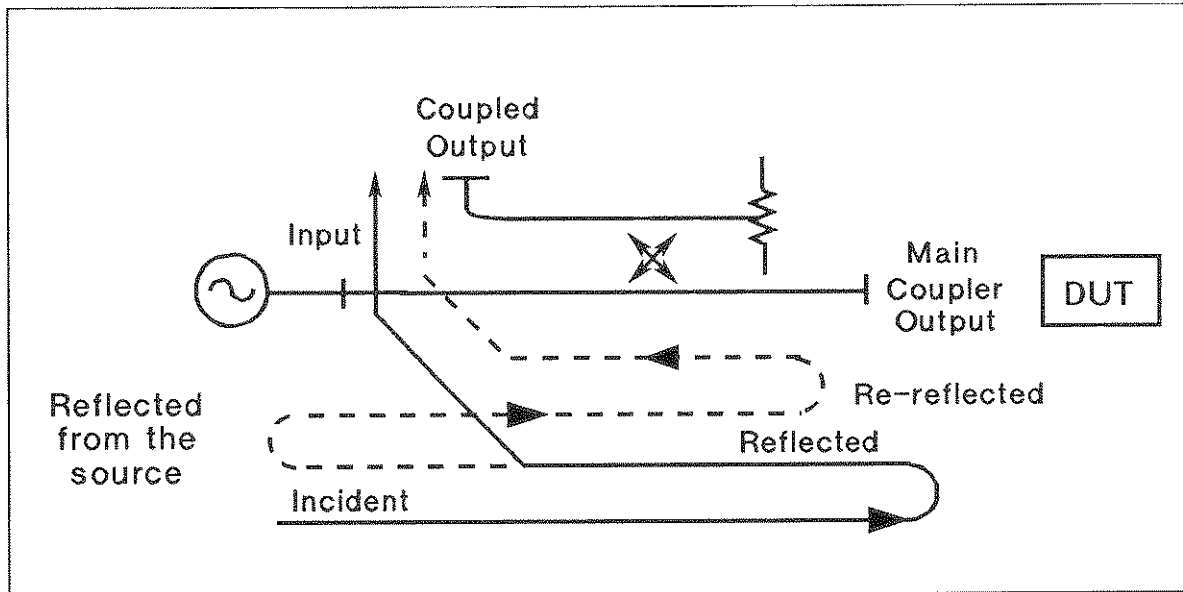

C2007043

Figure 7-2. Source Match

The error contributed by source match is a mismatch error caused by the relationship between the actual input impedance of the test device and the equivalent match of the source. It is a factor in both transmission and reflection measurements. Mismatch uncertainty is particularly a problem in measurements where there is a large impedance mismatch at the measurement plane.

Load Match

Load match error results from an imperfect match at the output of the test device. It is caused by impedance mismatches between the test device output port and port 2 of the measurement system. As illustrated in Figure 7-3, some of the transmitted signal is reflected from port 2 back to the test device. A portion of this wave may be re-reflected to port 2, or part may be transmitted through the device in the reverse direction to appear at port 1. If the DUT has low insertion loss (for example a transmission line), the signal reflected from port 2 and re-reflected from the source causes a significant error because the DUT does not attenuate the signal significantly on each reflection. Load match is usually given in terms of return loss in dB: thus the larger the number, the smaller the error.

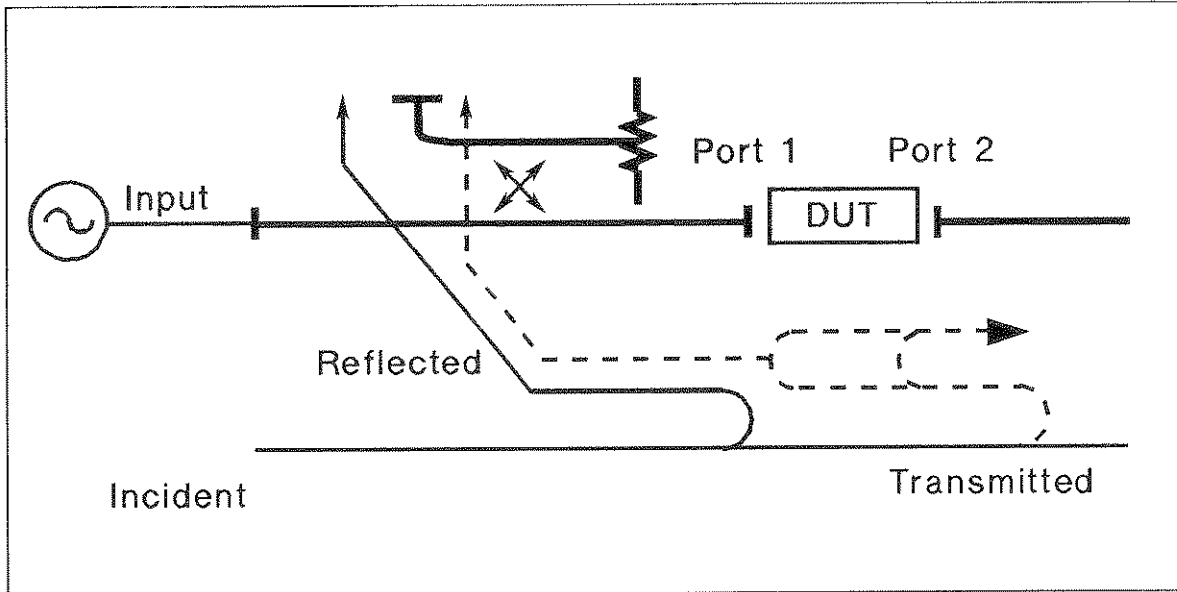

C2007044

Figure 7-3. Load Match

The error contributed by load match depends on the relationship between the actual output impedance of the test device and the effective match of the return port (port 2). It is a factor in all transmission measurements and in reflection measurements of two-port devices. Load match and source match are usually ignored when the test device insertion loss is greater than about 6 dB, because the error signal is greatly attenuated each time it passes through the DUT. However, load match effects produce major transmission measurement errors for a test device with a highly reflective output port.

Isolation (Crosstalk)

Leakage of energy between analyzer signal paths contributes to error in a transmission measurement much like directivity does in a reflection measurement. Isolation is the vector sum of signals appearing at the analyzer receivers due to crosstalk between the reference and test signal paths, including signal leakage within the test set and in both the RF and IF sections of the receiver.

The error contributed by isolation depends on the characteristics of the device under test. Isolation is a factor in high-loss transmission measurements. However, analyzer system isolation is more than sufficient for most measurements, and correction for it may be unnecessary. For measuring devices with high dynamic range, accuracy enhancement can provide improvements in isolation that are limited only by the noise floor.

Frequency Response (Tracking)

This is the vector sum of all test setup variations in which magnitude and phase change as a function of frequency. This includes variations contributed by signal separation devices, test cables, and adapters, and variations between the reference and test signal paths. This error is a factor in both transmission and reflection measurements.

For further explanation of systematic error terms and the way they are combined and represented graphically in error models, refer to the appendix at the end of this chapter, titled Accuracy Enhancement Fundamentals - Characterizing Systematic Errors.

CORRECTING FOR MEASUREMENT ERRORS

There are twelve different error terms for a two-port measurement that can be corrected by accuracy enhancement in the analyzer. These are directivity, source match, load match, isolation, reflection tracking, and transmission tracking, each in both the forward and reverse direction. The analyzer has several different measurement calibration routines to characterize one or more of the systematic error terms and remove their effects from the measured data. The procedures range from a simple frequency response calibration to a full two-port calibration that effectively removes all twelve error terms.

The **Response Calibration** effectively reduces the frequency response errors of the test setup for reflection or transmission measurements. This calibration procedure may be adequate for measurement of well matched low-loss devices. This is the simplest error correction to perform, and should be used when extreme measurement accuracy is not required.

The **Response and Isolation Calibration** effectively removes frequency response and crosstalk errors in transmission measurements, or frequency response and directivity errors in reflection measurements. This procedure may be adequate for measurement of well matched high-loss devices.

The **S₁₁ and S₂₂ One-Port Calibration** procedures provide directivity, source match, and frequency response vector error correction for reflection measurements. These procedures provide high accuracy reflection measurements of one-port devices or properly terminated two-port devices.

The **Full Two-Port Calibration** provides directivity, source match, load match, isolation, and frequency response vector error correction, in both forward and reverse directions, for transmission and reflection measurements of two-port devices. This calibration provides the best magnitude and phase measurement accuracy for both transmission and reflection measurements of two-port devices, and requires an S-parameter test set.

The **One-Path Two-Port Calibration** provides directivity, source match, load match, isolation, and frequency response vector error correction in one direction. It is used for high accuracy transmission and reflection measurements using a transmission/reflection test kit, such as the HP 87512A/B. (The device under test must be manually reversed between sweeps to accomplish measurements in both the forward and reverse directions.)

All the calibration procedures described above are accessed from the **CAL** key and are described in the following pages.

The uncorrected performance of the analyzer is sufficient for many measurements. However, the vector accuracy enhancement techniques described in this chapter will provide a much

higher level of accuracy. Figure 7-4, and Figure 7-5 illustrate the improvements that can be made in measurement accuracy by using a more complete calibration routine. Figure 7-4 shows a measurement in log magnitude format with a response calibration only, and the improvement in the same measurement using an S_{11} one-port calibration.

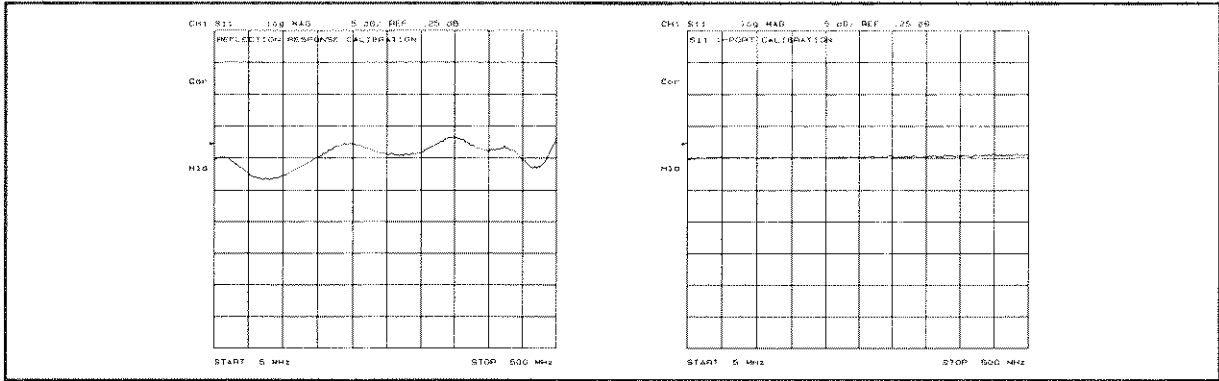

Figure 7-4. Response vs. S_{11} 1-Port Calibration on Log Magnitude Format

Figure 7-5 shows the response of a low-loss device in a log magnitude format, using a response calibration and a full two-port calibration.

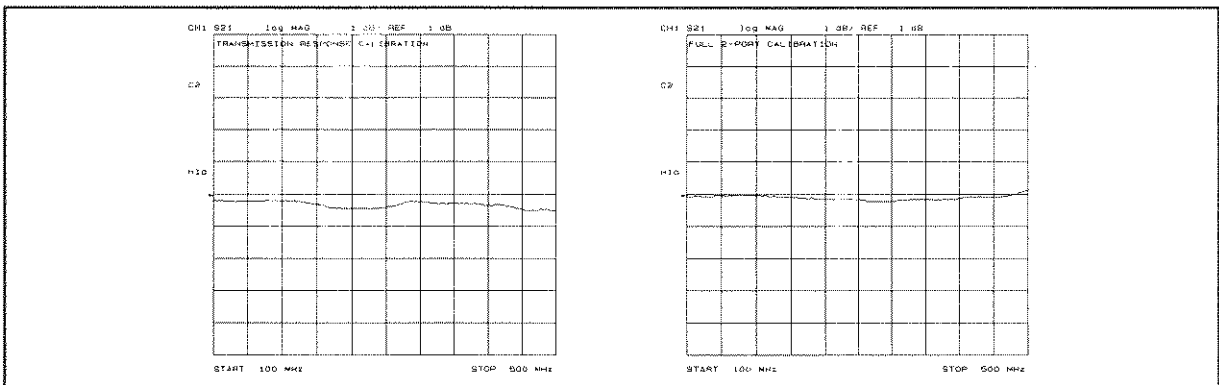
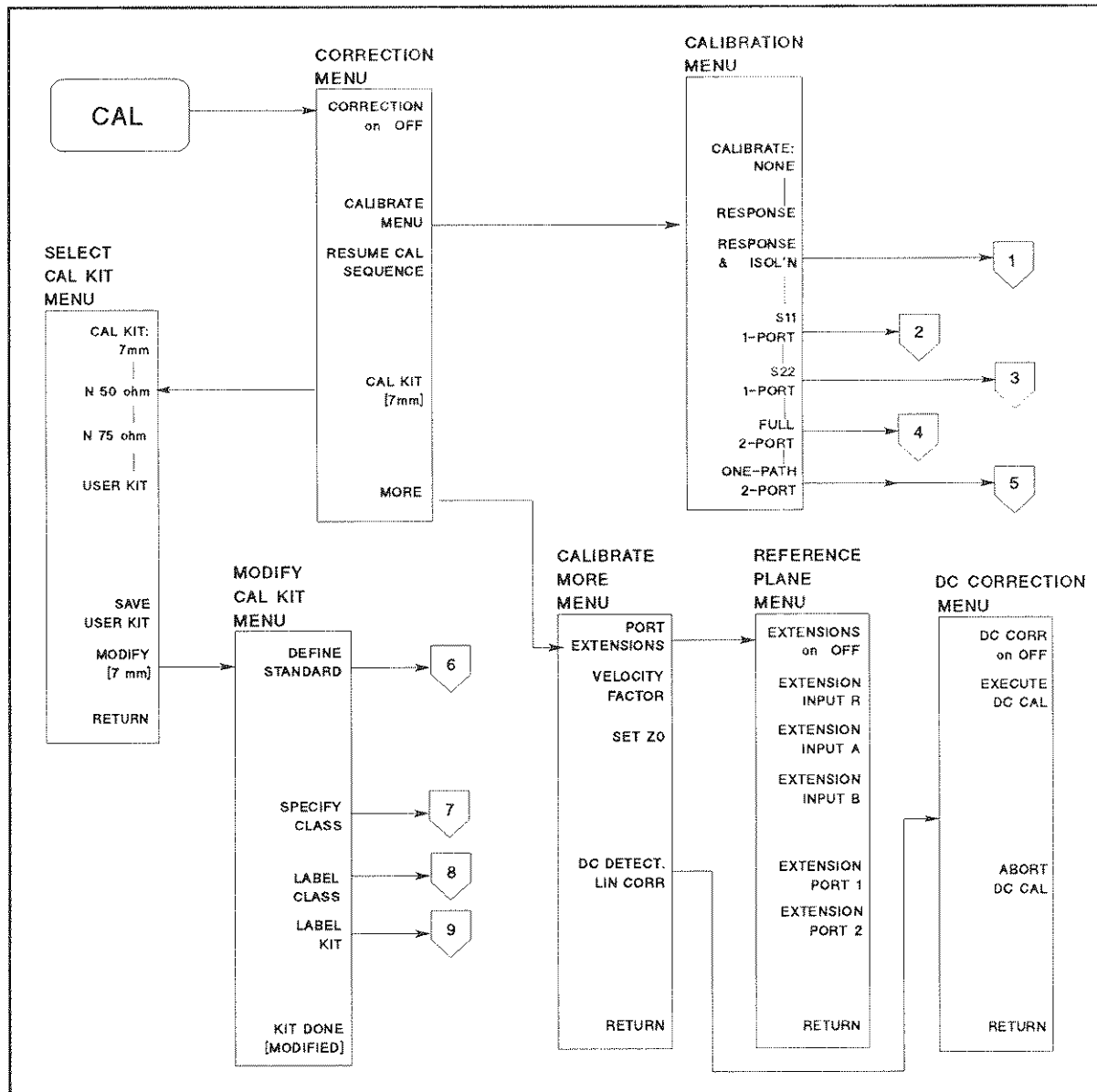

Figure 7-5. Response vs. Full Two-Port Calibration

After the correctable systematic errors are effectively removed using accuracy enhancement, residual uncertainties remain. In addition to random and drift errors, these include residual systematic errors resulting from imperfections in the calibration standards, the connector interface, the interconnecting cables, and the instrumentation.

MENUS AND SOFTKEYS

CAL Key



C2007013

Figure 7-6. Softkey Menus Accessed from the **CAL** Key

The HP-IB programming command is shown in parenthesis following the key or softkey. The **CAL** (KEY 15) key leads to a series of menus that implement the accuracy enhancement procedures described in the preceding pages (see Figure 7-6). Accuracy enhancement (error correction) is performed as a calibration step before measurement of a test device. The analyzer uses one of several different procedures to measure the systematic (repeatable) errors of the system and remove their effects from the measured data. The calibration menus and procedures are described and illustrated in the following pages. Each procedure compensates

7-8 Measurement Calibration

for one or more of the systematic error terms. These range from a simple response calibration that removes the frequency response errors of the test setup to a full two-port vector calibration that removes all twelve error terms. Measurements of standard devices solve for the error terms.

Standard Devices

The standard devices required for system calibration are available in compatible calibration kits with different connector types. The model numbers and contents of these calibration kits are listed in the General Information and Specifications section. Each kit contains at least one SHORT, one OPEN, and two impedance-matched LOADs. In kits that require adapters for interface to the test set ports, the adapters are phase-matched for calibration prior to measurement of non-insertable and non-reversible devices. Other standard devices can be used by specifying their characteristics in a user-defined kit, as described later in this chapter under “MODIFYING CALIBRATION KITS”.

The accuracy improvement of the correction is limited by the quality of the standard devices, and by the connection techniques used. For information about connector care and connection techniques, refer to *Application Note 326 Principles of Microwave Connector Care*. When possible, use a torque wrench for final connections. The techniques for torquing connections and the part numbers for torque wrenches recommended for different connector types are provided in the connector care documents mentioned above.

Interpolated Error Correction

The interpolated error correction feature allows the operator to change sweep range, or sweep type, without recalibration. Interpolation is activated automatically when one or more of these stimulus parameters is changed as listed in the following table.

- Sweep range is changed to fall inside of the calibrated range.
- Sweep type is changed.
- Number of points is changed.

When interpolation is ON, the system errors for the newly selected frequencies are calculated from the system errors of the original calibration.

Note There is no softkey to turn off interpolation.



Interpolated error correction functions in all sweep modes: linear frequency, log frequency, power sweep, and list sweep.

Channel Coupling

Up to four sets of measurement calibration data can be defined for each instrument state, one for each channel and each input port. (If two port full calibration is used, up to two sets of measurement calibration data can be defined, one for each channel.) If the two channels are stimulus coupled and the input ports are the same for both channels, they share the same calibration data. If the two channel inputs are different, they can have different calibration data. If the two channels are stimulus uncoupled, the measurement calibration applies to only one channel. For information on stimulus coupling, refer to Chapter 5.

Measurement Parameters

Calibration procedures are parameter-specific, rather than channel-specific. When a parameter is selected, the instrument checks the available calibration data, and uses the data found for that parameter. For example, if a transmission response calibration is performed for B/R, and an S_{11} 1-port calibration for A/R, the analyzer retains both calibration sets and corrects whichever parameter is displayed. Once a calibration has been performed for a specific parameter or input, measurements of that parameter remain calibrated in either channel (as long as stimulus values are coupled). In the response and response and isolation calibrations, the parameter must be selected before calibration; other correction procedures select parameters automatically. Changing channels during a calibration procedure invalidates the part of the procedure already performed.

Device Measurements

In procedures that require measurement of several different devices, for example a SHORT, an OPEN, and a LOAD, the order in which the devices are measured is not critical. Any standard can be re-measured, until the **DONE** key is pressed. The change in trace during measurement of a standard is normal.

Response and response and isolation calibrations require measurement of only one standard device. If more than one device is measured, only the data for the last device is retained.

Omitting Isolation Calibration

Isolation calibration can be omitted for most measurements, except where wide dynamic range is a consideration. Use the following guidelines. When the measurement requires a dynamic range of:

- under 80 dB: Omit isolation calibration for most measurements.
- 80 to 100 dB: Isolation calibration is recommended with approximately 0 dBm into the R input.
- over 100 dB: Averaging should be ON with an averaging factor ≥ 16 , both for isolation calibration and for measurement after calibration.

Stopping During the Calibration Procedure

You can stop at any point during a calibration procedure, without losing the steps you have already performed. No special steps are necessary to leave; just do whatever task you want. To continue the calibration where you left off, press **CAL RESUME CAL SEQUENCE**.

Saving Calibration Data

It is recommended that calibration data be saved on a built-in disk. Refer to Chapter 11. If a calibration is not saved, it will be lost if another calibration procedure is selected for the same channel. Instrument preset, power on, and instrument state recall will also clear the calibration data.

Specifying Calibration Kits

In addition to the menus for the different calibration procedures, the **CAL** key provides access to a series of menus used to specify the characteristics of the calibration standards used. Hewlett-Packard calibration kits are predefined, or the definitions can be modified to any set of standards used.

Correction Menu

The correction menu is the first menu presented by the **CAL** key, and it provides access to numerous menus of additional calibration features.

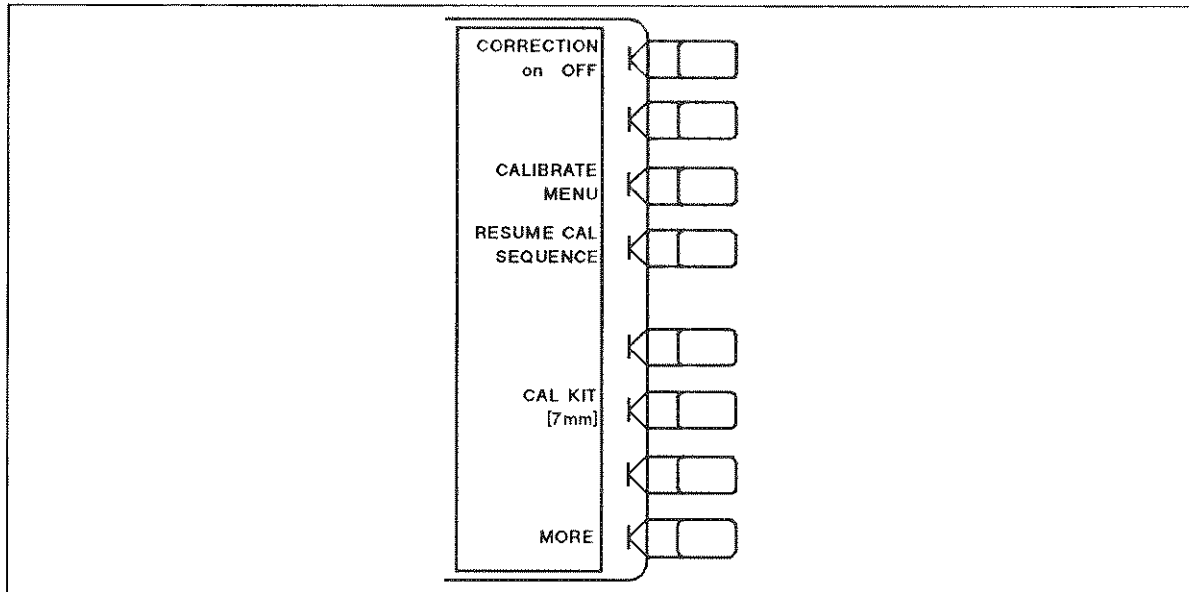

Figure 7-7. Correction Menu

CORRECTION on OFF (CORRON, CORROFF) turns error correction ON or OFF. The analyzer uses the most recent calibration data for the displayed parameter.

If one of the next stimulus parameters has been changed, correction is automatically turned OFF.

- Input measurement port is changed.
- Calibration type is changed.

If one of the next stimulus parameters has been changed, interpolated correction is automatically turned on and the status notation is changed to "C?" or "C2?" (refer to "CRT DISPLAY" in Chapter 2).

- Sweep range is changed to fall inside of the calibrated range.
- Sweep type is changed.
- Number of Point is changed.

If one of the next stimulus parameters has been changed, the status notation is changed to "C!" or "C2!" (refer to "CRT DISPLAY" in Chapter 2). In this status, error corrections at a stimulus point will be done using calibration coefficient at the nearest calibrated frequency point, or the CW frequency.

- Sweep range is changed so both start and stop, or one of the start and stop stimulus value are/is out the calibrated range.
- Sweep type is changed to or from power sweep. (If span is zero and measurement frequency is equal to CW frequency of power sweep, the status is not changed.)

A calibration must be performed before correction can be turned ON. If no valid calibration exists, the message "CALIBRATION REQUIRED" is displayed on the display.

It is recommended that calibration data be saved on the built-in disk, using the capabilities described in Chapter 11.

CALIBRATE MENU leads to the calibration menu, which provides several accuracy enhancement procedures ranging from a simple frequency response calibration to a full two-port calibration. At the completion of a calibration procedure, correction is automatically turned ON, and the notation "Cor" or "C2" is displayed at the left of the screen.

RESUME CAL SEQUENCE (RESC) eliminates the need to restart a calibration sequence that was interrupted to access some other menu. This softkey goes back to the point where the calibration sequence was interrupted.

CAL KIT leads to the select cal kit menu, which selects one of the default calibration kits available for different connector types. This in turn leads to additional menus used to define calibration standards other than those in the default kits (refer to "MODIFYING CALIBRATION KITS", later in this chapter). When a calibration kit has been specified, its connector type is displayed in brackets in the softkey label.

MORE provides access to the calibrate more menu, which extends the test port reference plane, to specify the characteristic impedance of the system, the relative propagation velocity factor, and DC linearity correction.

Select Cal Kit Menu

This selects the calibration kit for a measurement calibration. Selecting a cal kit chooses the model that mathematically describes the standard devices actually used. Refer to the beginning of this chapter, and the appendix at the end of this chapter, for more background on measurement calibrations and error correction.

The analyzer has the capability to calibrate with three predefined cal kits in four different connector types. The models for these cal kits correspond to the standard calibration kits available as accessories:

- 7 mm HP 85031B 7 mm calibration kit
- 50 Ω Type-N HP 85032B 50 Ω type-N calibration kit
- 75 Ω Type-N HP 85036B 75 Ω type-N calibration kit

Cal kits other than those listed can be used. For example: The errors introduced by using the internal 7 mm model with a Hewlett-Packard 7 mm cal kit other than the HP 85031B are very small. For the highest accuracy, the more closely the model matches the device, the better.

In addition to the three predefined cal kits, a fourth choice is a "user kit" that is defined or modified by the user. This is described under "MODIFYING CALIBRATION KITS" later in this chapter.

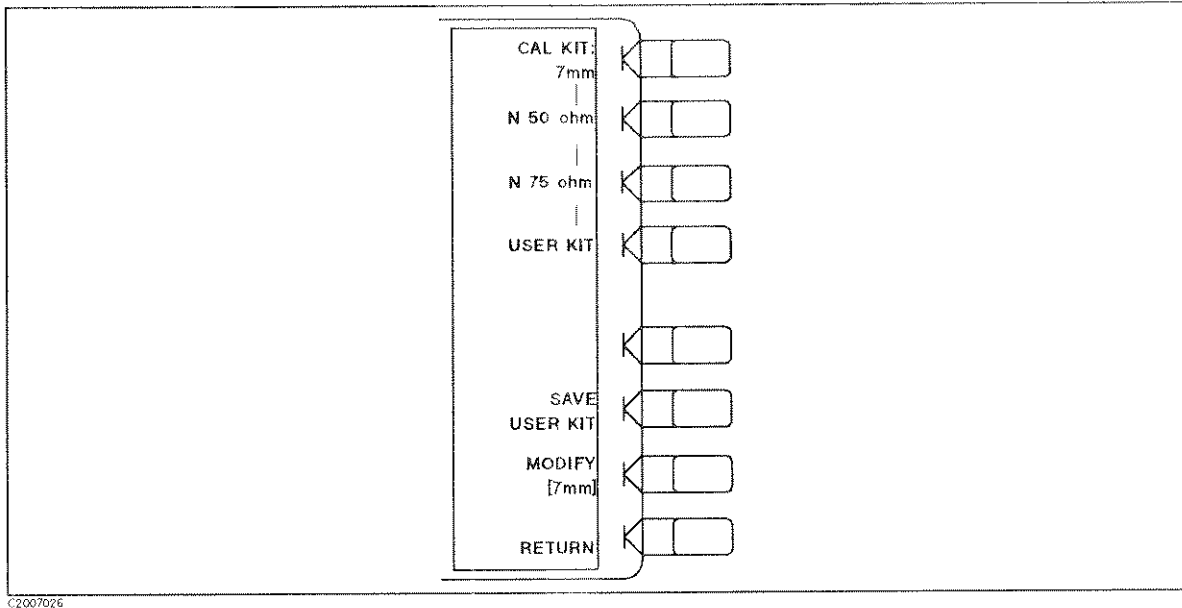

C2007026

Figure 7-8. Select Cal Kit Menu

CAL KIT: 7mm (CALK7MM) selects the 7 mm cal kit model.

N 50Ω (CALKN50) selects the 50 Ω type-N model.

N 75Ω (CALKN75) selects the 75 Ω type-N model.

Note



If **N 50Ω** or **N 75Ω** is selected, additional menus are provided during calibration procedures to select the connector sex. This is the connector sex of the input port, not the actual calibration standard.

USER KIT (CALKUSED) selects a cal kit model defined or modified by the user. For information, refer to “MODIFYING CALIBRATION KITS”, later in this chapter.

SAVE USER KIT (SAVEUSEK) stores the user-modified or user-defined kit into memory, after it has been modified.

MODIFY (MODI1) leads to the modify cal kit menu, where a default cal kit can be user-modified.

RETURN returns to the correction menu.

Calibrate More Menu

This menu extends the test port reference plane, specifies the characteristic impedance of the system, and specifies the relative propagation velocity factor.

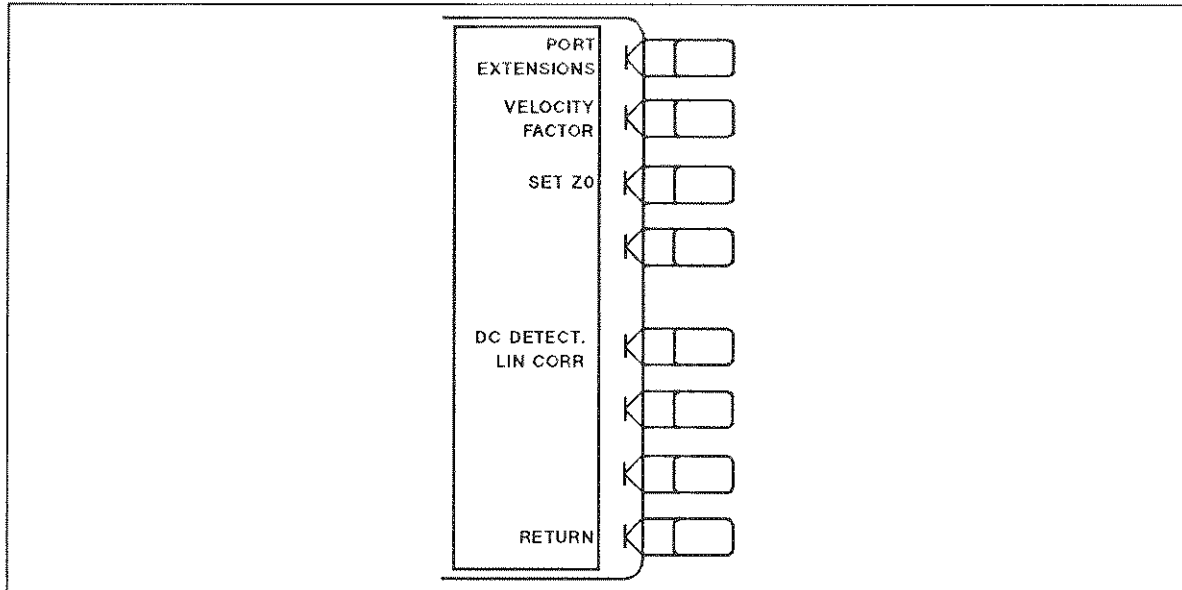

C2007040

Figure 7-9. Calibrate More Menu

PORT EXTENSIONS goes to the reference plane menu, which extends the apparent location of the measurement reference plane or input.

The differences between the **PORT EXTENSIONS** and **ELECTRICAL DELAY** functions are described in the following table.

Table 7-1. Differences between **PORT EXTENSIONS** and **ELECTRICAL DELAY**

	PORT EXTENSIONS	ELECTRICAL DELAY
Main Effect	The end of a cable becomes the test port plane for all S-parameter measurements.	Compensates for the electrical length of a cable for the current type of measurement only. Reflection = 2 times cable's electrical length. Transmission = 1 times cable's electrical length.
Measurements Affected	All S-parameters.	Only the currently selected measurement parameter.
Electrical Compensation	Intelligently compensates for 1 times or 2 times the cable's electrical delay, depending on which S-parameter is computed.	Only compensates as necessary for the currently selected measurement parameter.

VELOCITY FACTOR (VELOFACT) Enters the velocity factor used by the analyzer to calculate equivalent electrical length. Values entered should be less than 1. For example, the velocity factor of Teflon is:

$$V_f = \frac{1}{\sqrt{\epsilon_R}}$$

$$= 0.666$$

SET Z0 (SETZ) sets the characteristic impedance used by the analyzer in calculating measured impedance with Smith chart markers and conversion parameters. If the test set used is an HP 87511B S-parameter test set or an HP 87512B Transmission/Reflection Test Kit, set Z_0 to 75 Ω . Characteristic impedance must be set correctly before calibration procedures are performed.

DC DETECT. LIN CORR provides the DC correction menu, which calibrates an external DC voltage detector in the Bdc or Bdc/R measurements.

RETURN goes back to the correction menu.

Reference Plane Menu

This adds electrical delay in seconds to the measurement ports to extend the apparent location of the measurement reference plane to the ends of the cables. This is equivalent to adding a length of perfect air line, and makes it possible to measure the delay response of the DUT only, instead of the DUT plus the adapter, cable, or other incidental device. Read the previous description of Port Extension for more information.

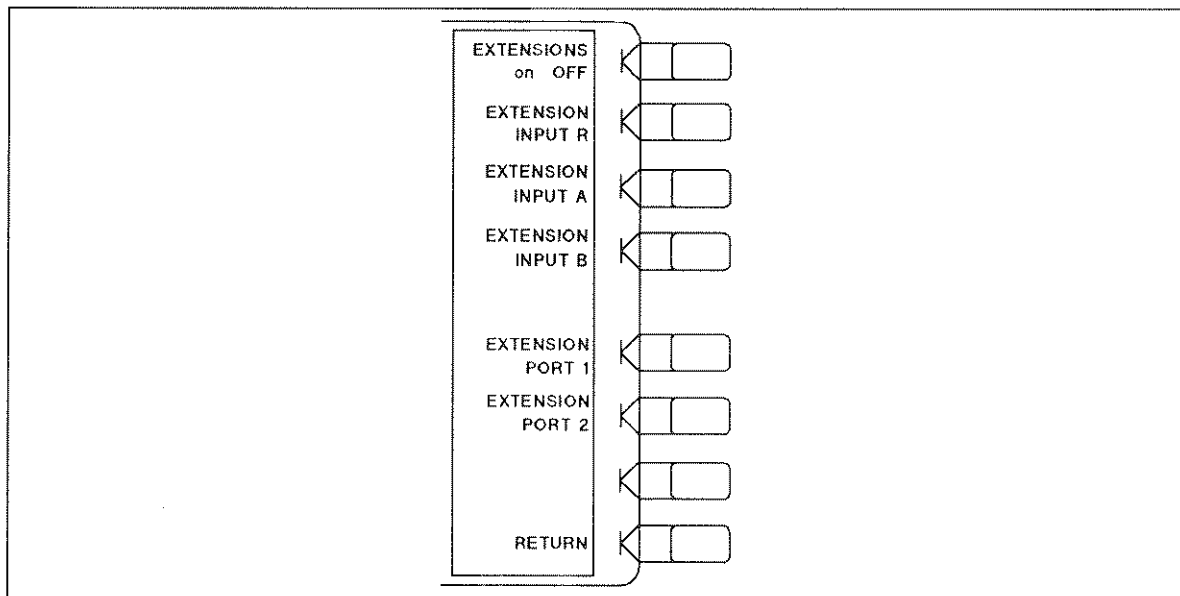

Figure 7-10. Reference Plane Menu

EXTENSIONS on OFF (POREON, POREOFF) toggles the reference plane extension mode. When this function is ON, all extensions defined below are enabled; when OFF, none of the extensions is enabled.

EXTENSION INPUT R (PORTR) adds electrical delay in seconds to extend the reference plane at input R to the end of the cable. This is used for any R input measurements including S-parameters.

EXTENSION INPUT A (PORTA) adds electrical delay to the input A reference plane for any A input measurements including S-parameters.

EXTENSION INPUT B (PORTB) adds electrical delay to the input B reference plane for any B input measurements including S-parameters.

EXTENSION PORT 1 (PORT1) extends the reference plane for measurements of S_{11} , S_{21} , and S_{12} .

EXTENSION PORT 2 (PORT2) extends the reference plane for measurements of S_{22} , S_{12} , and S_{21} .

RETURN goes back to the calibrate more menu.

DC Correction Menu

This calibrates an external DC detector's output voltage linearity for the Bdc or Bdc/R measurements. When the calibration starts, the analyzer sweeps its output power from -50 dBm to $+15$ dBm to obtain the detector's response. After the sweep ends, the calibration data for the detector's non-linearity is calculated and stored to non volatile memory.

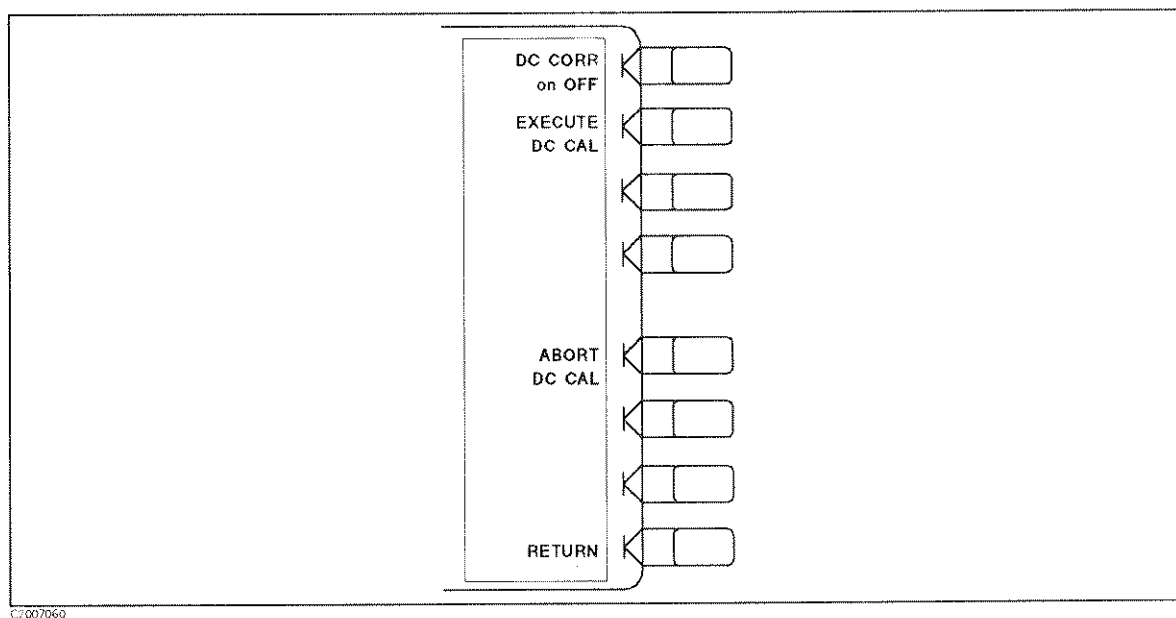

Figure 7-11. DC Correction Menu

DC CORR on OFF (DCCORON, DCCOROFF) turns error correction ON or OFF. The analyzer uses the most recent calibration data.

EXECUTE DC CAL (EXEDCALI) starts calibration. The calibration is performed by sweeping the output power from -50 dBm to $+15$ dBm. The swept signal's frequency is set by the **CW FREQ** described in "Stimulus Menu" in Chapter 5.

Note Any frequency response of the detector can be calibrated.



Caution Make sure the detector is capable of +15 dBm input at the calibrating frequency.



After the calibration is done, the calibration data is calculated and stored. The sweep parameter will be the power sweep, regardless of the prior sweep parameter.

ABORT DC CAL (ABODCALI) aborts the calibration.

RETURN returns to the Calibrate More Menu.

Calibration Menu

This selects the type of measurement calibration you wish to perform. Six different calibration routines are available, each of which effectively removes from one to twelve systematic errors from the measurement data. Each calibration procedure features display prompts to guide you through the calibration sequence. The available calibrations are described below, and a comparative summary is provided in Table 7-2. Procedures for performing each of the calibrations are provided in the following pages, together with illustrations of the corresponding menus.

Note that all instrument parameters should be established before a calibration procedure is started, including stimulus values, calibration kit, and system characteristic impedance Z_0 (To modify the characteristic impedance, refer to “Calibrate More Menu”). You may choose a subset of the full frequency range, or a different sweep type, using the interpolated error correction, after the system has been calibrated. (Refer to “Interpolated Error Correction” and “Correction Menu” in this Chapter.) The performance of interpolated error correction is not specified.

Note By convention, when the connector sex is provided in parentheses for a calibration standard, it refers to the sex of the test port connector, not the sex of the standard. For example, “SHORT [m]” indicates that the test port connector is male, not the SHORT connector.



Note The compatible type-N calibration kits for the analyzer provide OPENs with center conductor extenders. For maximum accuracy in calibration with these devices, follow these steps:



1. Connect the outer conductor by hand and tighten with a torque wrench.
2. Insert the center conductor extender into the outer conductor. The fit should be snug but free.
3. Push gently until the center conductors mate.

For measurement of test devices following calibration, refer to *the User's Guide*.

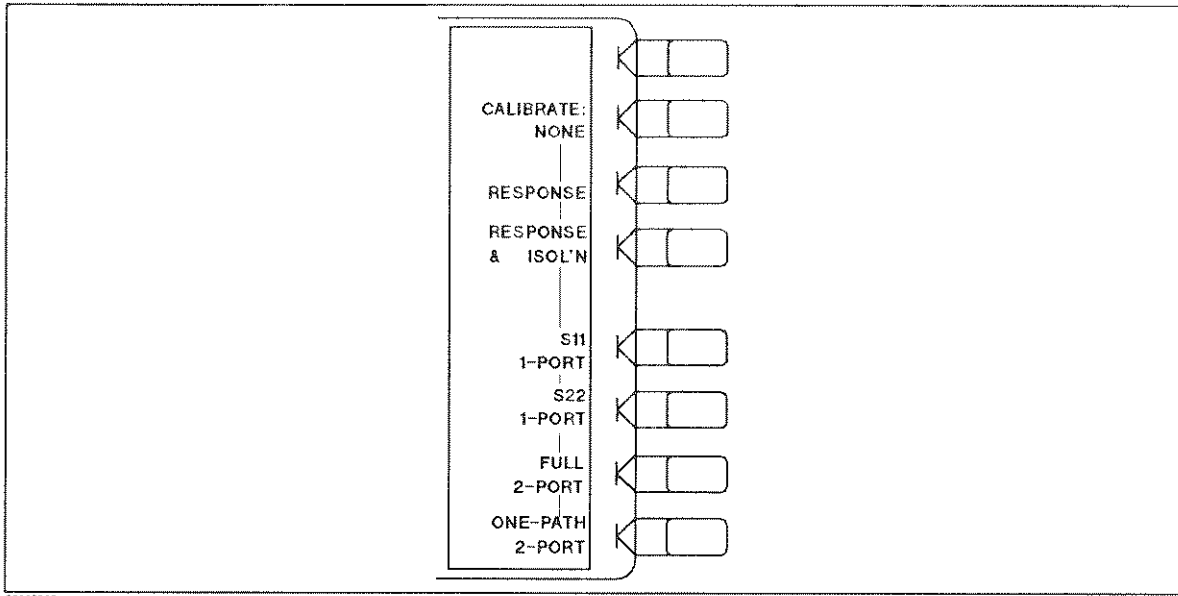

Figure 7-12. Calibration Menu

CALIBRATE: NONE (CALN) is underlined if no calibration has been performed or if the calibration data has been cleared. Unless a calibration is saved on the internal disk, the calibration data is lost on instrument preset, power ON, or instrument state recall.

RESPONSE (CALIRESP) leads to the frequency response calibration. This is the simplest and fastest accuracy enhancement procedure, but should be used when extreme accuracy is not required. It effectively removes the frequency response errors of the test setup for reflection or transmission measurements.

For transmission-only measurements or reflection-only measurements, only a single calibration standard is required with this procedure. The standard for transmission measurements is a THRU, and for reflection measurements can be either an OPEN or a SHORT. If more than one device is measured, only the data for the last device is retained. The procedures for response calibration for a reflection measurement and a transmission measurement are described in the following pages.

RESPONSE & ISOL'N (CALIRAI) leads to the menus used to perform a response and isolation measurement calibration, for measurement of devices with wide dynamic range. This procedure effectively reduces the same errors as the response calibration. In addition, it effectively reduces the isolation (crosstalk) error in transmission measurements or the directivity error in reflection measurements. As well as the devices required for a simple response calibration, an isolation standard is required. The standard normally used to correct for isolation is an impedance-matched LOAD (usually 50 or 75 Ω). Response and directivity calibration procedures for reflection and transmission measurements are provided in the following pages.

S11 1-PORT (CALIS111) provides a measurement calibration for reflection-only measurements of one-port devices or properly terminated two-port devices, at port 1 of an S-parameter test set or the test port of a transmission/reflection test kit. This procedure effectively reduces the directivity, source match, and frequency response errors of the test setup, and provides a higher level of measurement accuracy than the response and isolation calibration. It is the

most accurate calibration procedure for reflection-only measurements. Three standard devices are required: a SHORT, an OPEN, and an impedance-matched LOAD. The procedure for performing an S_{11} one-port calibration is described in the following pages.

S22 1-PORT (CALIS221) is similar to S_{11} 1-PORT. It is used for reflection-only measurements of one-port devices or properly terminated two-port devices in the reverse direction: that is, for devices connected to port 2 of the S-parameter test set.

FULL 2-PORT (CALIFUL2) leads to the series of menus used to perform a complete calibration for measurement of all four S-parameters of a two-port device. This is the most accurate calibration for measurements of two-port devices. It effectively reduces all correctable systematic errors (directivity, source match, load match, isolation, reflection tracking, and transmission tracking) in both the forward and the reverse direction. Isolation correction can be omitted for measurements of devices with limited dynamic range.

The standards for this procedure are a SHORT, an OPEN, a THRU, and an impedance-matched LOAD (two LOADs if isolation correction is required). An S-parameter test set is required. The procedure is described in the following pages.

ONE-PATH 2-PORT (CALIONE2) leads to the series of menus used to perform a high-accuracy two-port calibration without an S-parameter test set. This calibration procedure effectively reduces directivity, source match, load match, isolation, reflection tracking, and transmission tracking errors in one direction only. Isolation correction can be omitted for measurements of devices with limited dynamic range. (The device under test must be manually reversed between sweeps to accomplish measurement of both input and output responses.) The required standards are a SHORT, an OPEN, a THRU, and an impedance-matched LOAD. The procedure for performing a one-path 2-port calibration is described in the following pages.

Table 7-2. Purpose and Use of Different Calibration Procedures

Calibration Procedure	Corresponding Measurement	Errors Reduced	Standard Devices
Response	Transmission or reflection measurement when the highest accuracy is not required.	Freq. response	THRU for trans., OPEN or SHORT for reflection
Response & isolation	Transmission of high insertion loss devices or reflection of high return loss devices. Not as accurate as 1-port or 2-port calibration.	Freq. response plus isolation in transmission or directivity in reflection	Same as response plus isolation std (LOAD)
S_{11} 1-port	Reflection of any one-port device or well terminated two-port device.	Directivity, source match, freq. response.	SHORT and OPEN and LOAD
S_{22} 1-port	Reflection of any one-port device or well terminated two-port device.	Directivity, source match, freq. response.	SHORT and OPEN and LOAD
Full 2-port	Transmission or reflection of highest accuracy for two-port devices. HP 87511A/B S-parameter Test Set is required.	Directivity, source match, load match, isolation, freq. response, forward and reverse.	SHORT and OPEN and LOAD and THRU (2 LOADs for isolation)
One-path 2-port	Transmission or reflection of highest accuracy for two-port devices. (Reverse test device between forward and reverse measurements.)	Directivity, source match, load match, isolation, freq. response, forward direction only.	SHORT and OPEN and LOAD and THRU

Response Calibration for Reflection Measurements

This performs a frequency response only calibration with an S-parameter test set for a measurement of S_{11} . (Refer to Figure 7-13.) It can also be used for S_{22} by substituting the corresponding softkey in the S-parameters menu.

A similar procedure can be performed with a transmission/reflection test kit, using the input ports menu instead of the S-parameters menu (described in Chapter 6).

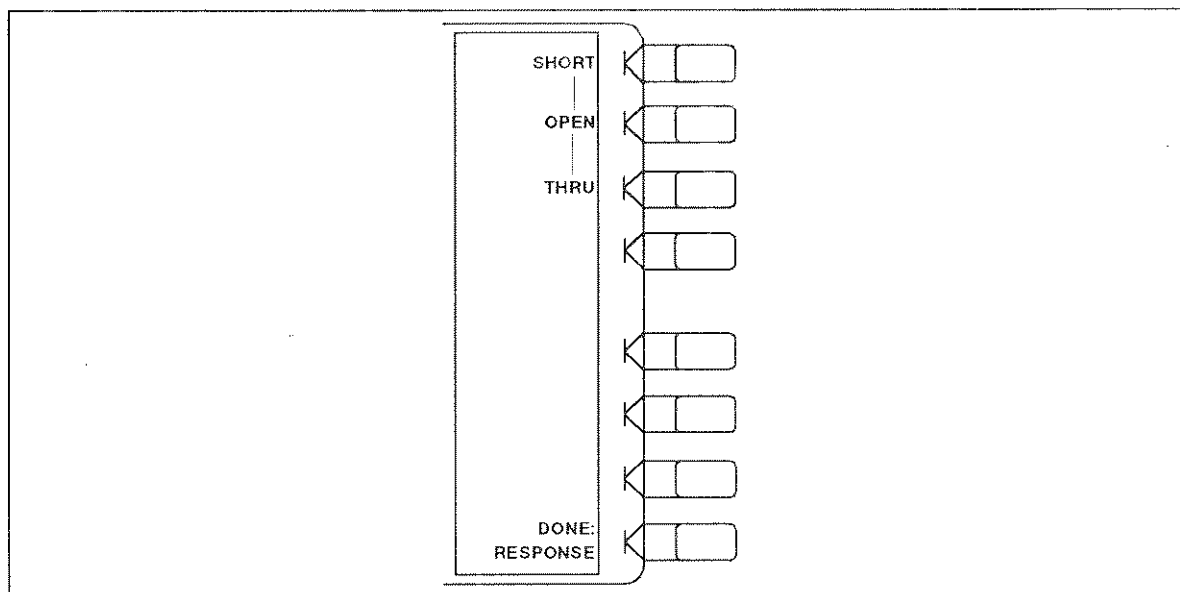

Figure 7-13. Response Cal Menu

Procedure

1. Press **MEAS** Ref1: **FWD S11 A/R**.
2. Press **CAL**.
3. Select the proper calibration kit. If the connector type or cal kit name shown in the **CAL KIT** softkey label is not the same as the calibration kit to be used, refer to “Select Cal Kit Menu”.
4. Press **CALIBRATE MENU RESPONSE**.
5. At port 1, connect either a **SHORT** or a shielded **OPEN**.
6. When the trace settles, press **SHORT** or **OPEN**, depending on the standard used. If more than one device is measured, only the data for the last device is retained.
7. The message “**WAIT - MEASURING CAL STANDARD**” is displayed while the data is measured. The softkey label **SHORT** or **OPEN** is then underlined.
8. Press **DONE: RESPONSE** to complete the calibration. The error coefficients are computed and stored. The correction menu is displayed with **CORRECTION ON**. A corrected trace is displayed.

Now the test device can be connected and measured. It is recommended that calibration data be saved using the built-in disk drive. Refer to Chapter 11.

Response Calibration for Transmission Measurements

This performs a frequency response only calibration with an S-parameter test set for a measurement of S_{21} . (Refer to Figure 7-13.) To calibrate for a combined transmission and reflection measurement, perform the transmission calibration on one channel and the reflection calibration described above on the other channel.

A similar procedure can be performed with a transmission/reflection test kit, using the input ports menu instead of the S-parameters menu (see Chapter 6).

Procedure

1. Press **MEAS** Trans: FWD S21 B/R.
2. Press **CAL**.
3. Select the proper calibration kit. If the connector type or cal kit name shown in the **CAL KIT** softkey label is not the same as the calibration kit to be used, refer to "Select Cal Kit Menu".
4. Press **CALIBRATE MENU RESPONSE**.
5. Connect a THRU (connect together the points at which the test device will be connected).
6. When the trace settles, press **THRU**.
7. The message "WAIT - MEASURING CAL STANDARD" is displayed while the S_{21} data is measured. The softkey label **THRU** is then underlined.
8. Press **DONE: RESPONSE** to complete the calibration. The error coefficients are computed and stored. The correction menu is displayed with **CORRECTION ON**. Corrected S_{21} data is displayed.

Now the test device can be connected and measured. It is recommended that calibration data be saved using the built-in disk drive. Refer to Chapter 11.

Response and Isolation Calibration for Reflection Measurements

This effectively reduces the frequency response and directivity errors for reflection measurements. The menus illustrated in Figure 7-14 perform a calibration with an S-parameter test set for a measurement of S_{11} . It can also be used for S_{22} by substituting the corresponding softkey in the S-parameters menu.

A similar procedure can be performed with a transmission/reflection test kit, using the input ports menu instead of the S-parameters menu (described in Chapter 6).

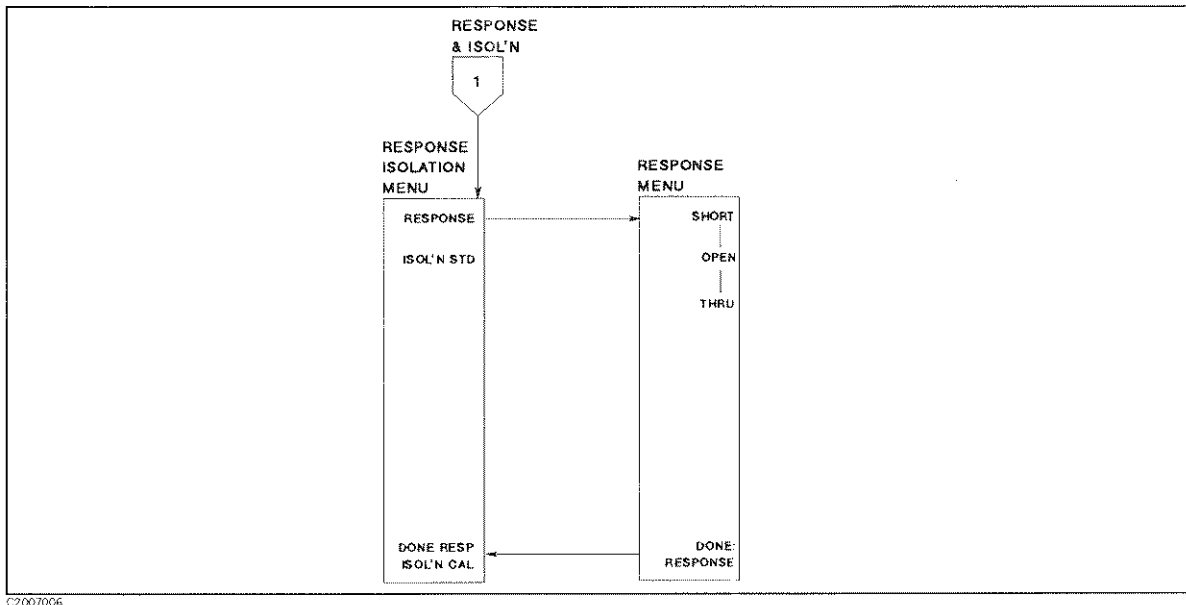

Figure 7-14. Response and Isolation Cal Menu and Response Cal Menu

Procedure

1. Press **MEAS** Refl: FWD S11 A/R.
2. Press **CAL**.
3. Select the proper calibration kit. If the connector type or cal kit name shown in the **CAL KIT** softkey label is not the same as the calibration kit to be used, refer to "Select Cal Kit Menu".
4. Press **CALIBRATE MENU RESPONSE & ISOL'N RESPONSE**.
5. At port 1, connect either a **SHORT** or a shielded **OPEN**.
6. When the trace settles, press **SHORT** or **OPEN**, depending on the standard used. If more than one standard is measured, only the data for the last device is retained.
7. The message "WAIT - MEASURING CAL STANDARD" is displayed while the response data is measured. The softkey label **SHORT** or **OPEN** is then underlined.
8. Press **DONE: RESPONSE**. The error coefficients are computed and stored. The response and isolation menu is displayed.
9. Connect the isolation standard to port 1. This is an impedance-matched LOAD (usually 50 or 75 Ω).
10. Press **ISOL'N STD**. The S_{11} isolation data is measured. The softkey label is underlined.

11. Press **DONE RESP ISOL'N CAL** to complete the calibration. The directivity error coefficients are computed and stored. The correction menu is displayed with **CORRECTION ON**. A corrected trace is displayed.

Now the test device can be connected and measured. It is recommended that calibration data be saved on a built-in disk. Refer to Chapter 11.

Response and Isolation Calibration for Transmission Measurements

This effectively reduces the frequency response and isolation errors for transmission measurements of devices with wide dynamic range, using the menus illustrated in Figure 7-14. To calibrate for a combined transmission and reflection measurement, perform the transmission calibration on one channel and the reflection calibration described above on the other channel.

This procedure uses an S-parameter test set. A similar procedure can be performed with a transmission/reflection test kit, using the input ports menu instead of the S-parameters menu (see Chapter 6).

Procedure

1. Press **MEAS** **Trans: FWD S21 B/R**.
2. Press **CAL**.
3. Select the proper calibration kit. If the connector type or cal kit name shown in the **CAL KIT** softkey label is not the same as the calibration kit to be used, refer to "Select Cal Kit Menu".
4. Press **CALIBRATE MENU RESPONSE & ISOL'N RESPONSE**.
5. Connect a THRU between port 1 and port 2 at the points where the test device will be connected.
6. When the trace has settled, press **THRU**. S_{21} response data is measured. The softkey label **THRU** is underlined.
7. Press **DONE: RESPONSE**.
8. Connect impedance-matched LOADs to port 1 and port 2. Press **ISOL'N STD**. The S_{21} isolation data is measured. The softkey label is underlined.
9. Press **DONE RESP ISOL'N CAL** to complete the calibration. The S_{21} error coefficients are computed and stored. The correction menu is displayed with **CORRECTION ON**. Corrected S_{21} data is displayed and the notation "Cor" at the left of the screen indicates that correction is ON for this channel.

A similar procedure calibrates for measurement of S_{12} , using the **Trans: REV S12 B/R** softkey in the S-parameters menu.

It is recommended that calibration data be saved on a built-in disk. Refer to Chapter 11.

S₁₁ 1-Port Calibration for Reflection Measurements

This performs a complete vector error correction for reflection measurements of one-port devices or properly terminated two-port devices. (Refer to Figure 7-15.) This is a high-accuracy calibration that effectively reduces the directivity, source match, and frequency response errors from the measured data. The calibration described here uses an S-parameter test set: a similar procedure can be performed with a transmission/reflection test kit, using the input ports menu instead of the S-parameters menu described in Chapter 6.

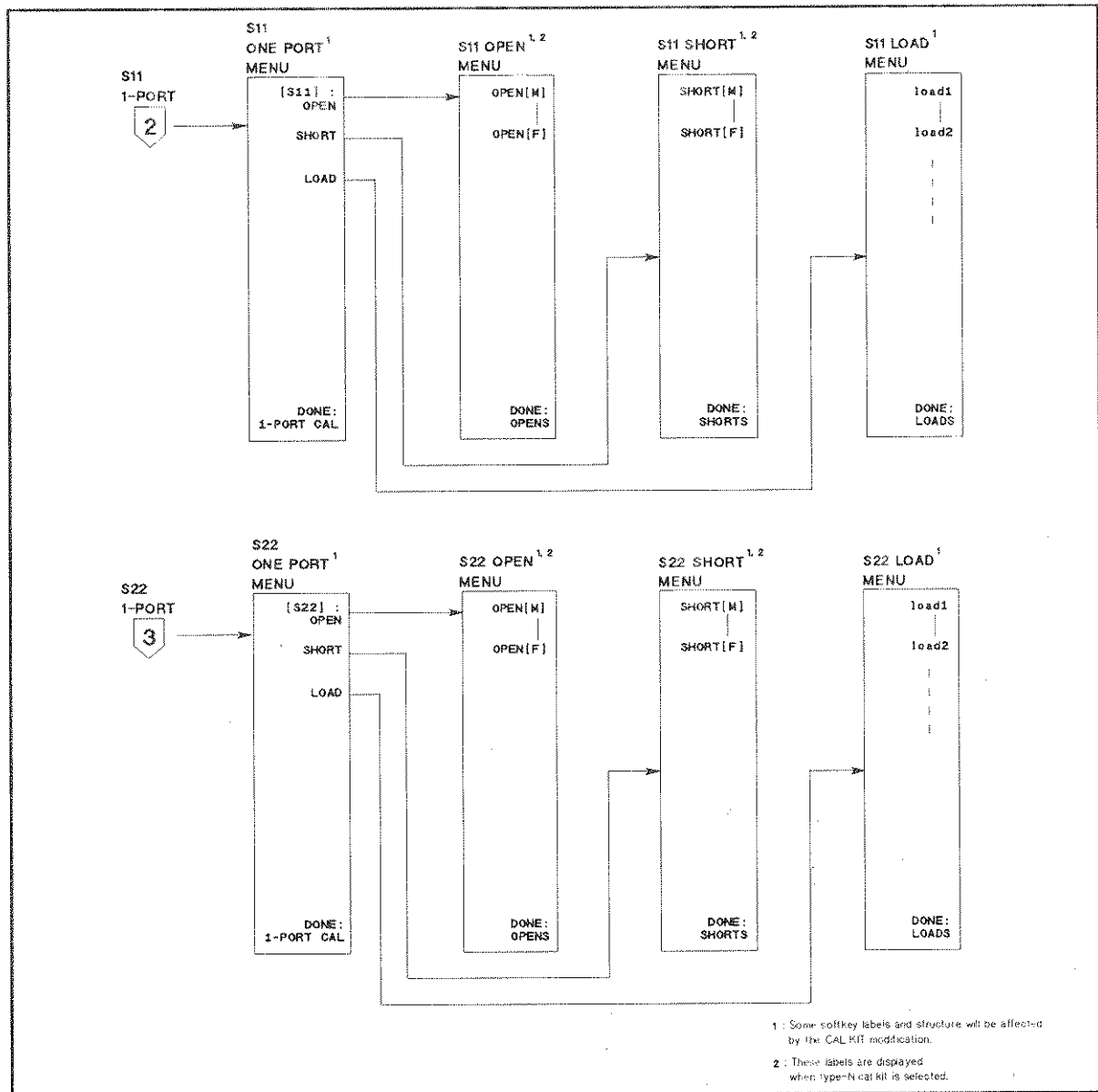

Figure 7-15. S₁₁ and S₂₂ 1-Port Cal Menus

Procedure

1. Press **CAL**.
2. Select the proper calibration kit. If the connector type or cal kit name shown in the **CAL KIT** softkey label is not the same as the calibration kit to be used, refer to "Select Cal Kit Menu".
3. Press **CALIBRATE MENU S11 1-PORT**.
4. Connect a shielded **OPEN** to port 1.
5. When the trace settles, press **(S11):OPEN** (for the 7 mm cal kit) or **(S11):OPENS** (for the type-N cal kit).
6. When the 7 mm cal kit is selected in step 2, the message "WAIT - MEASURING CAL STANDARD" is displayed while the **OPEN** data is measured. The softkey label **OPEN** is then underlined.

When the type-N cal kit is selected in step 2, the **OPEN [M]** and **OPEN [F]** softkeys are displayed. Press **OPEN [M]** (for male port connector) or press **OPEN [F]** (for female port connector). The message "WAIT - MEASURING CAL STANDARD" is displayed while the **OPEN** data is measured. The softkey label is then underlined.

7. Disconnect the **OPEN**, and connect a **SHORT** to port 1.
8. When the trace settles, press **SHORT** (for the 7 mm cal kit) or **SHORTS** (for the type-N cal kit).
9. When the 7 mm cal kit is selected in step 2, the **SHORT** data is measured and the softkey label is underlined.

When the type-N cal kit is selected in step 2, the **SHORT [M]** and **SHORT [F]** softkeys are displayed. Press **SHORT [M]** (for male port connector) or press **SHORT [F]** (for female port connector). The **SHORT** data is measured and the softkey label is then underlined.

10. Disconnect the **SHORT**, and connect an impedance-matched **LOAD** (usually 50 or 75 Ω) at port 1.
11. When the trace settles, press **LOAD**. The **LOAD** data is measured and the softkey label is underlined.
12. Press **DONE 1-PORT CAL** to complete the calibration. (If you press **DONE** without measuring all the required standards, the message "CAUTION: ADDITIONAL STANDARDS NEEDED" will be displayed.) The error coefficients are computed, and the correction menu is returned to the screen with **CORRECTION ON**. A corrected **S11** trace is displayed, and the notation "Cor" appears at the left side of the screen.

The test device can now be connected and measured. It is recommended that calibration data be saved on a built-in disk. Refer to Chapter 11.

S22 1-Port Calibration

This performs a complete vector error correction for a reverse reflection measurement of a one-port device or a properly terminated two-port device. It is similar to the **S11** 1-port calibration except that **S22** is selected automatically.

This calibration is used only with an S-parameter test set. For S-parameter measurements in the reverse direction with a transmission/reflection test kit use the **S11** 1-port or one-path 2-port calibration and reverse the device under test between measurement sweeps.

Full 2-Port Calibration for Reflection and Transmission Measurements

This performs complete vector error correction for measurement of all four S-parameters. (Refer to Figure 7-16.) This is the most accurate calibration for measurements of two-port devices, and effectively reduces all correctable systematic errors in both the forward and reverse directions.

An S-parameter test set is required for this calibration. The procedure automatically switches the test set to select the appropriate S-parameter at each step. A similar two-port procedure can be performed with a transmission/reflection test kit using the one-path 2-port calibration.

To extend the life of the mechanical transfer switch in the HP 87511A/B S-parameter Test Sets, switching occurs only once in a measurement sequence using full two-port error correction. On the first sweep all four S-parameters are measured. On subsequent sweeps, the assumption is made that the reverse parameters have not changed, and only the forward parameters are measured. It is possible to override this protection feature for applications where extreme accuracy is required or in cases where the data changes significantly. To perform an override, use **MEASURE RESTART** in the stimulus menu, or for repeated update of all four S-parameters set an appropriate number of groups using the **NUMBER of GROUPS** softkey. These menus are described in Chapter 5.

Isolation calibration can be omitted for most measurements, except where wide dynamic range is a consideration. Refer to the explanation under "**CAL** Key".

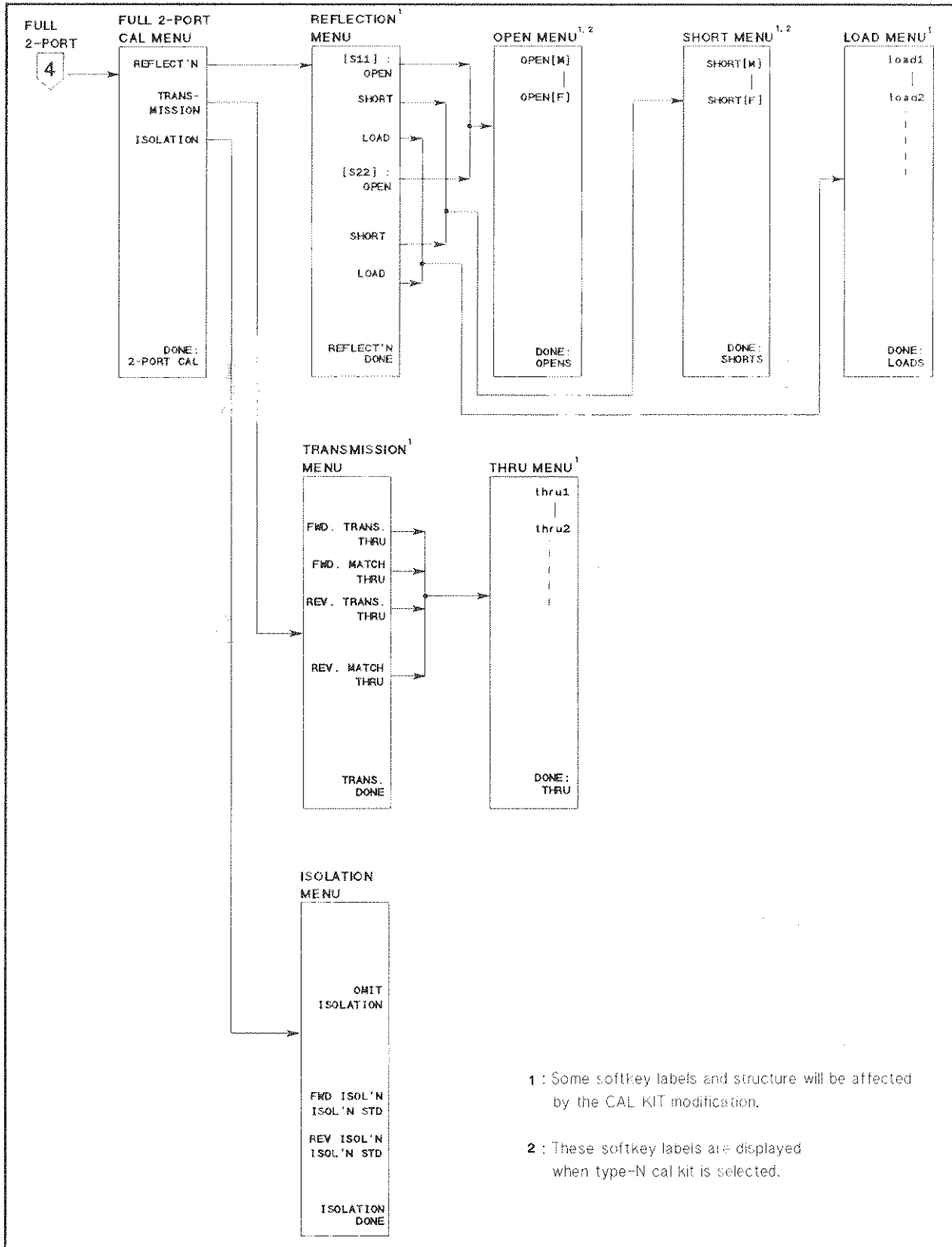

C2007028

Figure 7-16. Full 2-Port Cal Menu

Procedure for Full 2-Port Calibration

1. Press **CAL**.
2. Select the proper calibration kit. If the connector type or cal kit name shown in the **CAL KIT** softkey label is not the same as the calibration kit to be used, refer to "Select Cal Kit Menu".
3. Press **CALIBRATE MENU FULL 2-PORT REFLECT'N**.
4. Connect a shielded **OPEN** to port 1.
5. When the trace settles, press (**S₁₁**): **OPEN** (for the 7 mm cal kit) or (**S₁₁**): **OPENS** (for the type-N cal kit).
6. When the 7 mm cal kit is selected in step 2, the **OPEN** data is measured, and the softkey label **OPEN** is underlined.

When the type-N cal kit is selected in step 2, the **OPEN [M]** and **OPEN [F]** softkeys are displayed. Press **OPEN [M]** (for male port connector) or press **OPEN [F]** (for female port connector). The **OPEN** data is measured. The softkey label is then underlined.

7. Disconnect the **OPEN**, and connect a **SHORT** to port 1.
8. When the trace settles, press (**S₁₁**): **SHORT** (for the 7 mm cal kit) or (**S₁₁**): **SHORT** (for the type-N cal kit).
9. When 7 mm cal kit is selected in step 2, the **SHORT** data is measured and the softkey label **SHORT** is underlined.

When the type-N cal kit is selected in step 2, the **SHORT [M]** and **SHORT [F]** softkeys are displayed. Press **SHORT [M]** (for male port connector) or press **SHORT [F]** (for female port connector). The **SHORT** data is measured and the softkey label is then underlined.

10. Disconnect the **SHORT**, and connect an impedance-matched **LOAD** (usually 50 or 75 Ω) at port 1.
11. When the trace settles, press (**S₁₁**): **LOAD**. The **LOAD** data is measured, and the softkey label **LOAD** is underlined.
12. Repeat the **OPEN-SHORT-LOAD** measurements described above, connecting the devices in turn to port 2 and using the (**S₂₂**) softkeys.
13. Press **REFLECT'N DONE**. (If you press **DONE** without measuring all the required standards, the message "CAUTION: ADDITIONAL STANDARDS NEEDED" will be displayed.)
14. The reflection calibration coefficients are computed and stored. The two-port cal menu is displayed, with the **REFLECT'N** softkey underlined.
15. Press **TRANSMISSION**.
16. Connect a **THRU** connection between port 1 and port 2 at the points where the test device will be connected.
17. When the trace settles, press **FWD. TRANS. THRU**. **S₂₁** frequency response is measured, and the softkey is underlined.
18. Press **FWD. MATCH THRU**. **S₁₁** load match is measured, and the softkey is underlined.
19. Press **REV. TRANS. THRU**. **S₁₂** frequency response is measured, and the softkey is underlined.
20. Press **REV. MATCH THRU**. **S₂₂** load match is measured, and the softkey is underlined.
21. Press **TRANS. DONE**. The transmission coefficients are computed and stored. The two-port cal menu is displayed, with the **TRANSMISSION** softkey underlined.

22. If correction for isolation is not required, press **ISOLATION OMIT ISOLATION ISOLATION DONE**.
23. If correction for isolation is required, connect impedance-matched LOADs to port 1 and port 2.
24. Press **FWD ISOL'N ISOL'N STD**. S_{21} isolation is measured, and the softkey label is underlined.
25. Press **REV ISOL'N ISOL'N STD**. S_{12} isolation is measured, and the softkey label is underlined.
26. Press **ISOLATION DONE**. The isolation error coefficients are stored. The two-port cal menu is displayed, with the **ISOLATION** softkey underlined.
27. Press **DONE 2-PORT CAL** to complete the calibration. The error coefficients are computed and stored. The correction menu is displayed with **CORRECTION ON**. A corrected trace is displayed, and the notation "C2" at the left of the screen indicates that two-port error correction is ON.

Now the test device can be connected and measured. It is recommended that calibration data be saved using the built-in disk drive. Refer to Chapter 11.

One-Path 2-Port Calibration for Reflection and Transmission Measurements

This performs a two-port calibration without an S-parameter test set, using the series of menus illustrated in Figure 7-17. This is a highly accurate calibration for measurements of two-port devices, and effectively reduces all correctable systematic errors in one direction only.

Isolation calibration can be omitted for most measurements, except where wide dynamic range is a consideration. Refer to the explanation under "**CAL** Key".

For measurements of all four S-parameters, the device under test must be reversed between sweeps. The analyzer compatible calibration kits contain sets of phase-matched adapters that can be interchanged for measurements of non-insertable, non-reversible devices.

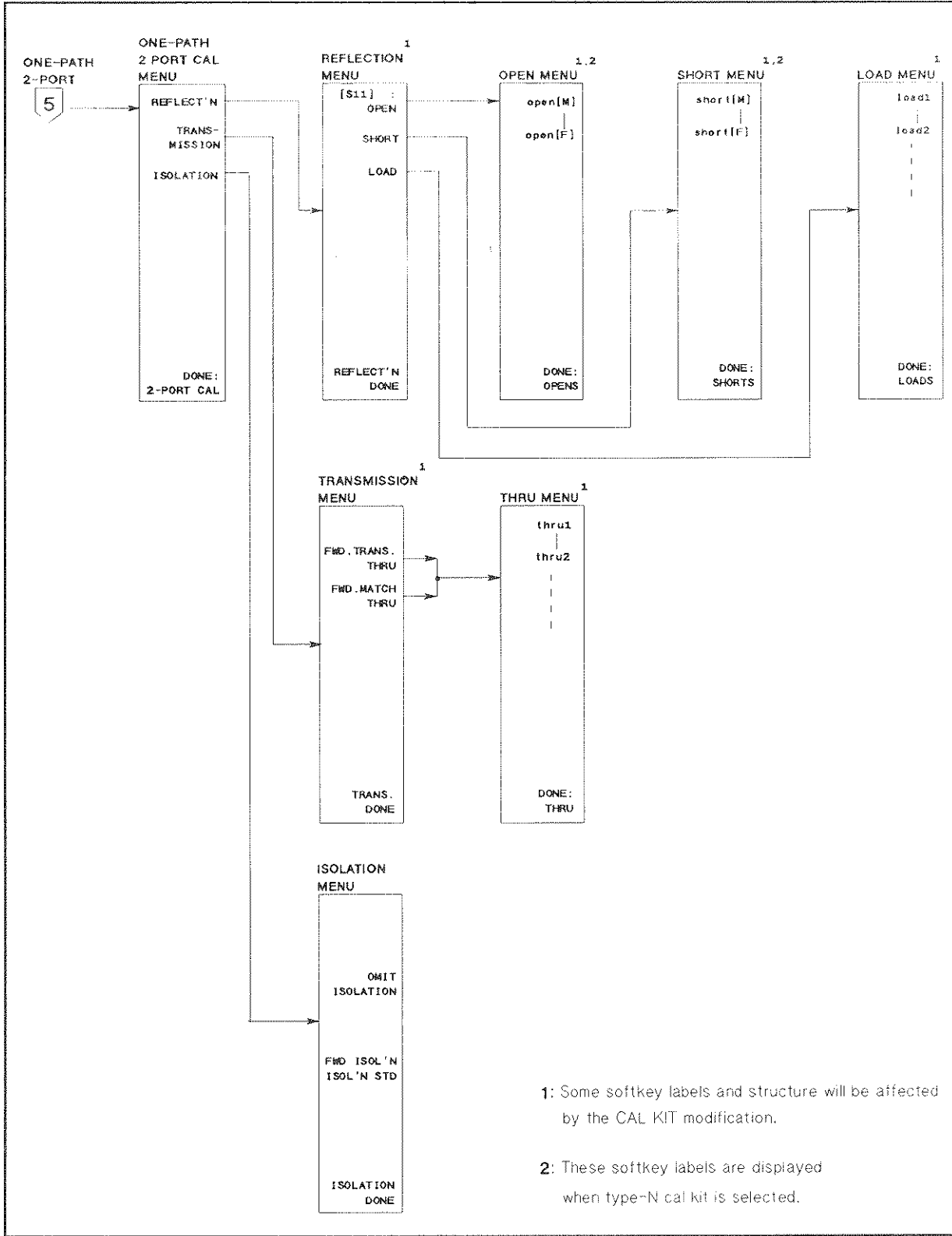

C2007009

Figure 7-17. One-Path 2-Port Cal Menu

One-Path 2-Port Calibration for Reflection and Transmission Measurements

1. Press **CAL**.
2. Select the proper calibration kit. If the connector type or cal kit name shown in the **CAL KIT** softkey label is not the same as the calibration kit to be used, refer to "Select Cal Kit Menu".
3. Press **CALIBRATE MENU ONE-PATH 2-PORT REFLECT'N**.
4. Connect a shielded OPEN to the test port.
5. When the trace settles, press **(S₁₁): OPEN** (for the 7 mm cal kit) or **(S₁₁): OPENS** (for the type-N cal kit). The OPEN data is measured, and the softkey label **OPEN** is underlined.

When the type-N cal kit is selected in step 2, the **OPEN [M]** and **OPEN [F]** softkeys are displayed. Press **OPEN [M]** (for male port connector) or press **OPEN [F]** (for female port connector). The OPEN data is measured. The softkey label is then underlined.

6. Disconnect the OPEN, and connect a SHORT to the test port.
7. When the trace settles, press **SHORT** (for the 7 mm cal kit) or **SHORTS** (for the type-N cal kit).
8. When the 7 mm cal kit is selected in step 2, the SHORT data is measured and the softkey label **SHORT** is underlined.

When the type-N cal kit is selected in step 2, the **SHORT [M]** and **SHORT [F]** softkeys are displayed. Press **SHORT [M]** (for male port connector) or press **SHORT [F]** (for female port connector). The SHORT data is measured and the softkey label is then underlined.

9. Disconnect the SHORT, and connect an impedance-matched LOAD (50 or 75 Ω) to the test port.
10. When the trace settles, press **LOAD**. The LOAD data is measured, and the softkey label **LOAD** is underlined.
11. Press **REFLECT'N DONE**. (If you press **DONE** without measuring all the required standards, the message "CAUTION: ADDITIONAL STANDARDS NEEDED" will be displayed.)
12. The reflection calibration coefficients are computed and stored. The two-port cal menu is displayed, with the **REFLECT'N** softkey underlined.
13. Connect a THRU between the test port and the return cable to the analyzer (connect the points at which the test device will be connected). Press **TRANSMISSION**.
14. When the trace settles, press **FWD. TRANS. THRU**. S_{21} frequency response is measured, and the softkey is underlined.
15. Press **FWD. MATCH THRU**. S_{11} load match is measured, and the softkey is underlined.
16. Press **TRANS. DONE**. The transmission coefficients are computed and stored. The two-port cal menu is displayed, with the **TRANSMISSION** softkey underlined.
17. If correction for isolation is not required, press **ISOLATION OMIT ISOLATION ISOLATION DONE**.
18. If correction for isolation is required, connect impedance-matched LOADs to the test port and the return port.
19. Press **FWD ISOL'N ISOL'N STD**. S_{21} isolation is measured, and the softkey label is underlined.
20. Press **ISOLATION DONE**. The isolation error coefficients are stored. The two-port cal menu is displayed, with the **ISOLATION** softkey underlined.

21. Press **DONE 2-PORT CAL** to complete the calibration. The error coefficients are computed and stored. The correction menu is displayed with **CORRECTION ON**. A corrected trace is displayed, and the notation "C2" at the left of the screen indicates that 2-port error correction is ON.

Now the test device can be connected and measured in the forward direction. When forward measurement is complete, disconnect the test device and manually reverse it, then press the **PRESS to CONTINUE** key.

It is recommended that calibration data be saved on a disk. Refer to Chapter 11.

MODIFYING CALIBRATION KITS

Note



Hewlett-Packard strongly recommends that you read application note 8510-5A before attempting to view or modify calibration standard definitions. The part number of this application note is 5956-4352. Although the application note is written for the HP 8510 family of network analyzers, it also applies to the HP 8751A. This portion of the calibration chapter provides a summary of the information in the application note, as well as HP 8751A menu-specific information.

For most applications, use the default cal kit models provided in the select cal kit menu described earlier in this chapter. Modifying calibration kits is necessary only if unusual standards are used or the very highest accuracy is required. Unless a cal kit model is provided with the calibration devices used, a solid understanding of error correction and the system error model are absolutely essential to making modifications. Read the introductory part of this chapter for more information, and refer to the Appendix to Chapter 7.

Note



Numerical data for most Hewlett-Packard calibration kits is provided in the calibration kit manuals.

During measurement calibration, the analyzer measures actual, well-defined standards and mathematically compares the results with ideal "models" of those standards. The differences are separated into error terms which are later reduced during error correction. Most of the differences are due to systematic errors - repeatable errors introduced by the analyzer, test set, and cables - which are correctable. However, the difference between the standard's mathematical *model* and its *actual performance* has an adverse affect; it reduces the system's ability to remove systematic errors, and thus degrades error-corrected accuracy. Therefore, in addition to the default cal kit models, a "user kit" is provided that can be modified to an alternate calibration standards model.

Several situations exist that may require a user-defined cal kit:

- You use a connector interface different from the three built-in cal kits. (Examples: SMA, or BNC.)

- You are using standards (or combinations of standards) that are different from the predefined cal kits. (Example: Using three offset SHORTs instead of OPEN, SHORT, and LOAD to perform a 1-port calibration.)
- You want to improve the built-in standard models for predefined kits. Remember that the more closely the model describes the actual performance of the standard, the better the calibration. (Example: The 7 mm LOAD is determined to be 50.4 Ω instead of 50.0 Ω .)
- Unused standards for a given cal type can be eliminated from the default set, to eliminate possible confusion during calibration. (Example: A certain application requires calibrating a male test port. The standards used to calibrate a female test port can be eliminated from the set, and will not be displayed during calibration.)

Definitions

The following are definitions of terms:

- A **standard** is a specific, well-defined, physical device used to determine systematic errors.
- A standard **type** is one of five basic types that define the form or structure of the model to be used with that standard (e.g. SHORT or LOAD).
- Standard **coefficients** are numerical characteristics of the standards used in the model selected.
- A standard **class** is a grouping of one or more standards that determines which standards are used in a particular calibration procedure.

Procedure

The following steps are used to modify or define a user kit:

1. Select the predefined kit to be modified. This is not necessary for defining a new cal kit.
2. Define the standards. For each standard, define which *type* of standard it is and its electrical characteristics.
3. Specify the *class* where the standard is to be assigned.
4. Store the modified cal kit.

The standard definitions of predefined calibration kits are shown in Appendix A.

Modify Cal Kit Menu

This menu is accessed from **CAL** **CAL KIT** **MODIFY** (refer to Figure 7-6), and leads to additional menus associated with modifying cal kits. The analyzer directly supports 7 mm, 50 Ω type-N, and 75 Ω type-N connector types.

For other connector types, you must modify the existing standards definitions. This menu provides access to the default calibration standards definitions. A “User Kit” is provided for convenience. It can be redefined without affecting the definitions.

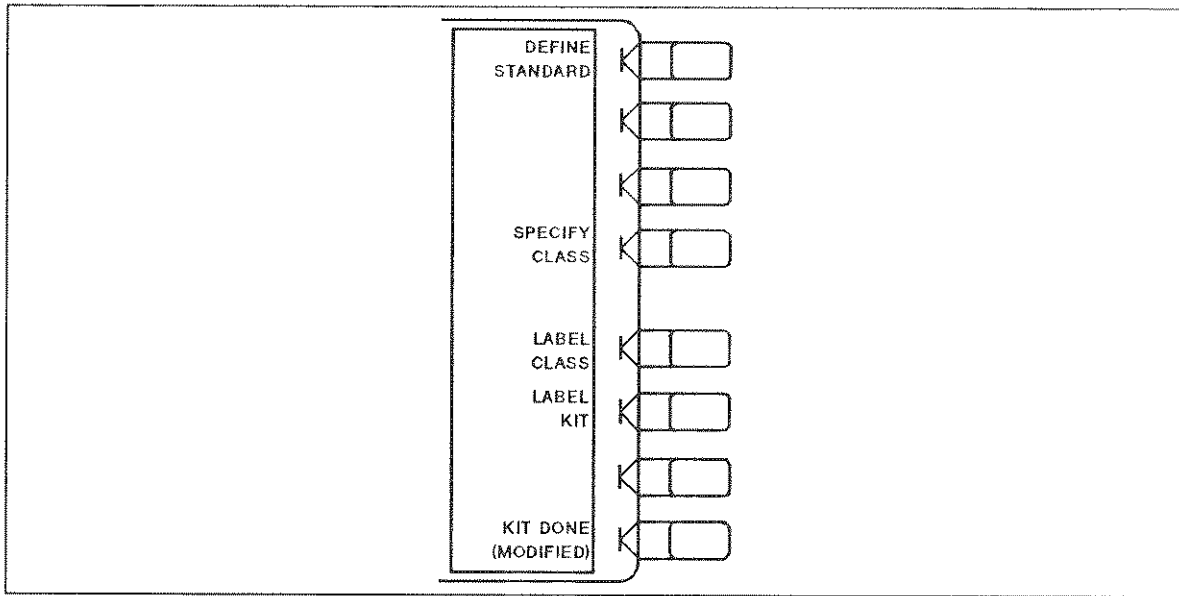

C2067027

Figure 7-18. Modify Cal Kit Menu

DEFINE STANDARD (DEFS) makes the standard number the active function, and brings up the define standard number menus. The standard number (1 to 8) is an arbitrary reference number used to reference standards while specifying a class. Each number is similar to a register, in that it holds certain information. Each contains the selected type of device (OPEN, SHORT, or THRU) and the electrical model for that device. The standard numbers for the predefined calibration kits are as follows:

1 SHORT	5 LOAD
2 OPEN	6 LOAD
3 LOAD	7 SHORT
4 DEL/THRU	8 OPEN

SPECIFY CLASS leads to the specify class menu. After the standards are modified, use this key to specify a class to consist of certain standards.

LABEL CLASS leads to the label class menu, to give the class a meaningful label for future reference.

LABEL KIT (LABK) leads to a menu for constructing a label for the user-modified cal kit. If a label is supplied, it will appear as one of the five softkey choices in the select cal kit menu. The approach is similar to defining a display title, except that the kit label is limited to ten characters. Refer to **DISPLAY** Key, Title Menu in Chapter 6 for details.

KIT DONE (KITD) terminates the cal kit modification process, after all standards are defined and all classes are specified. Be sure to save the kit with the **SAVE USER KIT** softkey, if it is to be used later.

Define Standard Number Menu

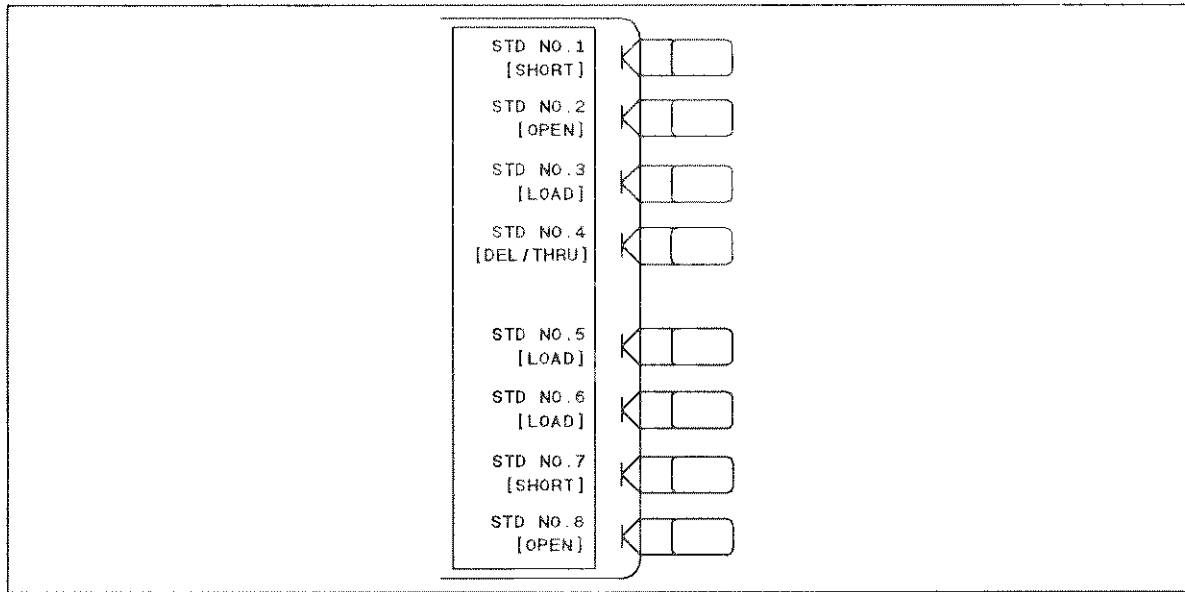

Figure 7-19. Define Standard Number Menu

STD NO. 1 selects standard No.1 as the standard definition.

STD NO. 2 selects standard No.2 as the standard definition.

STD NO. 3 selects standard No.3 as the standard definition.

STD NO. 4 selects standard No.4 as the standard definition.

STD NO. 5 selects standard No.5 as the standard definition.

STD NO. 6 selects standard No.6 as the standard definition.

STD NO. 7 selects standard No.7 as the standard definition.

STD NO. 8 selects standard No.8 as the standard definition.

Define Standard Menus

Standard definition is the process of mathematically modeling the electrical characteristics (delay, attenuation, and impedance) of each calibration standard. These electrical characteristics (coefficients) can be mathematically derived from the physical dimensions and material of each calibration standard, or from its actual measured response. The parameters of the standards can be listed in Standards Definitions, Table 7-3. The menus illustrated in Figure 7-20 specify the type and characteristics for each user-defined standard.

Table 7-3. Standard Definitions

NO.	STANDARD TYPE	C0 $\times 10^{-15} \text{ F}$	C1 $\times 10^{-27} \text{ F/Hz}$	C2 $\times 10^{-36} \text{ F/Hz}^2$	OFFSET DELAY ps	OFFSET LOSS M Ω /s	OFFSET Z ₀ Ω	STANDARD LABEL
1								
2								
3								
4								
5								
6								
7								
8								

Each standard must be identified as one of five “types”: OPEN, SHORT, LOAD, DELAY/THRU, or arbitrary impedance.

After a standard number is entered, selection of the standard type will present one of five menus for entering the electrical characteristics (model coefficients) corresponding to that standard type. These menus are tailored to the current type, so that only characteristics applicable to the standard type can be modified.

Any standard type can be further defined with offsets in delay, loss, and standard impedance (Z₀). Press the **SPECIFY OFFSET** key, and refer to the specify offset menu.

A distinct label can be defined and assigned to each standard, so that the analyzer can prompt the user with explicit standard labels during calibration (e.g. “SHORT”). Press the **LABEL STD** softkey. The function is similar to defining a display title, except that the label is limited to ten characters. Refer to **DISPLAY** Key, “Title Menu” in Chapter 6 for details.

After each standard is defined, including offsets, press **STD DONE (DEFINED)** to terminate the standard definition.

The standard definitions can be listed on screen and printed using COPY function. (Refer to Chapter 10.)

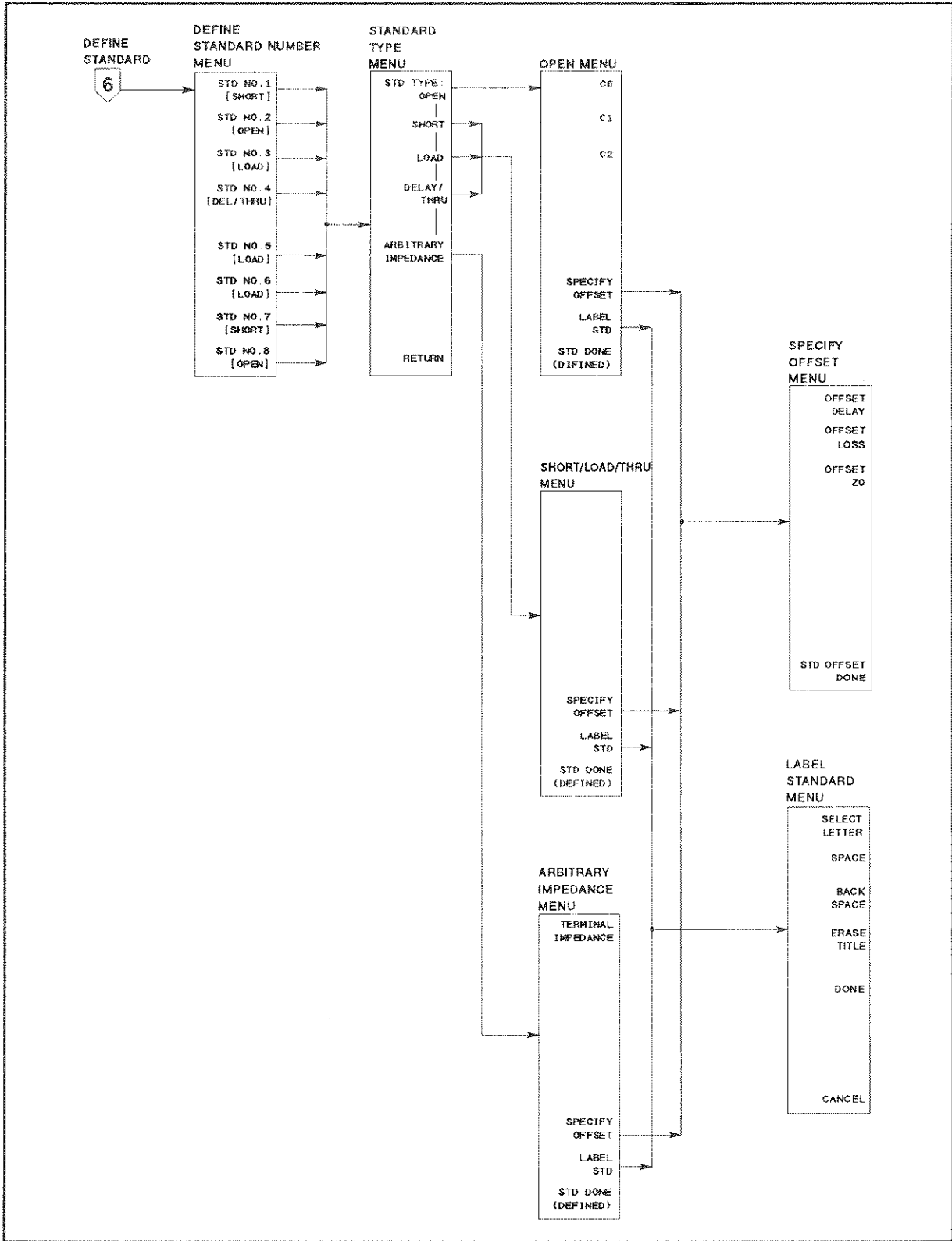

C2007050

Figure 7-20. Define Standard Menus

OPEN (STDTOPEN) defines the standard type as an OPEN, used for calibrating reflection measurements. OPENs are assigned a terminal impedance of infinite ohms, but delay and loss offsets may still be added. Pressing this key also brings up a menu for defining the OPEN, including its capacitance.

As a reflection standard, an OPEN offers the advantage of broadband frequency coverage. However, an OPEN rarely has perfect reflection characteristics because fringing (capacitance) effects cause phase shift that varies with frequency. This can be observed in measuring an OPEN termination after calibration, when an arc in the lower right circumference of the Smith chart indicates capacitive reactance. These effects are impossible to eliminate, but the calibration kit models include the OPEN termination capacitance at all frequencies for compatible calibration kits. The capacitance model is a second order polynomial (squared term), as a function of frequency, where the polynomial coefficients are user-definable. The capacitance model equation is:

$$C = C_0 + C_1 \times F + C_2 \times F^2$$

where F is the measurement frequency.

The terms in the equation are defined with the specify open menu as follows:

C0 (C0) enters the C_0 term, which is the constant term of the square polynomial and is scaled by 10^{-15} Farads.

C1 (C1) enters the C_1 term, expressed in F/Hz (Farads/Hz) and scaled by 10^{-27} .

C2 (C2) enters the C_2 term, expressed in F/Hz² and scaled by 10^{-36} .

SHORT (STDTSHOR) defines the standard type as a SHORT, for calibrating reflection measurements. SHORTs are assigned a terminal impedance of 0 Ω , but delay and loss offsets may still be added.

LOAD (STDTLOAD) defines the standard type as a LOAD (termination). LOADs are assigned a terminal impedance equal to the system characteristic impedance Z_0 , but delay and loss offsets may still be added. If the LOAD impedance is not Z_0 , use the arbitrary impedance standard definition.

DELAY/THRU (STDTDELA) defines the standard type as a transmission line of specified length, for calibrating transmission measurements.

ARBITRARY IMPEDANCE (STDTARBI) defines the standard type to be a LOAD, but with an arbitrary impedance (different from system Z_0).

TERMINAL IMPEDANCE (TERI) specifies the (arbitrary) impedance of the standard, in ohms.

STD DONE(DEFINED) terminates the standard definition. Press this after each standard defined, including offsets.

Specify Offset Menu

The specify offset menu allows additional specifications for a user-defined standard. Features specified in this menu are common to all five types of standards.

Offsets may be specified with any standard type. This means defining a uniform length of transmission line to exist between the standard being defined and the actual measurement plane. For reflection standards, the offset is assumed to be between the measurement plane and the standard (one-way only). For transmission standards, the offset is assumed to exist between the two reference planes (in effect, the offset is the THRU). Three characteristics of the offset can be defined: its delay (length), loss, and impedance.

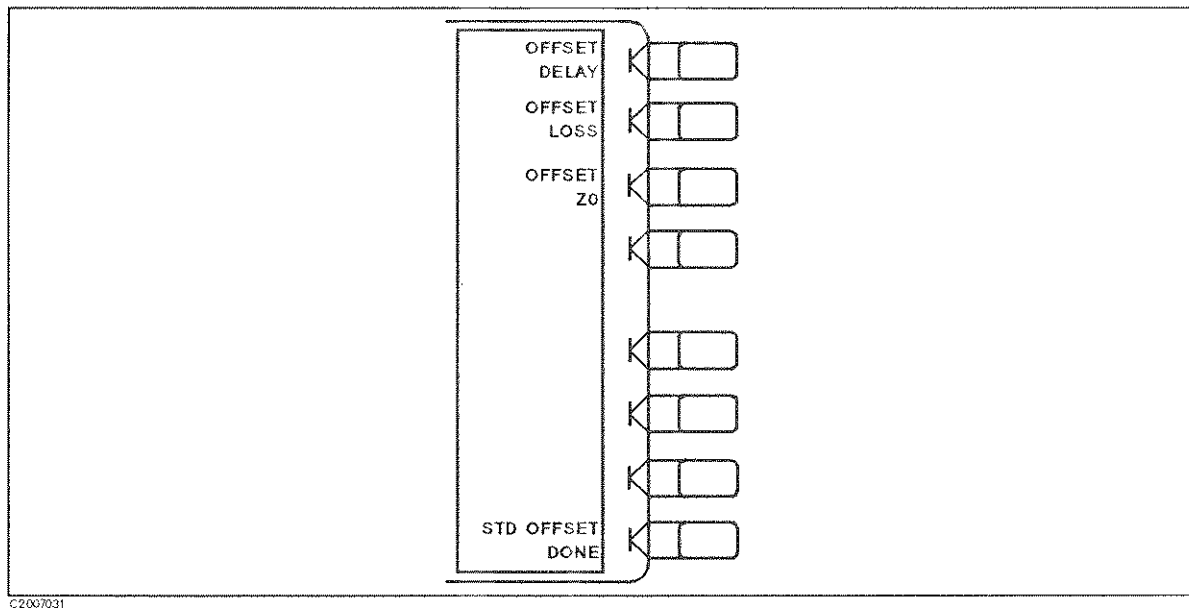

Figure 7-21. Specify Offset Menu

OFFSET DELAY (OFSD) specifies the one-way electrical delay from the measurement (reference) plane to the standard, in seconds (s). (In a transmission standard, offset delay is the delay from plane to plane.) Delay can be calculated from the precise physical length of the offset, the permittivity constant of the medium, and the speed of light.

OFFSET LOSS (OFSL) specifies energy loss, due to skin effect, along a one-way length of coaxial cable offset. The value of loss is entered as ohms/nanosecond (or Giga ohms/second) at 1 GHz.

OFFSET Z0 (OFSZ) specifies the characteristic impedance of the coaxial cable offset.

Note

This is not the impedance of the standard itself.



Label Standard Menu

This menu labels (reference) individual standards during the menu-driven measurement calibration sequence. The labels are user-definable using a character set displayed on the display that includes letters, numbers, and some symbols, and they may be up to ten characters long. The analyzer will prompt you to connect standards using these labels, so they should be meaningful to you, and distinct for each standard.

By convention, when sexed connector standards are labeled male (m) or female (f), the designation refers to the test port connector sex, not the connector sex of the standard.

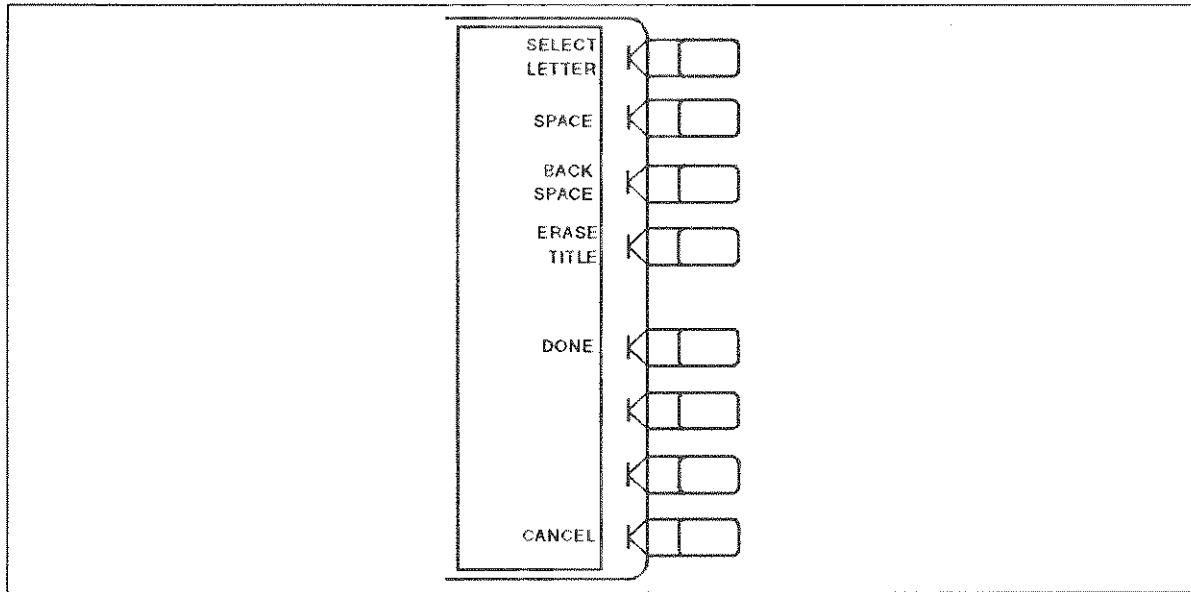

Figure 7-22. Label Standard Menu

Standard labels are created in the same way as titles. Refer to “**DISPLAY** KEY” in Chapter 6, “Title Menu” in Chapter 6.

Specify Class Menus

Once a standard is specified, it must be assigned to a standard *class*. This is a group of from one to seven standards that is required to calibrate for a single error term. The standards within a single class are assigned to locations A through G as listed on the Standard Class Assignments Table (Table 7-4). A class often consists of a single standard, but may be composed of more than one standard.

The standard class assignments of predefined standard kits are shown in Appendix A.

Table 7-4. Standard Class Assignments Table

CLASS	A	B	C	D	E	F	G	STANDARD CLASS LABEL
S _{11A}								
S _{11B}								
S _{11C}								
S _{22A}								
S _{22B}								
S _{22C}								
Forward Transmission								
Reverse Transmission								
Forward Match								
Reverse Match								
Response								
Response & Isolation								

The number of standard classes required depends on the type of calibration being performed, and is identical to the number of error terms corrected. (Examples: A response cal requires only one class, and the standards for that class may include an OPEN, or SHORT, or THRU. A 1-port cal requires three classes. A full 2-port cal requires 10 classes, not including two for isolation.)

The number of standards that can be assigned to a given class may vary from none (class not used) to one (simplest class) to seven. When a certain class of standards is required during calibration, the analyzer will display the labels for all the standards in that class (except when the class consists of a single standard). This does not, however, mean that all standards in a class must be measured during calibration. Only a single standard per class is required. Note that it is often simpler to keep the number of standards per class to the bare minimum needed (often one) to avoid confusion during calibration.

Standards are assigned to a class simply by entering the standard's reference number (established while defining a standard) under a particular class.

Each class can be given a user-definable label as described under "Label Class Menus".

The class assignments table can be displayed on screen and printed using COPY function. (Refer to Chapter 10.)

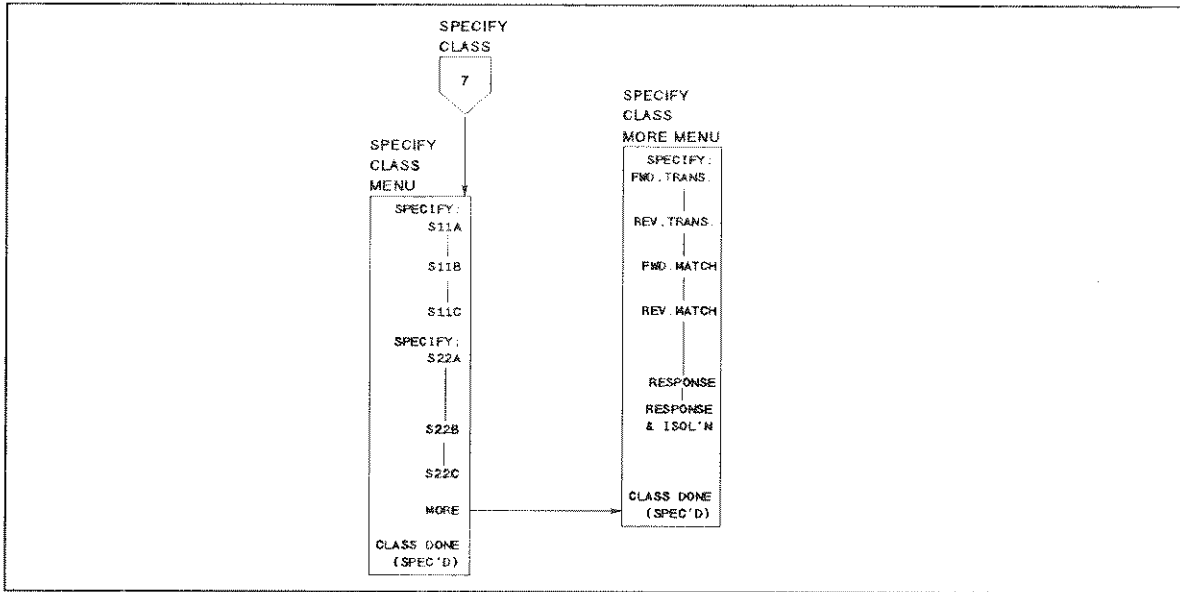

Figure 7-23. Specify Class Menus

SPECIFY: S11A (SPECS11A) enters the standard numbers for the first class required for an S_{11} 1-port calibration. (For predefined cal kits, this is OPEN (for the 7 mm) or OPENS (for type-N).)

S11B (SPECS11B) enters the standard numbers for the second class required for an S_{11} 1-port calibration. (For predefined cal kits, this is SHORT (for the 7 mm) or SHORTS (for the type-N).)

S11C (SPECS11C) enters the standard numbers for the third class required for an S_{11} 1-port calibration. (For predefined kits, this is the LOAD.)

SPECIFY: S22A (SPECS22A) enters the standard numbers for the first class required for an S_{22} 1-port calibration. (For predefined cal kits, this is OPEN (for the 7 mm) or OPENS (for the type-N).)

S22B (SPECS22B) enters the standard numbers for the second class required for an S_{22} 1-port calibration. (For predefined cal kits, this is SHORT (for the 7 mm) or SHORTS (for the type-N).)

S22C (SPECS22C) enters the standard numbers for the third class required for an S_{22} 1-port calibration. (For predefined kits, this is the LOAD.)

MORE leads to the following softkeys.

FWD. TRANS. (SPECFWDT) enters the standard numbers for the forward transmission (THRU) calibration. (For predefined kits, this is the THRU.)

REV. TRANS. (SPECREVT) enters the standard numbers for the reverse transmission (THRU) calibration. (For predefined kits, this is the THRU.)

FWD. MATCH (SPECFWDM) enters the standard numbers for the forward match (THRU) calibration. (For predefined kits, this is the THRU.)

REV. MATCH (SPECREVM) enters the standard numbers for the reverse match (THRU) calibration. (For predefined kits, this is the THRU.)

RESPONSE (SPECRESP) enters the standard numbers for a response calibration. This calibration corrects for frequency response in either reflection or transmission measurements, depending on the parameter being measured when a calibration is performed. (For predefined kits, the standard is either the OPEN or SHORT for reflection measurements, or the THRU for transmission measurements.)

RESPONSE & ISOL'N (SPECRESI) enters the standard numbers for a response & isolation calibration. This calibration corrects for frequency response and directivity in reflection measurements, or frequency response and isolation in transmission measurements.

Label Class Menus

These define meaningful labels for the calibration classes. These then become softkey labels during a measurement calibration. Labels can be up to ten characters long.

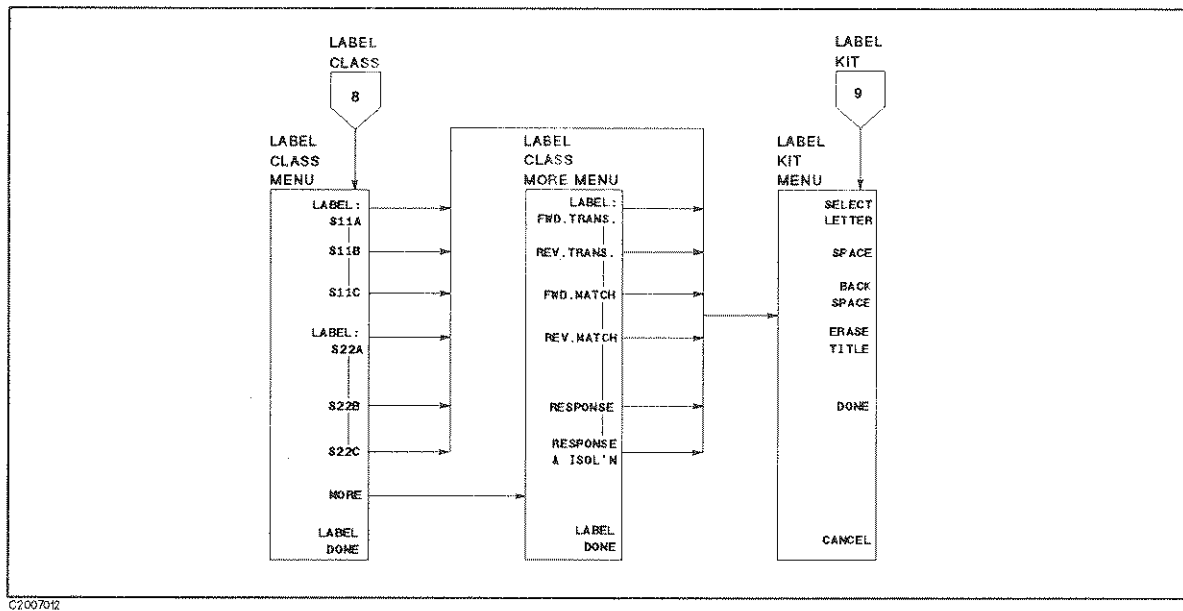

Figure 7-24. Label Class Menus

Labels are created in the same way as display titles. Refer to **DISPLAY** Key, "Title Menu" in Chapter 6.

Label Kit Menu

After a new calibration kit has been defined, be sure to specify a label for it. Choose a label that describes the connector type of the calibration devices. This label will then appear in the **CAL KIT** softkey label in the correction menu and the **MODIFY** label in the select cal kit menu. It will be saved with calibration data.

This menu is accessed with the **LABEL KIT** softkey in the modify cal kit menu, and is identical to the label class menu and the label standard menu described above. It allows definition of a label up to eight characters long.

Verify Performance

Once a measurement calibration has been generated with a user-defined calibration kit, its performance should be checked before making device measurements. To check the accuracy that can be obtained using the new calibration kit, a device with a well-defined frequency response should be measured. The verification device must not be one of the calibration standards: measurement of one of these standards is merely a measure of repeatability.

To achieve more complete verification of a particular measurement calibration, accurately known verification standards with a diverse magnitude and phase response should be used. NIST traceable or HP standards are recommended to achieve verifiable measurement accuracy.

Note



The published specifications for the HP 8751A network analyzer system include accuracy enhancement with compatible calibration kits. Measurement calibrations made with user-defined or modified calibration kits are not subject to the HP 8751A specifications, although a procedure similar to the system verification procedure may be used.

Example Procedure for Specifying a User-Defined Calibration Kit

The following procedure enters the HP 85033C 3.5 mm calibration kit values as a "user kit." This is provided as an example to illustrate the steps required in defining a calibration kit model.

Note



Numerical data for most Hewlett-Packard calibration kits is provided in the calibration kit manuals.

Example Procedure for Specifying a User-Defined Calibration Kit

1. The first keystroke sequence enters the values for standard #1, the SHORT.
 - a. **CAL** CAL KIT MODIFY
 - b. **DEFINE STANDARD STD NO.1 [SHORT] SHORT**
 - c. **SPECIFY OFFSET OFFSET DELAY .016695 **G/n****
 - d. **OFFSET LOSS 1300 **M/μ****
 - e. **OFFSET Z₀ 50 **X1****
 - f. **STD OFFSET DONE STD DONE (DEFINED)**
2. The next sequence specifies standard #2, the OPEN.
 - a. **DEFINE STANDARD STD NO.2 [OPEN] OPEN**
 - b. **C0 53 **X1****
 - c. **C1 150 **X1****
 - d. **C2 0 **X1****
 - e. **SPECIFY OFFSET OFFSET DELAY .014491 **G/n****
 - f. **OFFSET LOSS 1300 **M/μ****
 - g. **OFFSET Z₀ 50 **X1****
 - h. **STD OFFSET DONE STD DONE (DEFINED)**

3. The next sequence specifies standard #3, the LOAD.
 - a. DEFINE STANDARD STD NO.3 [LOAD] LOAD
 - b. SPECIFY OFFSET OFFSET DELAY 0 (G/n)
 - c. OFFSET LOSS 1300 (M/μ)
 - d. OFFSET Z₀ 50 (X1)
 - e. STD OFFSET DONE STD DONE (DEFINED)
4. The next sequence specifies standard #4, the DELAY/THRU.
 - a. DEFINE STANDARD STD NO.4 [DEL/THRU] DEL/THRU
 - b. SPECIFY OFFSET OFFSET DELAY 0 (G/n)
 - c. OFFSET LOSS 1300 (M/μ)
 - d. OFFSET Z₀ 50 (X1)
 - e. STD OFFSET DONE STD DONE (DEFINED)
5. The final sequence labels the kit and saves it in memory.
 - a. LABEL KIT
 - b. Use the knob, the (↓), (↑) keys and softkeys to modify the label to read "3.5mmC"
 - c. DONE KIT DONE (MODIFIED)
 - d. CAL KIT [3.5mmC]
 - e. SAVE USER KIT
 - f. USER KIT

The USER KIT softkey is now underlined.

APPENDIX TO CHAPTER 7

Accuracy Enhancement Fundamentals-Characterizing Systematic Errors

One-Port Error Model

In a measurement of the reflection coefficient (magnitude and phase) of an unknown device, the measured data differs from the actual, no matter how carefully the measurement is made. Directivity, source match, and reflection signal path frequency response (tracking) are the major sources of error (Figure 7-25).

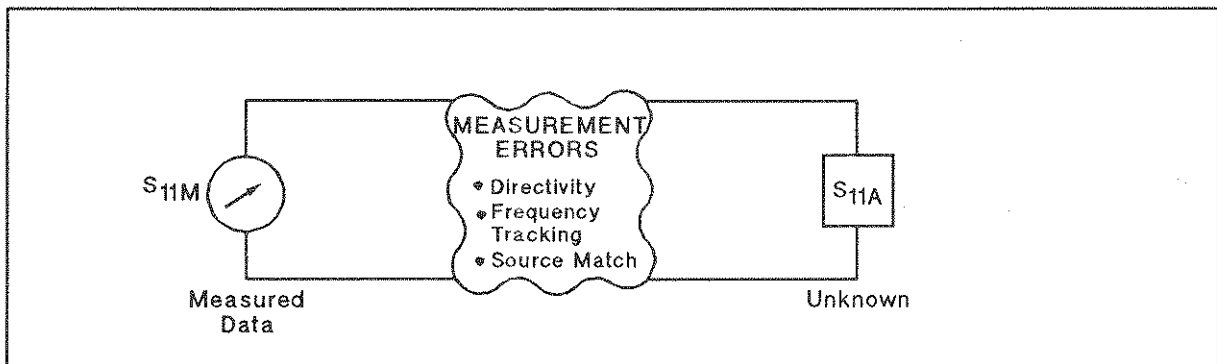

C2007045

Figure 7-25. Sources of Error in a Reflection Measurement

Measuring reflection coefficient. The reflection coefficient is measured by first separating the incident signal (I) from the reflected signal (R), then taking the ratio of the two values (Figure 7-26). Ideally, (R) consists only of the signal reflected by the test device (S_{11A}).

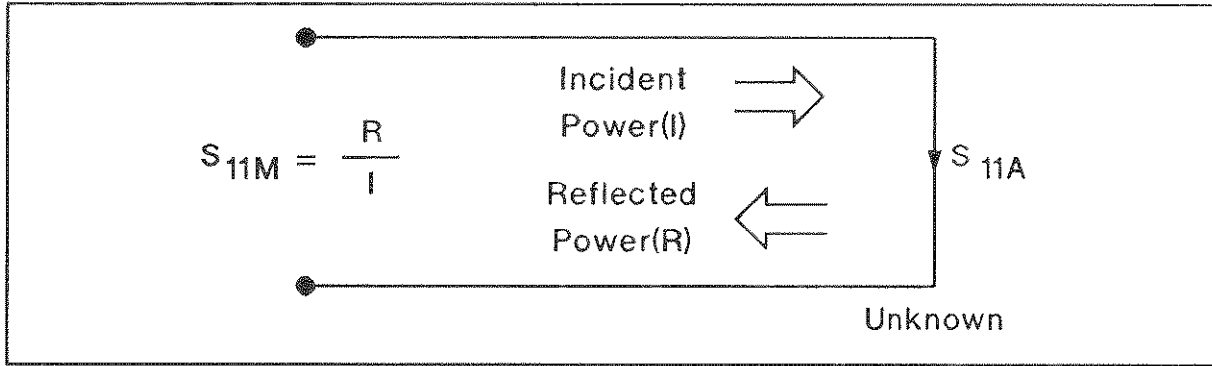

C2007046

Figure 7-26. Reflection Coefficient

Directivity error. However, all of the incident signal does not always reach the unknown (see Figure 7-27). Some of (I) may appear at the measurement system input due to leakage through the test set or other signal separation device. Also, some of (I) may be reflected by imperfect adapters between signal separation and the measurement plane. The vector sum of the leakage and miscellaneous reflections is directivity, E_{DF} . Understandably, the measurement is distorted when the directivity signal combines vectorally with the actual reflected signal from the unknown, S_{11A} .

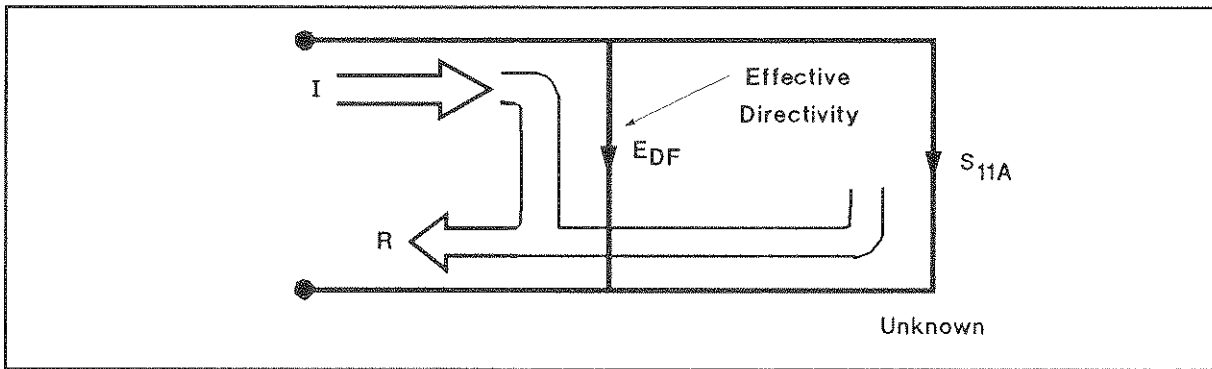

C2007047

Figure 7-27. Effective Directivity E_{DF}

Source match error. Since the measurement system test port is never exactly the characteristic impedance (50Ω or 75Ω), some of the reflected signal is re-reflected off the test port, or other impedance transitions further down the line, and back to the unknown, adding to the original incident signal (I). This effect causes the magnitude and phase of the incident signal to vary as a function of S_{11A} and frequency. Leveling the source to produce constant (I) reduces this error, but since the source cannot be exactly leveled at the test device input, leveling cannot eliminate all power variations. This re-reflection effect and the resultant incident power variation are caused by the source match error, E_{SF} (Figure 7-28).

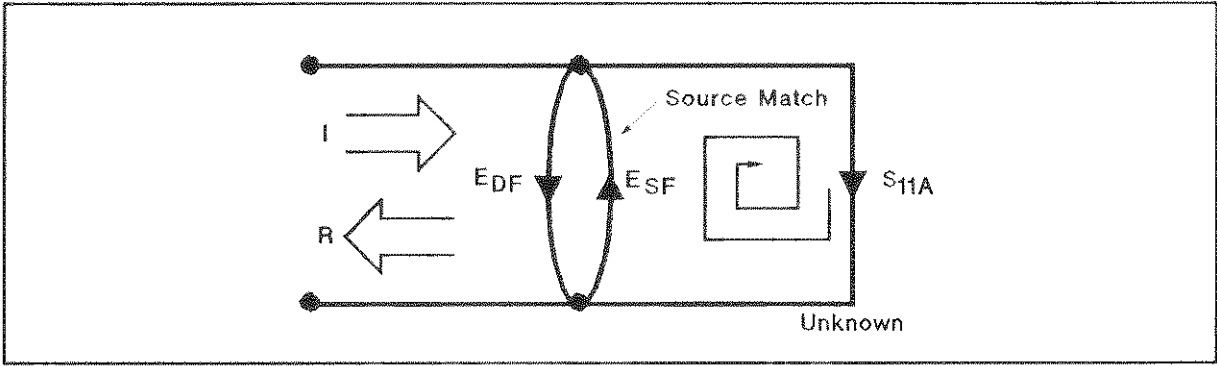

Figure 7-28. Source Match E_{SF}

Frequency response error. Frequency response (tracking) error is caused by variations in magnitude and phase flatness versus frequency between the test and reference signal paths. These are due mainly to imperfectly matched receiver circuits and differences in length and loss between incident and test signal paths. The vector sum of these variations is the reflection signal path tracking error, E_{RF} (Figure 7-29).

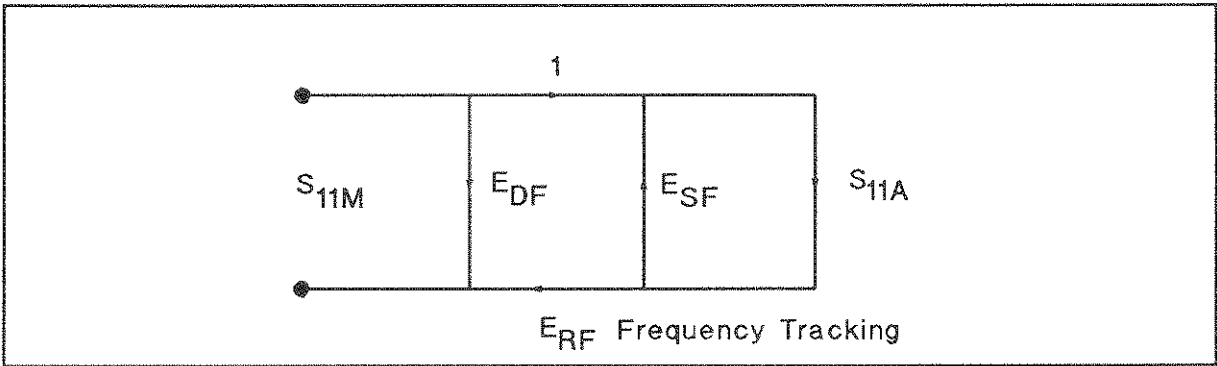

Figure 7-29. Reflection Tracking E_{RF}

How calibration standards are used to quantify these error terms. It can be shown that these three errors are mathematically related to the actual data, S_{11A} , and measured data, S_{11M} , by the following equation:

$$S_{11M} = E_{DF} + \frac{S_{11A}(E_{RF})}{1 - E_{SF}S_{11A}}$$

If the value of these three “ E ” errors and the measured test device response were known for each frequency, the above equation could be solved for S_{11A} to obtain the actual test device response. Because each of these errors changes with frequency, their values must be known at each test frequency. These values are found by measuring the system at the measurement plane using three independent standards whose S_{11A} is known at all frequencies.

The first standard applied is a “perfect load”, which makes $S_{11A} = 0$ and essentially measures directivity (Figure 7-30). “Perfect load” implies a reflectionless termination at the measurement plane. All incident energy is absorbed. With $S_{11A} = 0$ the equation can be solved for E_{DF} , the directivity term. In practice, of course, the “perfect load” is difficult to achieve, although very good broadband LOADs are available in the HP 8751A compatible calibration kits.

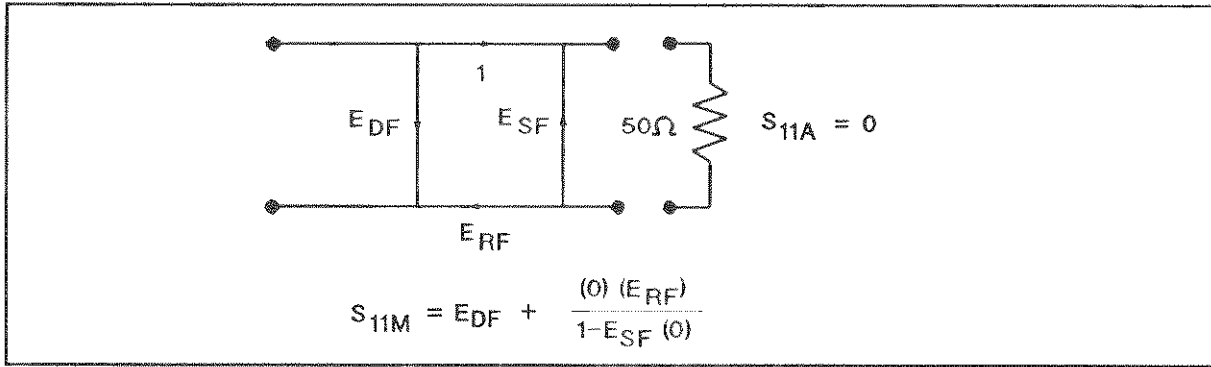

C7007050

Figure 7-30. "Perfect Load" Termination

Since the measured value for directivity is the vector sum of the actual directivity plus the actual reflection coefficient of the "perfect load", any reflection from the termination represents an error. System effective directivity becomes the actual reflection coefficient of the "perfect load" (Figure 7-31). In general, any termination having a return loss value greater than the uncorrected system directivity reduces reflection measurement uncertainty.

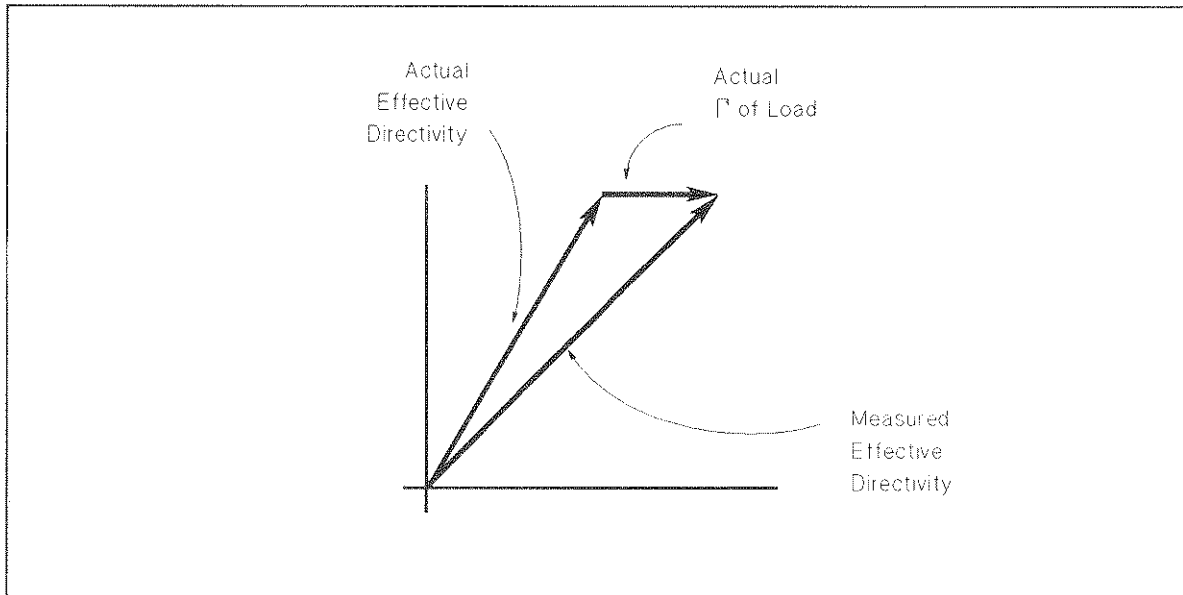

C2007051

Figure 7-31. Measured Effective Directivity

Next, a SHORT termination whose response is known to a very high degree establishes another condition (Figure 7-32).

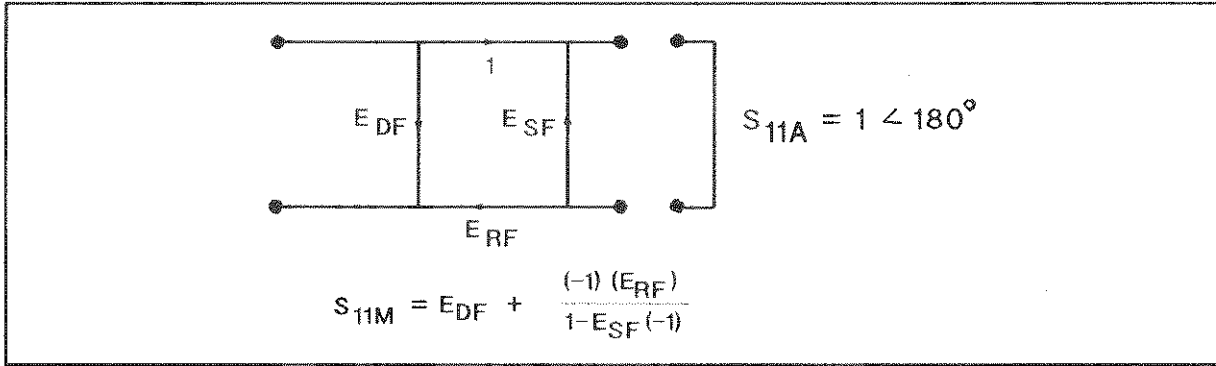

C2007052

Figure 7-32. Short Circuit Termination

The OPEN gives the third independent condition. In order to accurately model the phase variation with frequency due to radiation from the OPEN connector, a specially designed shielded OPEN is used for this step. (The OPEN capacitance is different with each connector type). Now the values for E_{DF} , directivity, E_{SF} , source match, and E_{RF} , reflection frequency response, are computed and stored (Figure 7-33).

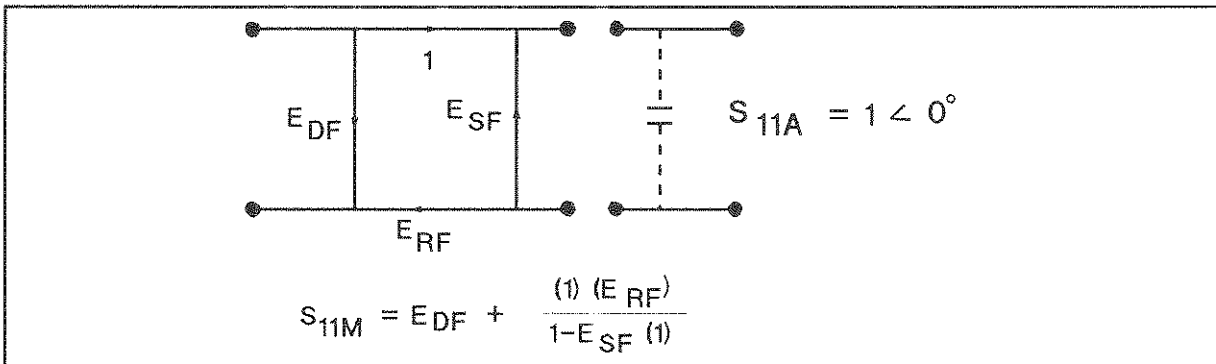

C2007053

Figure 7-33. Open Circuit Termination

Now the unknown is measured to obtain a value for the measured response, S_{11M} , at each frequency (Figure 7-34).

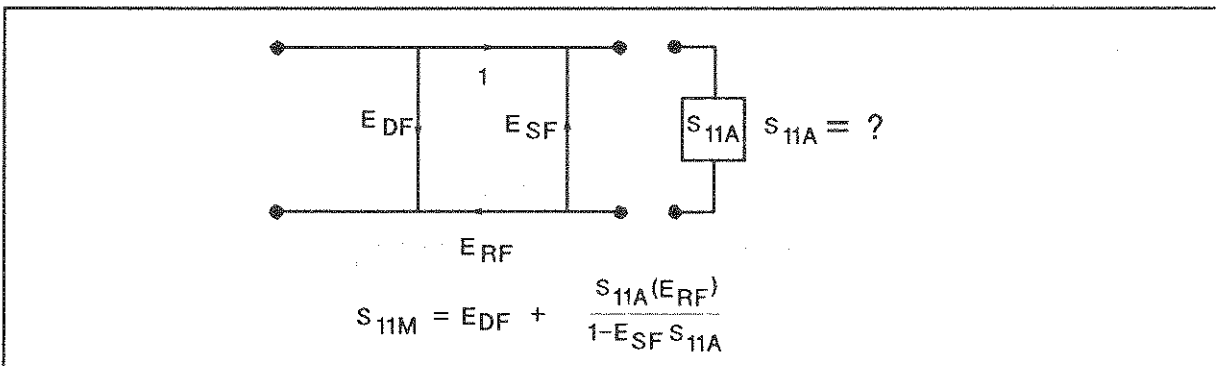

C2007054

Figure 7-34. Measured S_{11}

This is the one-port error model equation solved for S_{11A} . Since the three errors and S_{11M} are now known for each test frequency, S_{11A} can be computed as follows:

$$S_{11A} = \frac{S_{11M} - E_{DF}}{E_{SF}(S_{11M} - E_{DF}) + E_{RF}}$$

For reflection measurements on two-port devices, the same technique can be applied, but the test device output port must be terminated in the system characteristic impedance. This termination should be at least as good (have as low a reflection coefficient) as the LOAD used to determine directivity. The additional reflection error caused by an improper termination at the test device output port is not incorporated into one-port error model.

Two-Port Error Model

The error model for measurement of the transmission coefficients (magnitude and phase) of a two-port device is derived in a similar manner. The major sources of error are frequency response (tracking), source match, load match, and isolation (Figure 7-35). These errors are effectively removed using the full two-port error model.

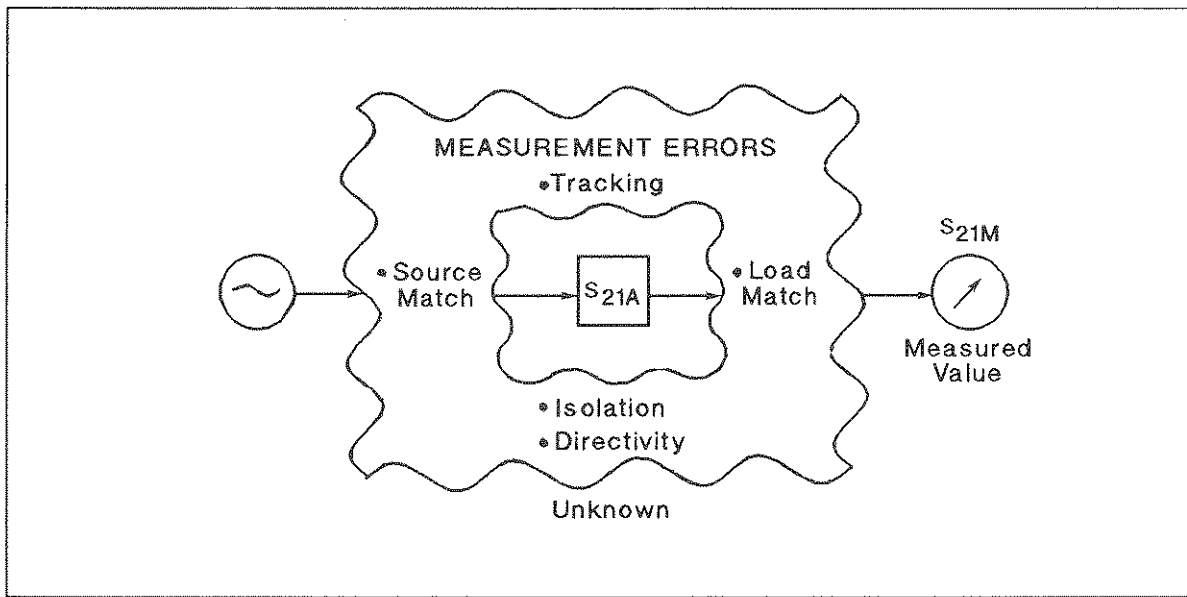

Figure 7-35. Major Sources of Error

Measuring Transmission Coefficient. The transmission coefficient is measured by taking the ratio of the incident signal (I) and the transmitted signal (T) (Figure 7-36). Ideally, (I) consists only of power delivered by the source, and (T) consists only of power emerging at the test device output.

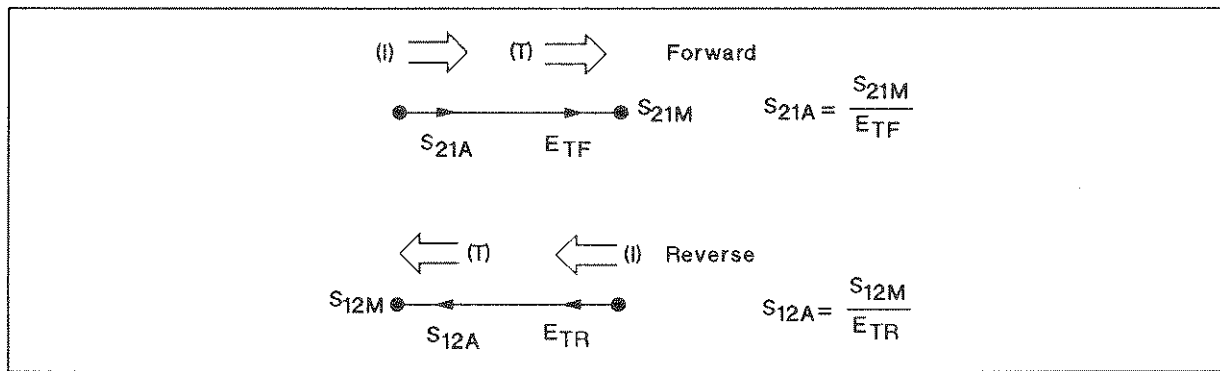

Figure 7-36. Transmission Coefficient

Load Match Error. As in the reflection model source match can cause the incident signal to vary as a function of test device S_{11A} . Also, since the test setup transmission return port is never exactly the characteristic impedance, some of the transmitted signal is reflected from the test set port 2, and from other mismatches between the test device output and the receiver input, to return to the test device. A portion of this signal may be re-reflected at port 2, thus affecting S_{21M} , or part may be transmitted through the device in the reverse direction to appear at port 1, thus affecting S_{11M} . This error term, which causes the magnitude and phase of the transmitted signal to vary as a function of S_{22A} , is called load match, E_{LF} (Figure 7-37).

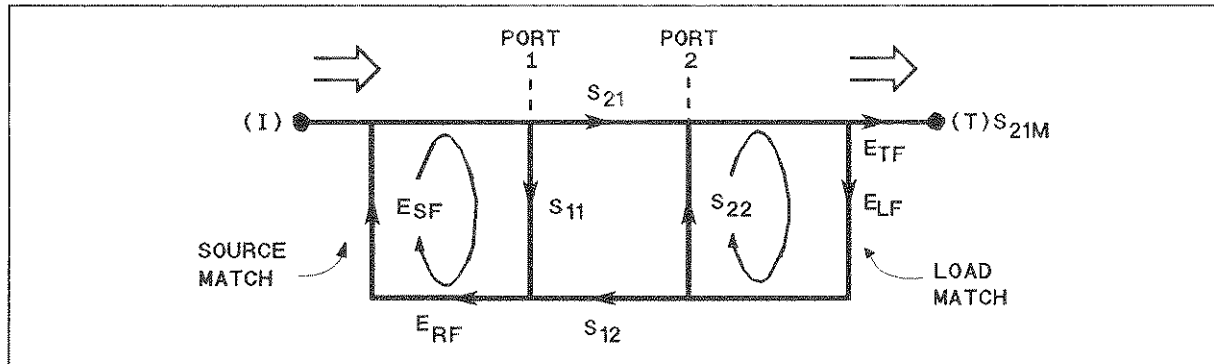

Figure 7-37. Load Match E_{LF}

The measured value, S_{21M} , consists of signal components that vary as a function of the relationship between E_{SF} and S_{11A} as well as E_{LF} and S_{22A} , so the input and output reflection coefficients of the test device must be measured and stored for use in the S_{21A} error correction computation. Thus, the test setup is calibrated as described above for the reflection to establish the directivity, E_{DF} , source match, E_{SF} , and reflection frequency response, E_{RF} , terms for the reflection measurements.

Now, that a calibrated port is available for reflection measurements, the THRU is connected and load match, E_{LF} , is determined by measuring the reflection coefficient of the THRU connection.

Transmission signal path frequency response is then measured with the THRU connected. The data is corrected for source and load match effects, then stored as transmission frequency response, E_{TF} .

Isolation Errors. Isolation, E_{XF} , represents the part of the incident signal that appears at the receiver without actually passing through the test device (Figure 7-38). Isolation is measured with the test set in the transmission configuration and with terminations installed at the points where the test device will be connected.

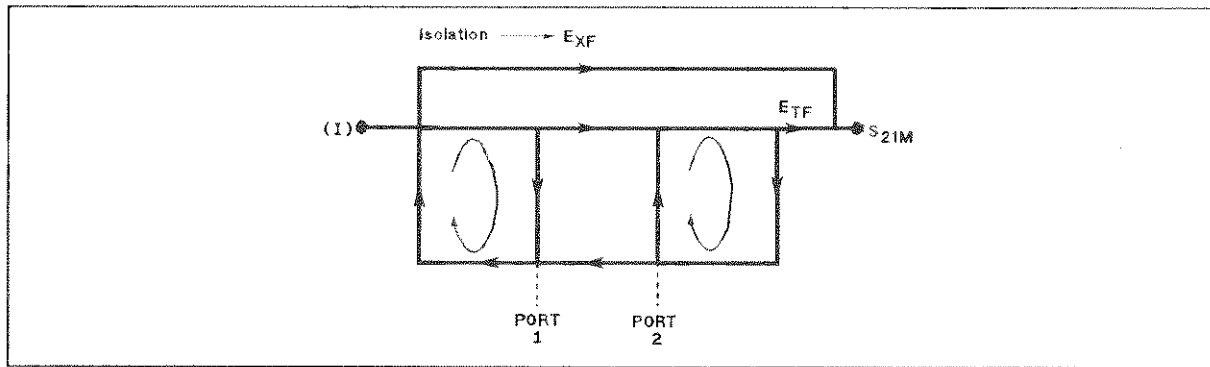

C2007058

Figure 7-38. Isolation E_{XF}

Error Terms the Analyzer Can Reduce. Thus there are two sets of error terms, forward and reverse, with each set consisting of six error terms, as follows:

- Forward
 - Directivity, E_{DF}
 - Isolation, E_{XF}
 - Source Match, E_{SF}
 - Load Match, E_{LF}
 - Transmission Tracking, E_{TF}
 - Reflection Tracking, E_{RF}
- Reverse
 - Directivity, E_{DR}
 - Isolation, E_{XR}
 - Source Match, E_{SR}
 - Load Match, E_{LR}
 - Transmission Tracking, E_{TR}
 - Reflection Tracking, E_{RR}

The HP 87511A/B S-parameter Test sets can measure both the forward and reverse characteristics of the test device without the need to manually remove and physically reverse it. With these test sets, the full two-port error model illustrated in Figure 7-39 effectively removes both the forward and reverse error terms for transmission and reflection measurements.

The HP 87512A/B Transmission/Reflection Test kits cannot switch between forward and reverse directions, so the reverse error terms cannot be automatically measured. Therefore, with the one-path two-port calibration, the forward error terms are duplicated and used for both forward and reverse measurements by manually reversing the test device.

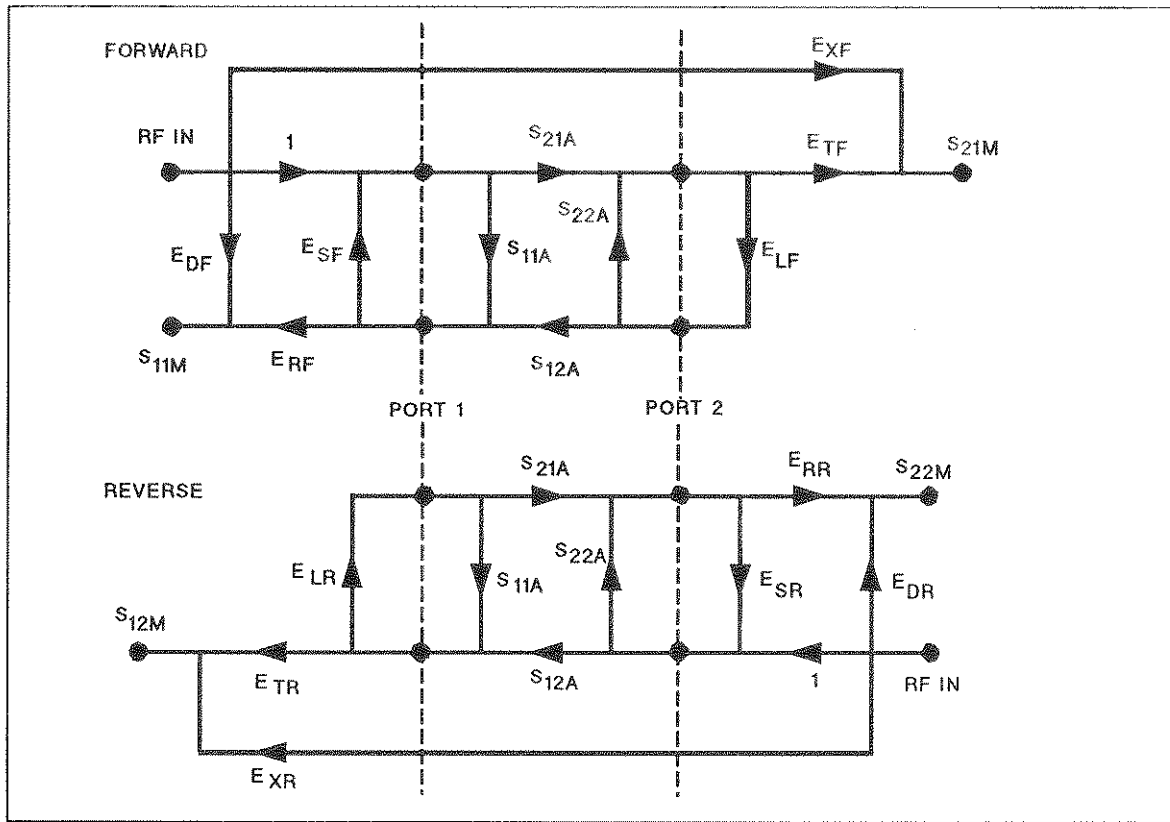

C2007059

Figure 7-39. Full Two-Port Error Model

The following equations show the full two-port error model equations for all four S-parameters of a two-port device. Note that the mathematics for this comprehensive model use all forward and reverse error terms and measured values. Thus, to perform full error correction for any one parameter, all four S-parameters must be measured.

Applications of these error models are provided in the calibration procedures described in Chapter 7.

$$S_{11A} = \frac{\left[\left(\frac{S_{11M} - E_{DF}}{E_{RF}} \right) \left[1 + \left(\frac{S_{22M} - E_{DR}}{E_{RR}} \right) E_{SR} \right] - \left[\left(\frac{S_{21M} - E_{XF}}{E_{TF}} \right) \left(\frac{S_{12M} - E_{XR}}{E_{TR}} \right) E_{LF} \right] \right]}{\left[1 + \left(\frac{S_{11M} - E_{DF}}{E_{RF}} \right) E_{SF} \right] \left[1 + \left(\frac{S_{22M} - E_{DR}}{E_{RR}} \right) E_{SR} \right] - \left[\left(\frac{S_{21M} - E_{XF}}{E_{TF}} \right) \left(\frac{S_{12M} - E_{XR}}{E_{TR}} \right) E_{LF} E_{LR} \right]}$$

$$S_{21A} = \frac{\left[1 + \left(\frac{S_{22M} - E_{DR}}{E_{RR}} \right) (E_{SR} - E_{LF}) \right] \left(\frac{S_{21M} - E_{XF}}{E_{TF}} \right)}{\left[1 + \left(\frac{S_{11M} - E_{DF}}{E_{RF}} \right) E_{SF} \right] \left[1 + \left(\frac{S_{22M} - E_{DR}}{E_{RR}} \right) E_{SR} \right] - \left[\left(\frac{S_{21M} - E_{XF}}{E_{TF}} \right) \left(\frac{S_{12M} - E_{XR}}{E_{TR}} \right) E_{LF} E_{LR} \right]}$$

$$S_{12A} = \frac{\left[1 + \left(\frac{S_{11M} - E_{DF}}{E_{RF}} \right) (E_{SF} - E_{LR}) \right] \left(\frac{S_{12M} - E_{XR}}{E_{TR}} \right)}{\left[1 + \left(\frac{S_{11M} - E_{DF}}{E_{RF}} \right) E_{SF} \right] \left[1 + \left(\frac{S_{22M} - E_{DR}}{E_{RR}} \right) E_{SR} \right] - \left[\left(\frac{S_{21M} - E_{XF}}{E_{TF}} \right) \left(\frac{S_{12M} - E_{XR}}{E_{TR}} \right) E_{LF} E_{LR} \right]}$$

$$S_{22A} = \frac{\left[\left(\frac{S_{22M} - E_{DR}}{E_{RR}} \right) \left[1 + \left(\frac{S_{11M} - E_{DF}}{E_{RF}} \right) E_{SF} \right] - \left[\left(\frac{S_{21M} - E_{XF}}{E_{TF}} \right) \left(\frac{S_{12M} - E_{XR}}{E_{TR}} \right) E_{LF} \right] \right]}{\left[1 + \left(\frac{S_{11M} - E_{DF}}{E_{RF}} \right) E_{SF} \right] \left[1 + \left(\frac{S_{22M} - E_{DR}}{E_{RR}} \right) E_{SR} \right] - \left[\left(\frac{S_{21M} - E_{XF}}{E_{TF}} \right) \left(\frac{S_{12M} - E_{XR}}{E_{TR}} \right) E_{LF} E_{LR} \right]}$$

In addition to the errors removed by accuracy enhancement, other systematic errors exist due to limitations of dynamic accuracy, test set switch repeatability, and test cable stability. These, combined with random errors, also contribute to total system measurement uncertainty. Therefore, after accuracy enhancement procedures are performed, residual measurement uncertainties remain.

Contents

8. Using Markers	
MKR KEY	8-1
MARKER MENU	8-4
Activate marker menu	8-5
Clear Marker Menu	8-6
Delta Marker Mode Menu	8-7
Delta Marker Menu	8-8
Fixed Marker Menu	8-9
Marker Mode Menu	8-10
Polar Marker Menu	8-11
Smith Marker Menu	8-12
MKR FCTN KEY	8-14
Marker Function Menu	8-15
Search Range Menu	8-16
Marker Search Menu	8-17
Target Menu	8-18
Marker Search More Menu	8-19
Note For Peak Define	8-20
Width Menu	8-21

Figures

8-1. Markers on Trace	8-1
8-2. Menus Accessed from the MKR Key	8-3
8-3. Marker Menu	8-4
8-4. Activate Marker Menu	8-5
8-5. Clear Marker Menu	8-6
8-6. Delta Marker Mode Menu	8-7
8-7. Delta Marker Menu	8-8
8-8. Fixed Marker Menu	8-9
8-9. Marker Mode Menu	8-10
8-10. Polar Marker Menu	8-11
8-11. Smith Marker Menu	8-12
8-12. Menus Accessed from the MKR FCTN Key	8-14
8-13. Marker Function Menu	8-15
8-14. Search Range Menu	8-16
8-15. Marker Search Menu	8-17
8-16. Target Menu	8-18
8-17. Marker Search More Menu	8-19
8-18. Peak Definition Example	8-20
8-19. Width Menu	8-21
8-20. Bandwidth Search Example	8-22

Using Markers

MKR KEY

The HP-IB programming command is shown in parenthesis following the key or softkey.

The **MKR** key displays a movable active marker (∇) on the screen and provides access to a series of menus to control one to eight display markers for each channel (a total of sixteen). Markers obtain numerical readings of measured values. They also provide capabilities for reducing measurement time by changing stimulus parameters, searching the trace for specific values, or statistically analyzing part or all of the trace. Figure 8-1 illustrates the displayed trace with all markers ON and marker 1 the active marker.

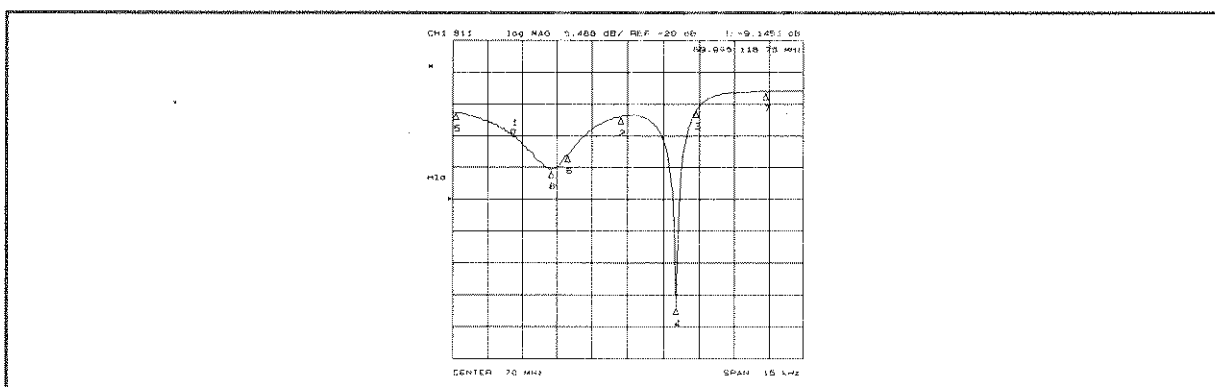

Figure 8-1. Markers on Trace

Markers have a stimulus value (the x-axis value in a Cartesian format) and a response value (the y-axis value in a Cartesian format). In a polar or Smith chart format, the second part of a complex data pair is also provided as an auxiliary response value. When a marker is turned on and no other function is active, its stimulus value is displayed in the active entry area and can be controlled with the knob, the step keys, or the numeric keypad. The active marker can be moved to any point on the trace, and its response and stimulus values are displayed at the top right corner of the graticule for each displayed channel, in units appropriate to the display format. The displayed marker response values are valid even when the measured data is above or below the range displayed on the graticule. When marker list is turned on, stimulus values and response values of all markers are listed on the graticule. When marker time mode is turned on, the x-axis is change to the time scale, which is the start point of the x-axis describes 0 second and the stop point indicates sweep time and markers have a time instead of a stimulus value. Marker values are normally continuous: that is, they are interpolated between measured points. Alternatively, they can be set to read only discrete measured points. The markers for the two channels normally have the same stimulus values, or they can be uncoupled so that each channel has independent markers, regardless of whether stimulus values are coupled or dual channel display is ON.

If both data and memory are displayed, you can select which marker values apply to the data trace or the memory trace. If one of data or memory is displayed, the marker values apply to the trace displayed. In a memory math display (data/memory or data-memory), the marker values apply to the trace resulting from the memory math function.

With the use of a reference marker, a delta marker mode is available that displays both the stimulus and response values of the active marker relative to the reference. Any of the eight markers or a fixed point can be designated as the delta reference marker. If the delta reference is one of the eight markers, its stimulus value can be controlled by the user and its response value is the value of the trace at that stimulus value. If the delta reference is a fixed marker, both its stimulus value and its response value can be set arbitrarily by the user anywhere in the display area (not necessarily on the trace). Markers can search for the trace maximum/minimum, mean point, any other point, peak maximum/minimum or peak-to-peak value of all or part of the trace. The eight markers can be used together to search for specified bandwidth cutoff points and calculate the bandwidth. Statistical analysis uses markers to provide a readout of the mean, standard deviation, and peak-to-peak values of all or part of the trace.

Basic marker operations are available in the menus accessed from the **MKR** key. The marker search and statistical functions, together with the capability for quickly changing stimulus parameters with markers, are provided in the menus accessed from the **MKR FCTN** key.

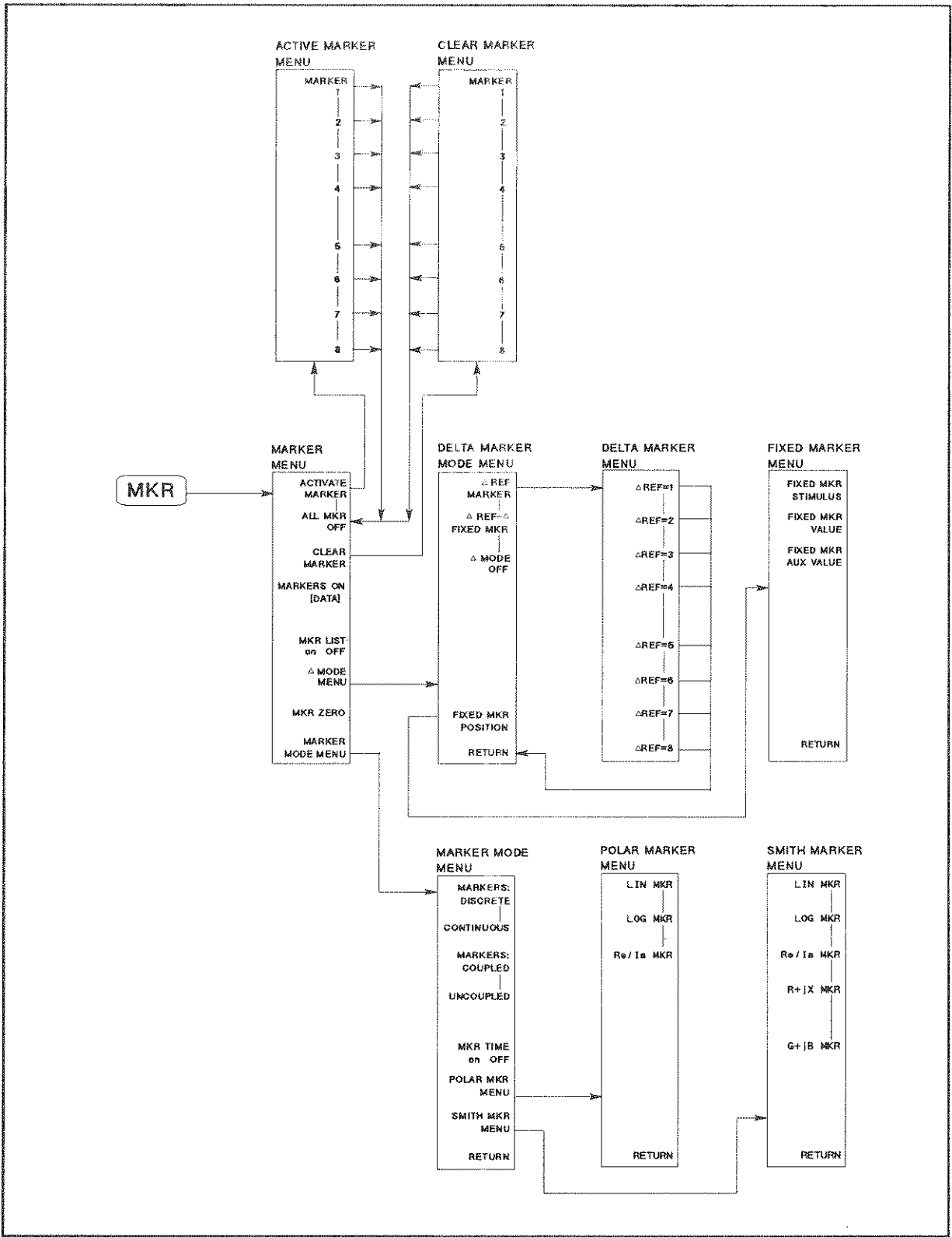

C2008017

Figure 8-2. Menus Accessed from the **(MKR)** Key

The menus accessed from the **(MKR)** key (Figure 8-2) provide several basic marker operations. These include different marker modes for different display formats, and the delta marker mode that displays marker values relative to a specified value.

MARKER MENU

The marker menu (Figure 8-3) goes to the activate marker menu or clear marker menu to turn the display markers ON or OFF, to make markers apply to data trace or memory trace, to list marker values, or to gain access to the marker delta mode and other marker modes and formats.

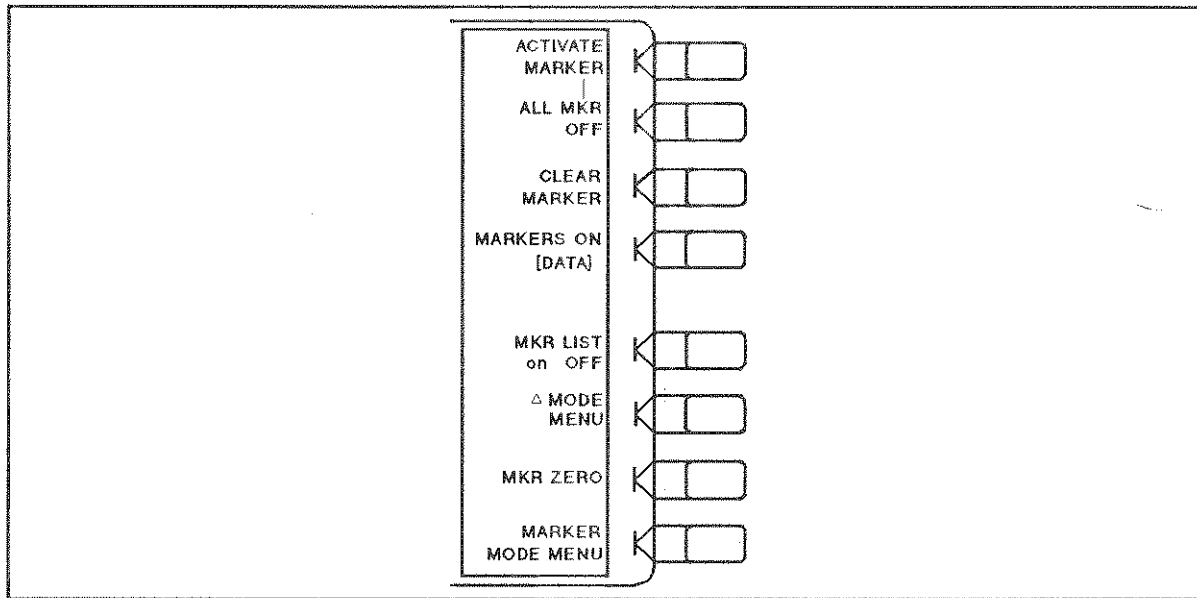

Figure 8-3. Marker Menu

ACTIVATE MARKER goes to the activate marker menu, which turns on a marker and make it the active marker.

ALL MKR OFF (MARKOFF) turns off all the markers and the delta reference marker, as well as the tracking and bandwidth functions that are accessed with the **(MKR FCTN)** key.

CLEAR MARKER goes to the clear marker menu, which turns off a marker.

MARKERS ON [DATA] (MARKODATA, MARKOMEMO) selects a trace from data or memory to be applied for the marker values. For the LOG MAG & PHASE or LOG MAG & DELAY formats, the data and memory trace denote LOG MAG and PHASE or DELAY, respectively.

MKR LIST on off (MARKLON, MARKLOFF) lists stimulus values and response values of all markers. In Δ mode, this lists all delta markers, and fixed markers.

Δ MODE MENU goes to the delta marker menu, which reads the difference in values between the active marker and a reference marker.

MKR ZERO (MARKZERO) puts a fixed reference marker at the present active marker position, and makes the fixed marker stimulus and response values at that position equal to zero. All subsequent stimulus and response values of the active marker are then read out relative to the fixed marker. The fixed marker is shown on the display as a small triangle “ Δ ” (delta), smaller than the inactive marker triangles. The softkey label changes from **MKR ZERO** to **MKR ZERO Δ REF = A** and the notation “ Δ REF=A” is displayed at the top right corner of the graticule. Marker zero is canceled by turning delta mode off in the delta marker menu or turning all the markers off with the **ALL MKR OFF** softkey.

MARKER MODE MENU provides access to the marker mode menu, where several marker modes can be selected including special markers for polar and Smith chart formats.

Activate marker menu

This menu (Figure 8-4) turns the display markers on and to designate the active marker.

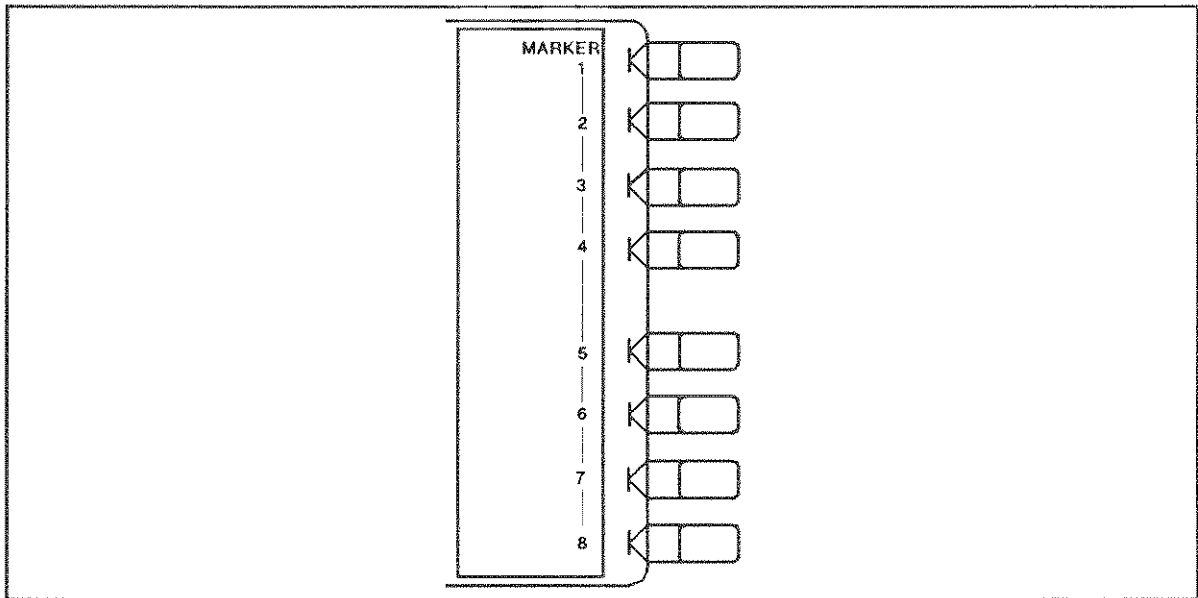

Figure 8-4. Activate Marker Menu

MARKER 1 (MARK1) turns on marker 1 and makes it the active marker. The active marker appears on the display as “ ∇ ”. The active marker stimulus value is displayed in the active entry area, together with the marker number. If there is a marker turned on, and no other function is active, the stimulus value of the active marker can be controlled with the knob, the step keys, or the numeric keypad. The marker response and stimulus values are displayed in the upper right-hand corner of the screen.

MARKER 2 (MARK2) turns on marker 2 and makes it the active marker. If another marker is present, that marker becomes inactive and is represented on the display as “ Δ ”.

MARKER 3 (MARK3) turns on marker 3 and makes it the active marker.

MARKER 4 (MARK4) turns on marker 4 and makes it the active marker.

MARKER 5 (MARK5) turns on marker 5 and makes it the active marker.

MARKER 6 (MARK6) turns on marker 6 and makes it the active marker.

MARKER 7 (MARK7) turns on marker 7 and makes it the active marker.

MARKER 8 (MARK8) turns on marker 8 and makes it the active marker.

Clear Marker Menu

This menu (Figure 8-5) turns the display markers Off. If an activated marker is cleared, the marker of smallest number, if any, will be activated.

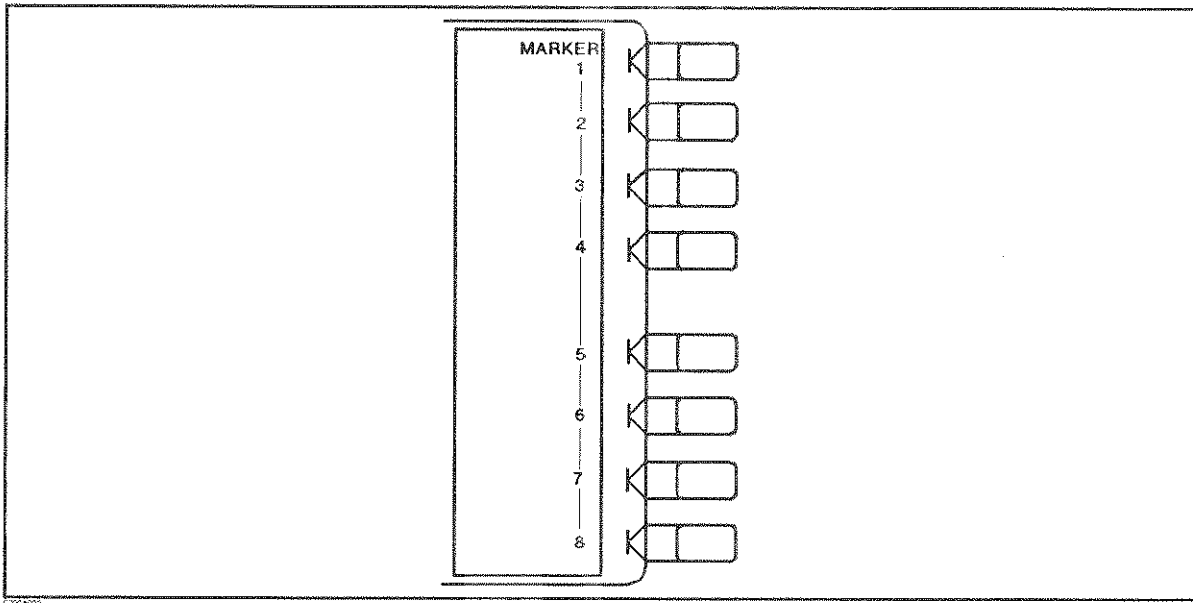

Figure 8-5. Clear Marker Menu

MARKER 1 (CLEM1) turns off marker 1.

MARKER 2 (CLEM2) turns off marker 2.

MARKER 3 (CLEM3) turns off marker 3.

MARKER 4 (CLEM4) turns off marker 4.

MARKER 5 (CLEM5) turns off marker 5.

MARKER 6 (CLEM6) turns off marker 6.

MARKER 7 (CLEM7) turns off marker 7.

MARKER 8 (CLEM8) turns off marker 8.

Delta Marker Mode Menu

The delta marker mode reads the difference in stimulus and response values between the active marker and a designated delta reference marker. Any of the eight markers or a fixed point can be designated as the reference marker. If the reference is one of the eight markers, its stimulus value can be controlled by the user and its response value is the value of the trace at that stimulus value. If the reference is a fixed marker, both its stimulus value and its response value can be set arbitrarily by the user anywhere in the display area. The delta reference is shown on the display as a small triangle Δ (delta), smaller than the inactive marker triangles (Δ). If one of the markers is the reference, the triangle appears next to the marker number on the trace.

The marker values displayed in this mode are the stimulus and response values of the active marker minus the reference marker. If the active marker is also designated as the reference marker, the marker values are zero.

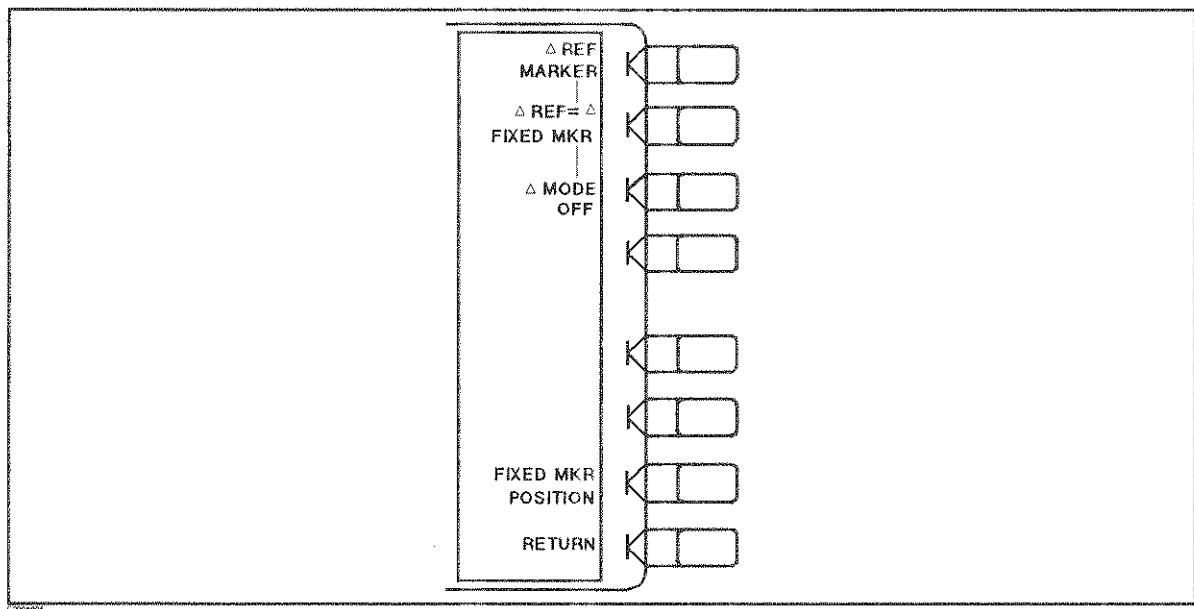

Figure 8-6. Delta Marker Mode Menu

Δ REF MARKER goes to the delta marker menu, which makes a marker the delta reference.

Δ REF= Δ FIXED MKR (DELRFIXM) sets a user-specified fixed reference marker. The stimulus and response values of the reference can be set arbitrarily, and can be anywhere in the display area. Unlike markers 1 to 8, the fixed marker need not be on the trace. The fixed marker is indicated by a small triangle Δ , and the active marker stimulus and response values are shown relative to this point. The notation " Δ REF= Δ " is displayed at the top right corner of the graticule.

Pressing this softkey turns on the fixed marker. Its stimulus and response values can then be changed using the fixed marker menu, which is accessed with the FIXED MKR POSITION softkey described below. Alternatively, the fixed marker can be set to the current active marker position, using the MKR ZERO softkey in the marker menu.

Δ MODE OFF (DELO) turns off the delta marker mode, so that the values displayed for the active marker are absolute values.

FIXED MKR POSITION leads to the fixed marker menu, where the stimulus and response values for a fixed reference marker can be set arbitrarily.

RETURN goes back to the marker menu.

Delta Marker Menu

This menu (Figure 8-7) establishes a marker as a delta reference. The active marker stimulus and response values are shown relative to this delta reference. If marker 1 has been selected as the delta reference, Δ REF=1 is underlined in this menu, and the marker menu is returned to the screen. In the activate marker menu under ACTIVATE MARKER, the first key is now labeled MARKER Δ REF = 1. The notation " Δ REF=1" appears at the top right corner of the graticule.

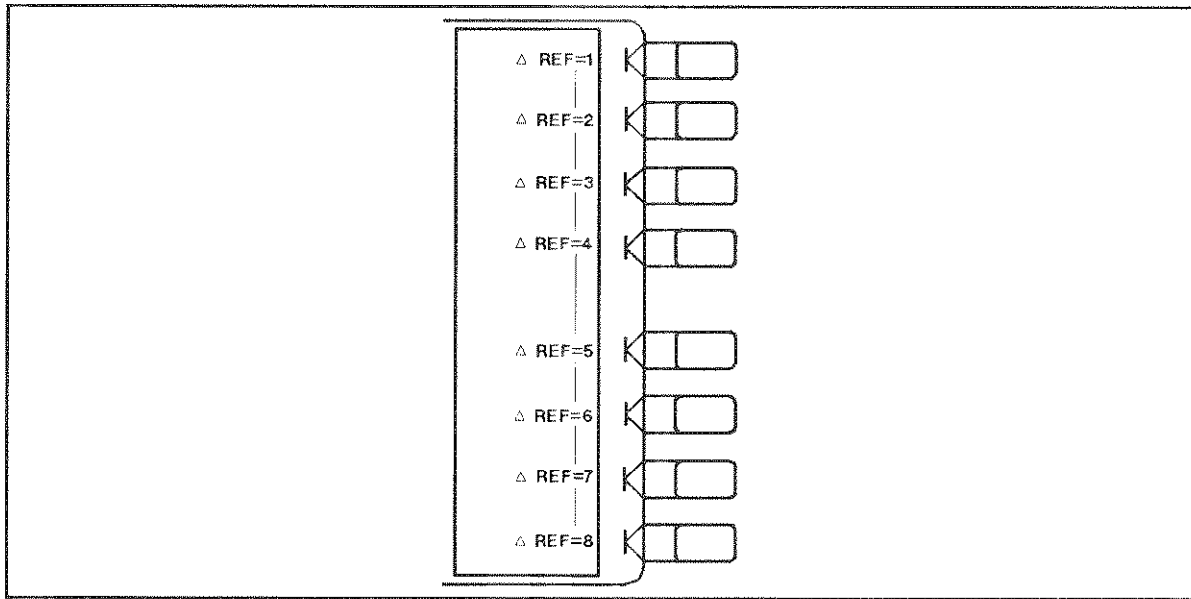

Figure 8-7. Delta Marker Menu

Δ REF = 1 (DELR1) makes marker 1 the delta reference.

Δ REF = 2 (DELR2) makes marker 2 the delta reference.

Δ REF = 3 (DELR3) makes marker 3 the delta reference.

Δ REF = 4 (DELR4) makes marker 4 the delta reference.

Δ REF = 5 (DELR5) makes marker 5 the delta reference.

Δ REF = 6 (DELR6) makes marker 6 the delta reference.

Δ REF = 7 (DELR7) makes marker 7 the delta reference.

Δ REF = 8 (DELR8) makes marker 8 the delta reference.

8-8 Using Markers

Fixed Marker Menu

This menu sets the position of a fixed reference marker, indicated on the display by a small triangle Δ . Both the stimulus value and the response value of the fixed marker can be set arbitrarily anywhere in the display area, and need not be on the trace. The units are determined by the display format, the sweep type, and the marker type.

There are two ways to turn on the fixed marker. One way is with the Δ REF = Δ FIXED MKR softkey in the delta marker mode menu. The other is with the MKR ZERO function in the marker menu, which puts a fixed reference marker at the present active marker position and makes the marker stimulus and response values at that position equal to zero.

The softkeys in this menu make the values of the fixed marker the active function. The marker readings in the top right corner of the graticule are the stimulus and response values of the active marker minus the fixed reference marker. Also displayed in the top right corner is the notation " Δ REF= Δ ".

The stimulus value, response value, and auxiliary response value (the second part of a complex data pair) can be individually examined and changed. This allows active marker readings that are relative in amplitude yet absolute in frequency, or any combination of relative/absolute readouts. Following a MKR ZERO operation, this menu can reset any of the fixed marker values to absolute zero for absolute readings of the subsequent active marker values.

If the format is changed while a fixed marker is ON, the fixed marker values become invalid. For example, if the value offset is set to 10 dB with a log magnitude format, and the format is then changed to phase, the value offset becomes 10 degrees. However, in polar, Smith, and inverse Smith chart formats, the specified values remain consistent between different marker types for those formats. Thus an R+jX marker set on a Smith chart format will retain the equivalent values if it is changed to any of the other Smith chart markers.

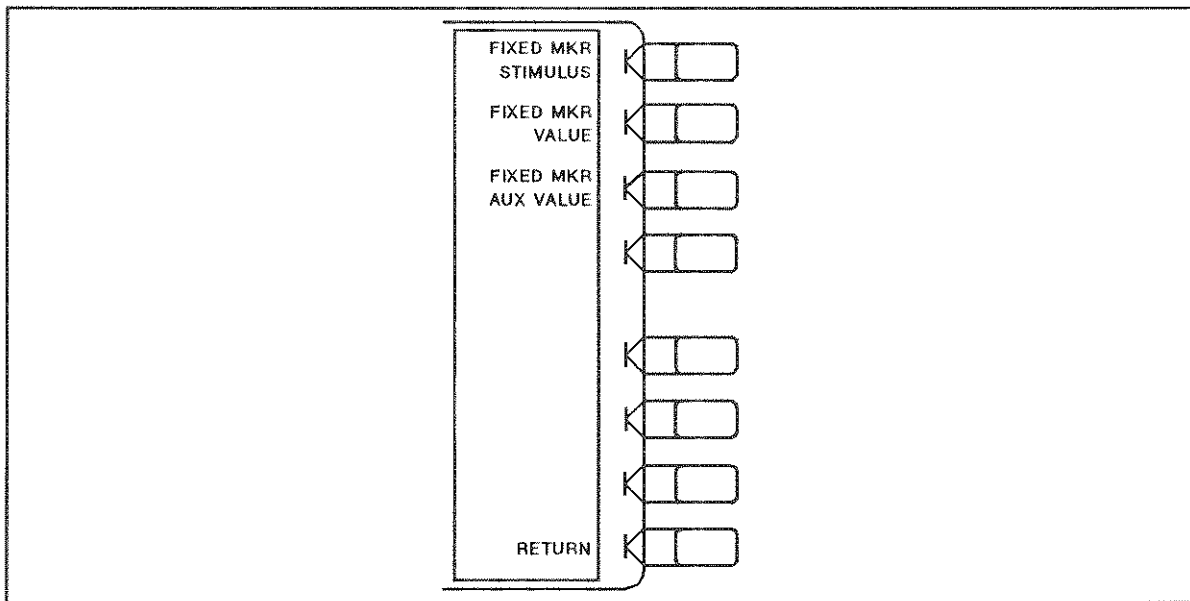

Figure 8-8. Fixed Marker Menu

FIXED MKR STIMULUS (MARKFSTI) changes the stimulus value of the fixed marker. Fixed marker stimulus values can be different for the two channels if the channel markers are uncoupled using the marker mode menu.

Absolute active marker stimulus values can be read, if the stimulus value is set to zero.

FIXED MKR VALUE (MARKFVAL) changes the response value of the fixed marker. In a Cartesian format this is the y-axis value. In a polar, Smith, or inverse Smith chart format with a magnitude/phase marker, a real/imaginary marker, an $R+jX$ marker, or a $G+jB$ marker, this applies to the first part (real part) of the complex data pair. Fixed marker response values are always uncoupled in the two channels.

Absolute active marker response values can be read, if the response value is set to zero.

FIXED MKR AUX VALUE (MARKFAUV) is used only with a polar, Smith, or inverse Smith format. It changes the auxiliary response value of the fixed marker. This is the second part (imaginary part) of a complex data pair, and applies to a magnitude/phase marker, a real/imaginary marker, an $R+jX$ marker, or a $G+jB$ marker. Fixed marker auxiliary response values are always uncoupled in the two channels.

Absolute active marker auxiliary response values can be read, if the auxiliary value is set to zero.

RETURN goes back to the delta marker mode menu.

Marker Mode Menu

This menu provides different marker modes and makes available two additional menus of special markers for use with a Smith chart or in polar formats.

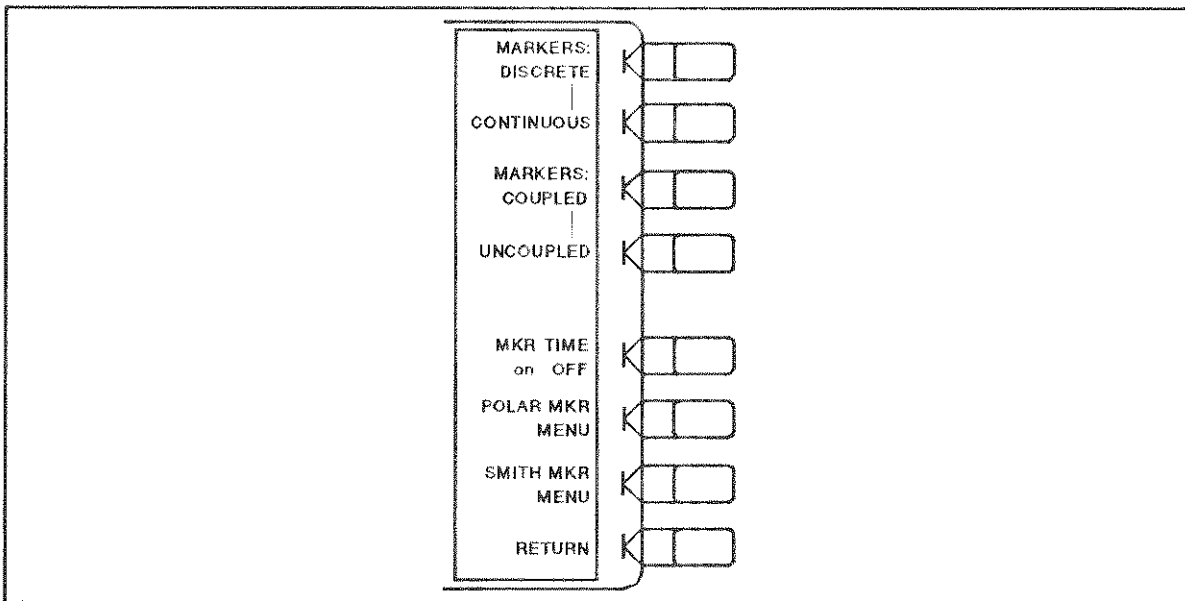

Figure 8-9. Marker Mode Menu

MARKERS: DISCRETE (MARKDISC) places markers only on measured trace points determined by the stimulus settings.

8-10 Using Markers

CONTINUOUS (MARKCONT) interpolates between measured points to allow the markers to be placed at any point on the trace. Displayed marker values are also interpolated. This is the default marker mode.

MARKERS: COUPLED (MARKCOUP) couples the marker stimulus values for the two display channels. Even if the stimulus is uncoupled and two sets of stimulus values are shown, the markers track the same stimulus values on each channel as long as they are within the displayed stimulus range.

UNCOUPLED (MARKUNCO) allows the marker stimulus values to be controlled independently on each channel.

MKR TIME on OFF (MARKTIMEON, MARKTIMEOFF) sets the x-axis units to time, where the start point is zero and the stop point is the value of the sweep time. A marker indicates the passed time after the sweep has started. This function is useful to test the DUT's time transition characteristics for certain fixed frequency by letting span zero.

POLAR MKR MENU leads to the polar marker menu.

SMITH MKR MENU leads to the Smith marker menu.

RETURN goes back to the marker menu.

Polar Marker Menu

This menu is used only with a polar display format, selectable using the **FORMAT** key. In a polar format, the magnitude at the center of the circle is zero and the outer circle is the full scale value set in the scale reference menu. Phase is measured as the angle counterclockwise from 0° at the positive x-axis. The analyzer automatically calculates different mathematical forms of the marker magnitude and phase values, selected using the softkeys in this menu. Marker frequency is displayed in addition to other values regardless of the selection of marker type.

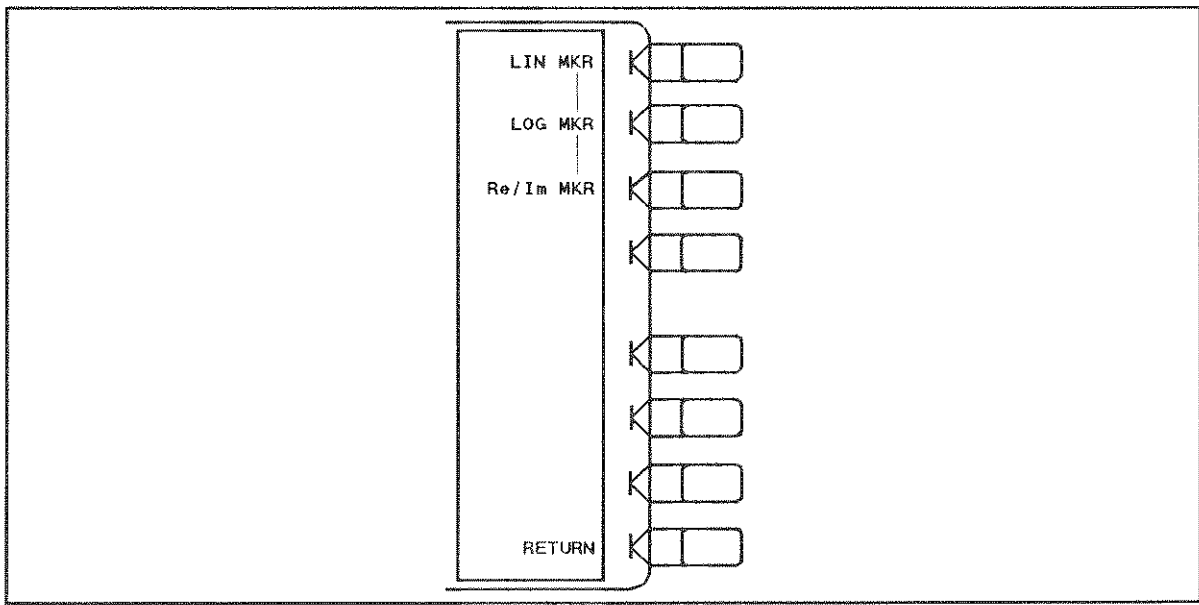

Figure 8-10. Polar Marker Menu

LIN MKR (POLMLIN) displays a readout of the linear magnitude and the phase of the active marker. This is the preset marker type for a polar display. Magnitude values are read in units and phase in degrees.

LOG MKR (POLMLOG) displays the logarithmic magnitude and the phase of the active marker. Magnitude values are expressed in dB and phase in degrees. This is useful as a fast method of obtaining a reading of the log magnitude value without changing to log magnitude format.

Re/Im MKR (POLMRI) displays the values of the active marker as a real and imaginary pair. The complex data is separated into its real part and imaginary part. The first marker value given is the real part ($= M \cos \theta$), and the second value is the imaginary part ($= M \sin \theta$), where M = magnitude.

RETURN goes back to the marker mode menu.

Smith Marker Menu

This menu is used only with a Smith or inverse Smith chart format, selected from the format menu. The analyzer automatically calculates different mathematical forms of the marker magnitude and phase values, selected using the softkeys in this menu. Marker frequency is displayed in addition to other values for all marker types.

For additional information about the Smith chart display format, refer to **FORMAT** Key.

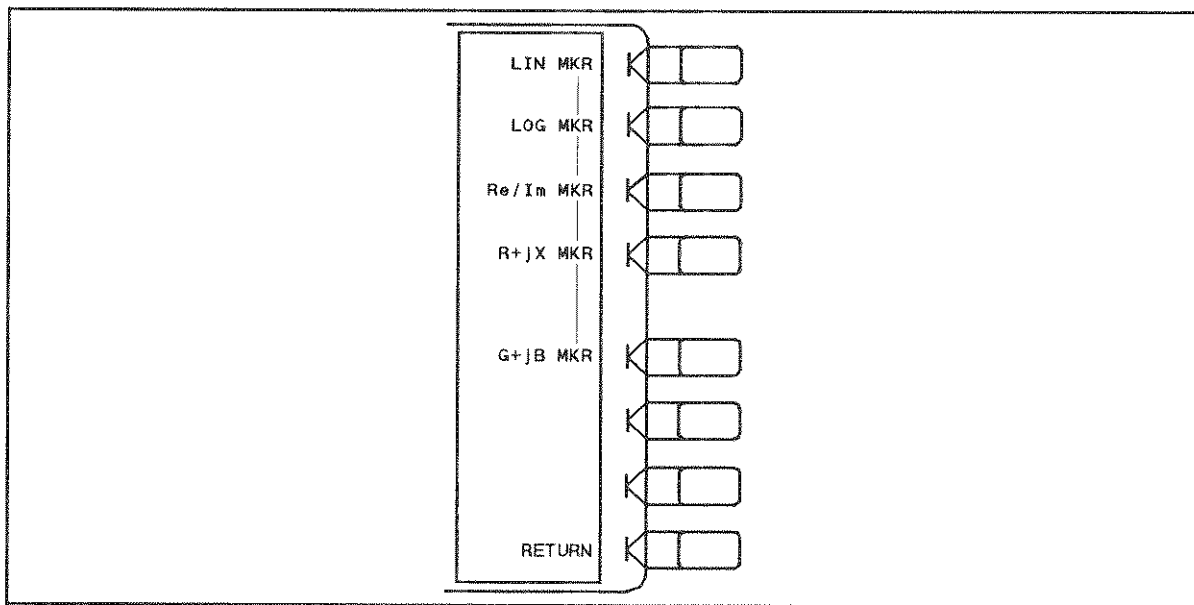

Figure 8-11. Smith Marker Menu

LIN MKR (SMIMLIN) displays a readout of the linear magnitude and the phase of the active marker. Marker magnitude values are expressed in units and phase in degrees.

LOG MKR (SMIMLOG) displays the logarithmic magnitude value and the phase of the active marker. Magnitude values are expressed in dB and phase in degrees. This is useful as a fast method of obtaining a reading of the log magnitude value without changing to log magnitude format.

Re/Im MKR (SMIMRI) displays the values of the active marker on a Smith chart as a real and imaginary pair. The complex data is separated into its real part and imaginary part. The first marker value given is the real part ($= M \cos \theta$), and the second value is the imaginary part ($= M \sin \theta$), where $M =$ magnitude.

R+jX MKR (SMIMRX) converts the active marker values into rectangular form. The complex impedance values of the active marker are displayed in terms of resistance, reactance, and equivalent capacitance or inductance. This is the default Smith chart marker.

The normalized impedance Z_0 for characteristic impedances other than 50Ω can be selected in "Calibrate More Menu" in Chapter 7 .

G+jB MKR (SMIMGB) displays the complex admittance values of the active marker in rectangular form. The active marker values are displayed in terms of conductance (in Siemens), susceptance, and equivalent capacitance or inductance. Siemens are the international units of admittance, and are equivalent to mhos (the inverse of ohms).

RETURN goes back to the marker mode menu.

MKR FCTN KEY

The HP-IB programming command is shown in parenthesis following the key or softkey.

The **MKR FCTN** (KEY 17) key activates a marker if one is not already active, and provides access to additional marker functions. These can quickly change the measurement parameters, to search the trace for specified information, and to analyze the trace statistically.

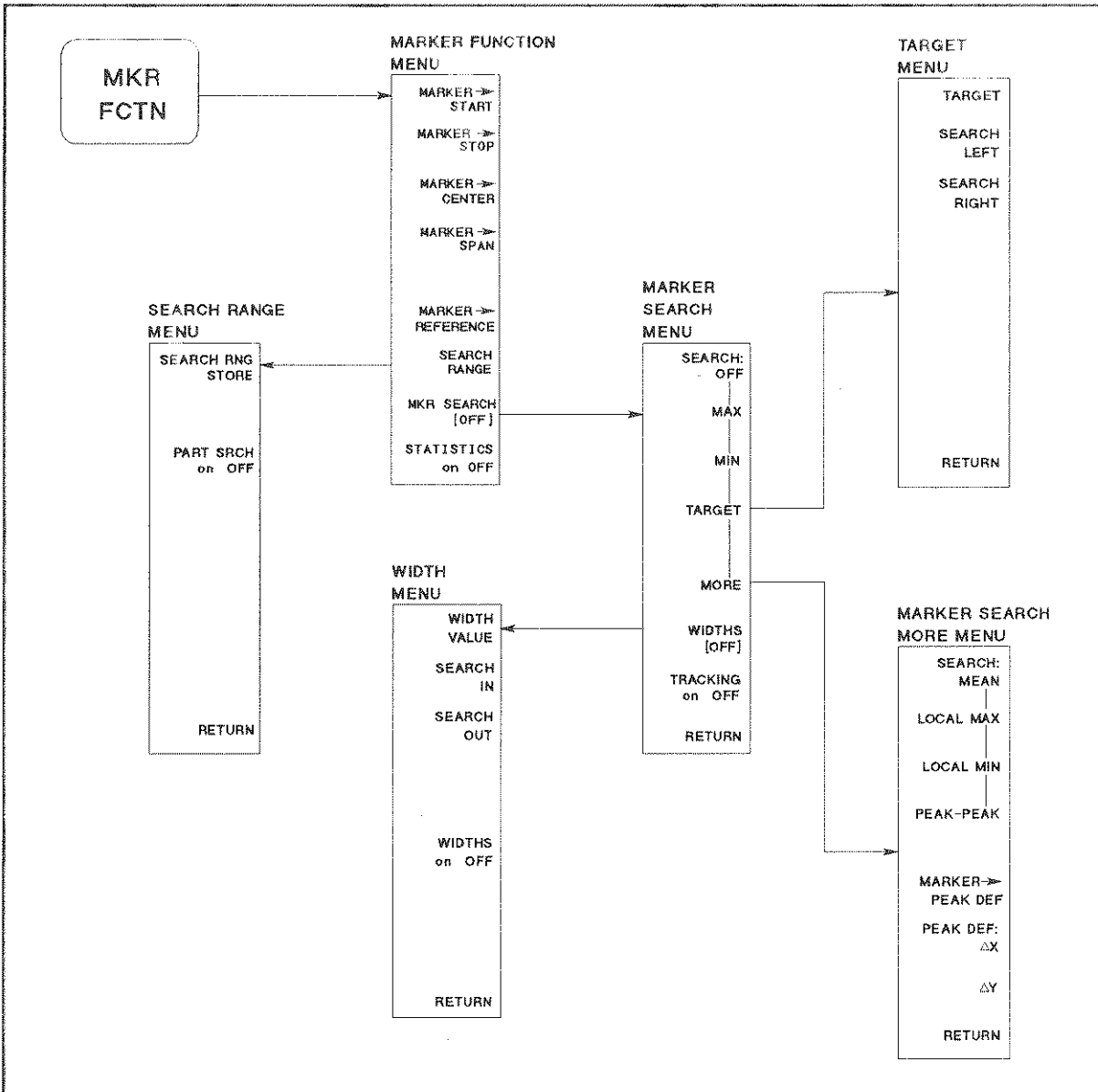

C2008018

Figure 8-12. Menus Accessed from the **MKR FCTN** Key

Marker Function Menu

This menu provides softkeys that use markers to quickly modify certain measurement parameters without going through the usual key sequence. In addition, it provides access to five additional menus used for searching the trace, for storing the search range, and for statistical analysis.

The **MARKER** → functions change certain stimulus and response parameters to make them equal to the current active marker value. Use the knob or the numeric keypad to move the marker to the desired position on the trace, and press the appropriate softkey to set the specified parameter to that trace value. When the values have been changed, the marker can again be moved within the range of the new parameters.

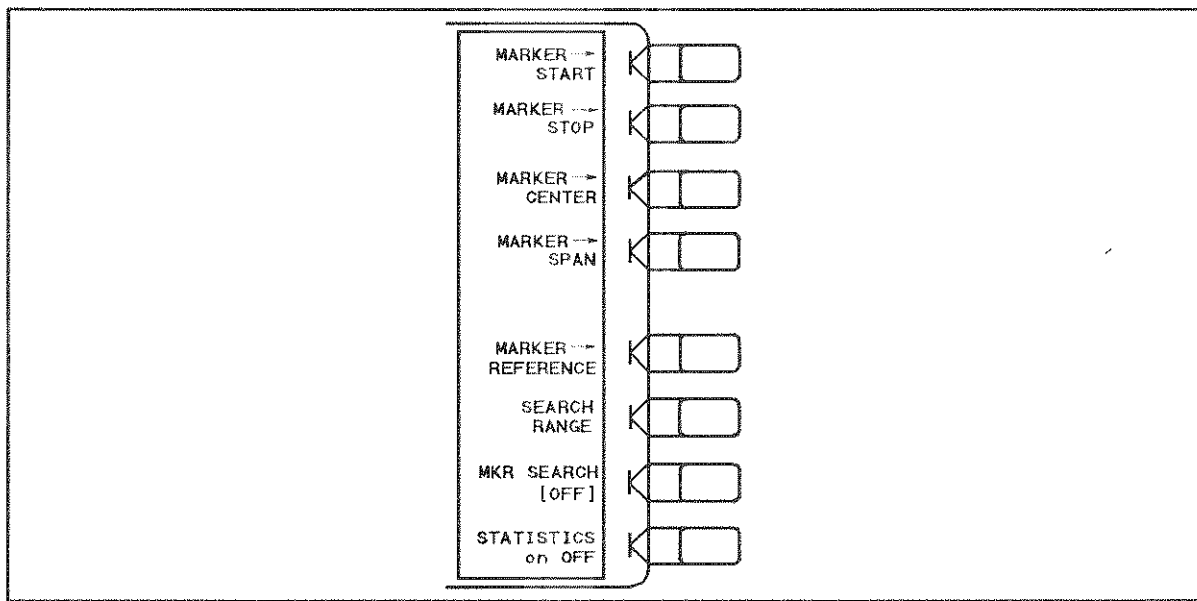

Figure 8-13. Marker Function Menu

MARKER → **START** (MARKSTAR) changes the stimulus start value to the stimulus value of the active marker.

MARKER → **STOP** (MARKSTOP) changes the stimulus stop value to the stimulus value of the active marker.

MARKER → **CENTER** (MARKCENT) changes the stimulus center value to the stimulus value of the active marker, and centers the new span about that value.

MARKER → **SPAN** (MARKSPAN) changes the start and stop values of the stimulus span to the values of the active marker and the delta reference marker. If there is no reference marker, the message "NO MARKER DELTA - SPAN NOT SET" is displayed.

MARKER → **REFERENCE** (MARKREF) equals the reference value to the active marker's response value, without changing the reference position. In a polar or Smith chart format, the full scale value at the outer circle is changed to the active marker response value. This softkey also appears in the scale reference menu.

SEARCH RANGE leads to the search range menu, which defines the range for partial search and to turn the partial search ON or OFF.

MKR SEARCH leads to the marker search menu, which searches the trace for a particular value or bandwidth.

STATISTICS (**MEASTATON**, **MEASTATOFF**) calculates and displays the mean, standard deviation, and peak-to-peak values of the section of the displayed trace in the search range defined in Search Range Menu. If Partial Search is OFF, the statistics are calculated for the entire trace. A convenient use of this feature is to find the peak-to-peak value of passband ripple without searching separately for the maximum and minimum values.

The statistics are absolute values: For polar and Smith chart formats the statistics are calculated using the first value of the complex pair (magnitude, real part, resistance, or conductance).

Search Range Menu

This menu specifies and activates the range which marker search functions are effective. This function is useful if a part of the entire stimulus range is analyzed.

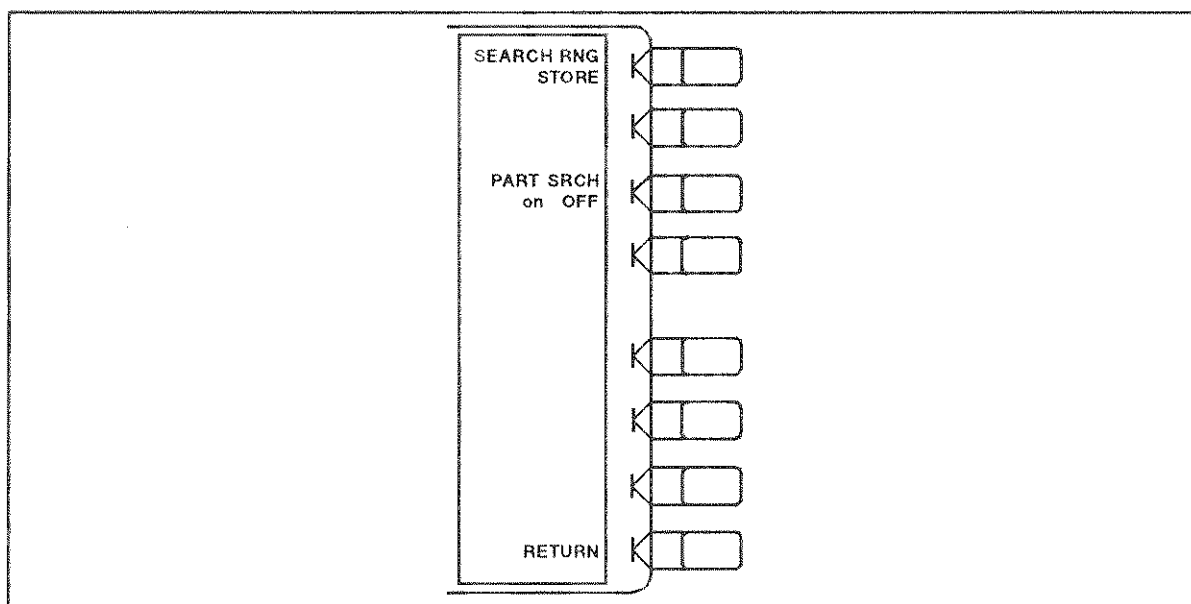

Figure 8-14. Search Range Menu

SEARCH RNG STORE (**SEARSTOR**) stores a search range, which is defined between the active marker and the delta reference marker. If there is no reference marker, the message "NO MARKER DELTA - RANGE NOT SET" is displayed.

PART SRCH on OFF (**PARSON**, **PARSOFF**) turns partial search ON or OFF. The search range is displayed by two small triangles, " Δ ", at the bottom of the graticule. If no search range is defined, the search range is the entire trace.

RETURN goes back to the marker function menu.

Marker Search Menu

This menu searches the trace for a specific amplitude-related point, and places the marker on that point, and to lead more menu for searching in a partial range of the trace. The capability of searching for a specified bandwidth is also provided. Tracking is available for a continuous sweep-to-sweep search. If there is no occurrence of a specified value or bandwidth, the message "TARGET VALUE NOT FOUND" is displayed.

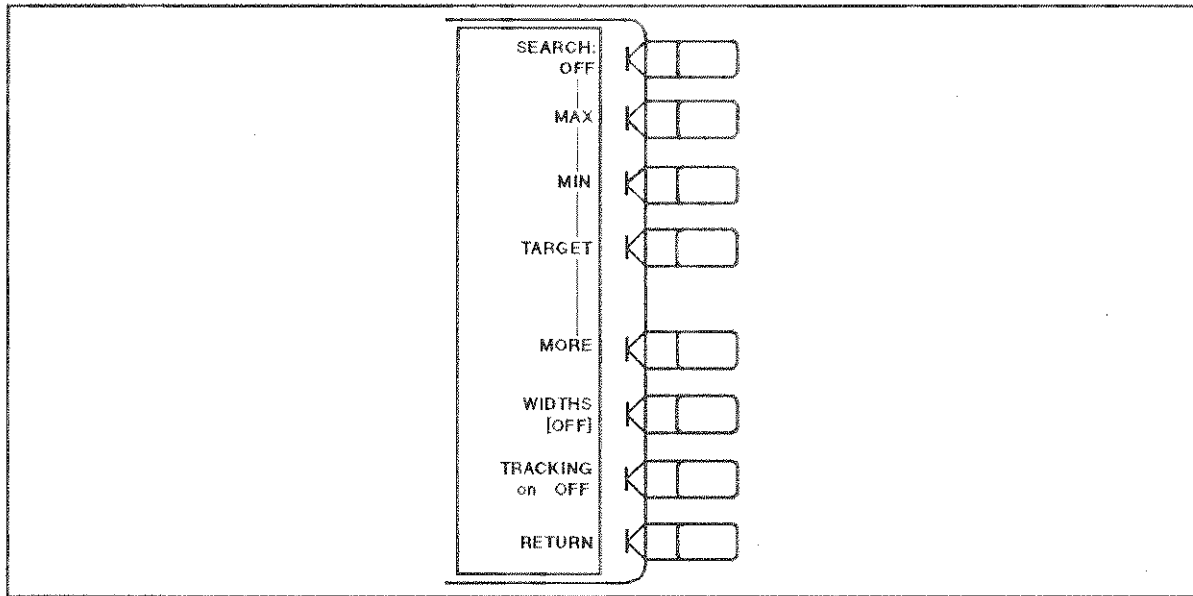

Figure 8-15. Marker Search Menu

SEARCH: OFF (SEAOFF) turns off the marker search function.

MAX (SEAMAX) moves the active marker to the maximum point on the trace. In Smith chart, inverse Smith chart, and polar format, LIN and LOG markers searches on $|\Gamma|$ and other types of marker searches on real part of measurement parameter.

MIN (SEAMIN) moves the active marker to the minimum point on the trace. In Smith chart, inverse Smith chart, and polar format, LIN and LOG markers searches on $|\Gamma|$ and other types of marker searches on real part of measurement parameter.

TARGET (SEATARG) places the active marker at a specified target point on the trace. The target menu is presented, providing search right and search left options to resolve multiple solutions.

For relative measurements, a search reference must be defined with a delta marker or a fixed marker before the search is activated.

MORE goes to the marker search more menu.

WIDTHS leads to width menu, which is used to define the start and stop points for a bandwidth search, and to turn bandwidth search ON and OFF.

TRACKING or **OFF** (TRACKON, TRACKOFF) is used in conjunction with other search features to track the search with each new sweep. Turning tracking ON makes the analyzer search every new trace for the specified target value and put the active marker on that point.

When tracking is OFF, the target is found on the current sweep and remains at the same stimulus value regardless of changes in trace response value with subsequent sweeps.

A maximum and a minimum point can be tracked simultaneously using two channels and uncoupled markers.

RETURN goes back to the marker function menu.

Target Menu

The target menu places the marker at a specified target response value on the trace, and provides search right and search left options. If there is no occurrence of the specified value, the message "TARGET VALUE NOT FOUND" is displayed.

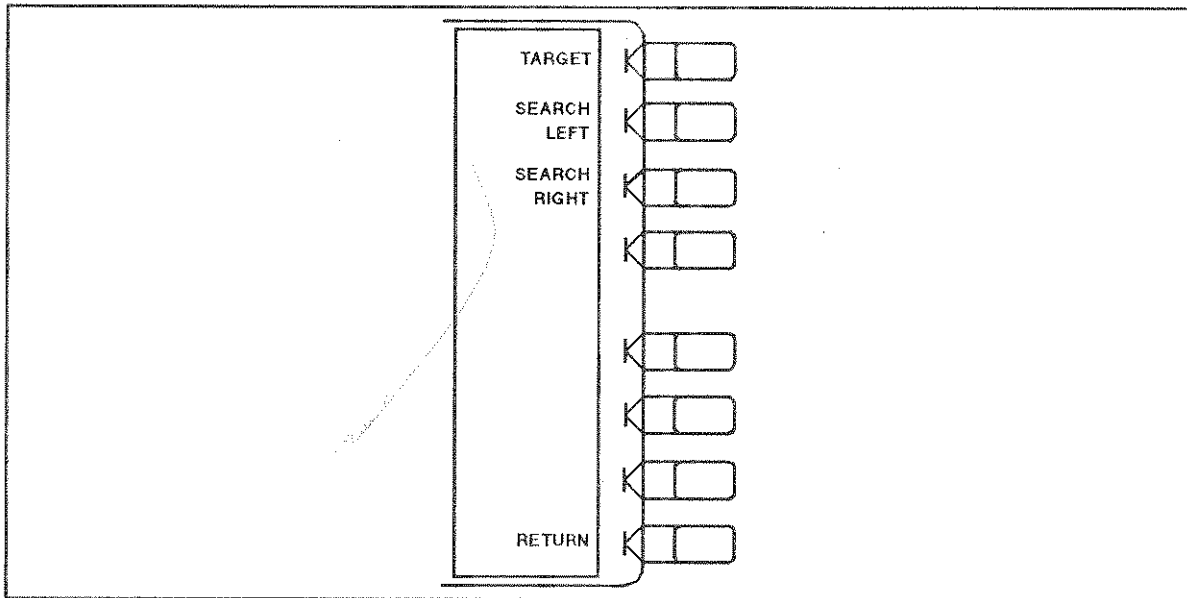

Figure 8-16. Target Menu

TARGET (SEATARG) places the marker at the specified target response value. If tracking is ON (see previous menu) the target is automatically tracked with each new trace. If tracking is OFF, the target is found each time this key is pressed. The target value is in units appropriate to the current format. The default target value is -3 dB.

In delta marker mode, the target value is the value relative to the reference marker. If no delta reference marker is ON, the target value is an absolute value.

SEARCH LEFT (SEAL) searches the trace for the next occurrence of the target value to the left.

SEARCH RIGHT (SEAR) searches the trace for the next occurrence of the target value to the right.

RETURN goes back to the marker search menu.

Marker Search More Menu

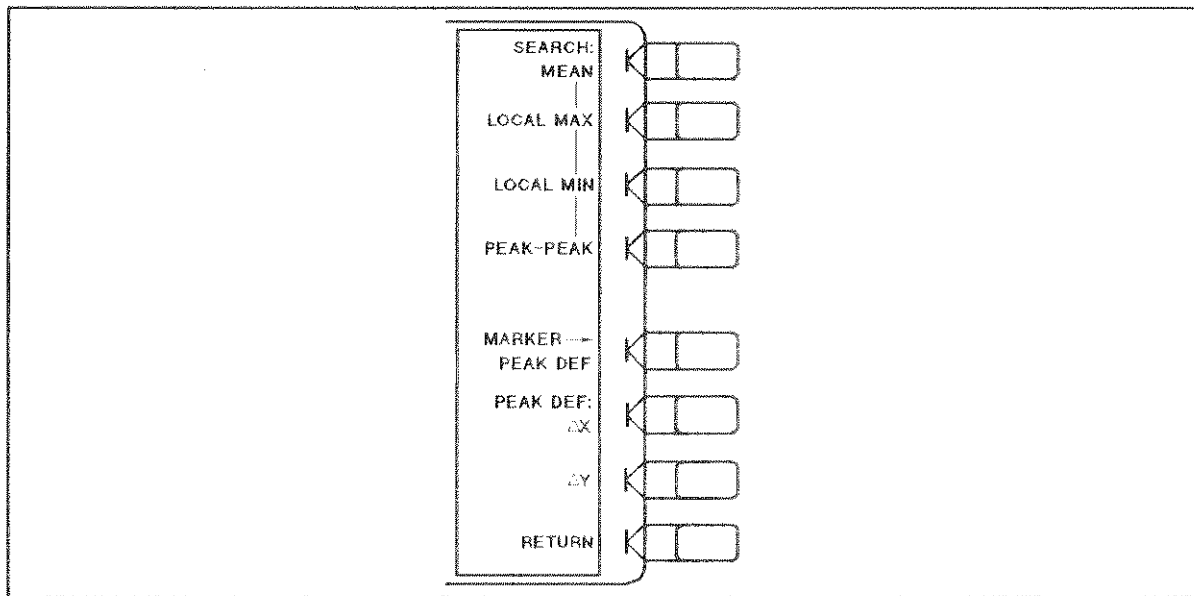

Figure 8-17. Marker Search More Menu

SEARCH: MEAN (SEAMEAN) moves the active marker to the mean point on the trace (in the search range if it has been specified).

LOCAL MAX (SEALMAX) moves the active marker to the maximum *peak* point on the trace in the search range stored in the search range menu. The applicable peak profile is defined by the **MARKER → PEAK DEF** or **PEAK DEF: ΔX** and **ΔY** keys described below.

LOCAL MIN (SEALMIN) moves the active marker to the minimum *peak* point on the trace in the search range stored in the search range menu. The applicable peak profile is defined by the **MARKER → PEAK DEF** or **PEAK DEF: ΔX** and **ΔY** keys described below.

PEAK-PEAK (SEAPPEAK) moves the active marker and the delta reference marker to the maximum peak point and the minimum peak point on the trace in the search range. The applicable peak profile is defined by the **MARKER → PEAK DEF** or **PEAK DEF: ΔX** and **ΔY** keys described below. This turns on the delta mode regardless of the current marker mode.

MARKER → PEAK DEF (MARKPEAD) changes the differential stimulus value (ΔX) and response value (ΔY) of the peak for searching for the local max, min, and peak-to-peak to the respective differential values between active and reference markers.

PEAK DEF: ΔX (PEADX) defines the differential stimulus value (ΔX) of the peak for searching for the local max, min, and peak-to-peak.

ΔY (PEADY) defines the differential response value (ΔY) of the peak for searching for the local max, min, and peak-to-peak.

Note For Peak Define

The PEAK DEF: ΔX and ΔY softkeys define the peak profile to be applicable for the LOCAL MAX, LOCAL MIN, and PEAK=PEAK functions. These functions search a peak where, the positive-going shoulder gradient is greater than ΔY/ΔX, and the negative-going shoulder gradient is less than -ΔY/ΔX. Therefore, the peak define function can limit the applicable peak to certain sharpness regardless its absolute value. The greater ΔY/ΔX, the sharper the peak.

Example: To analyze a spurious peak on a trace, shown in Figure 8-18, using the LOCAL MAX softkey, specify ΔY/ΔX, larger than that of the fundamental peak ΔY₁/ΔX₁, (expected not to be detected) and smaller than that of the spurious peak ΔY₂/ΔX₂ (expected to detect). This filters out the fundamental peak from the search.

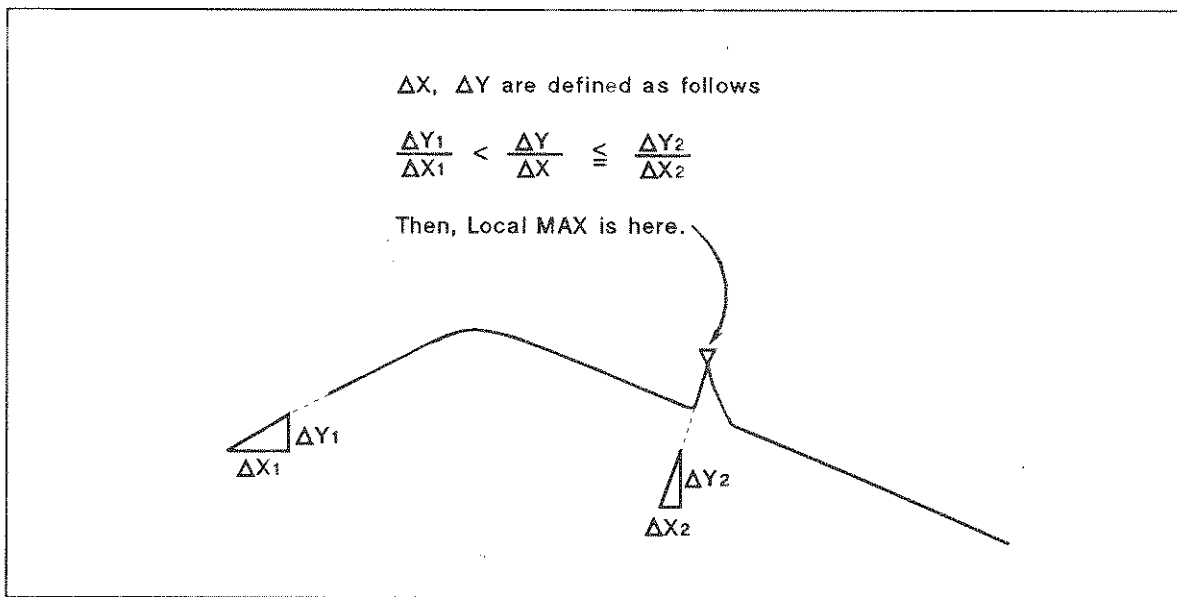

Figure 8-18. Peak Definition Example

The applicable peak is only specified by the ratio, Δx/Δy. The absolute values of Δx and Δy do not matter.

RETURN goes back to the marker search menu.

Width Menu

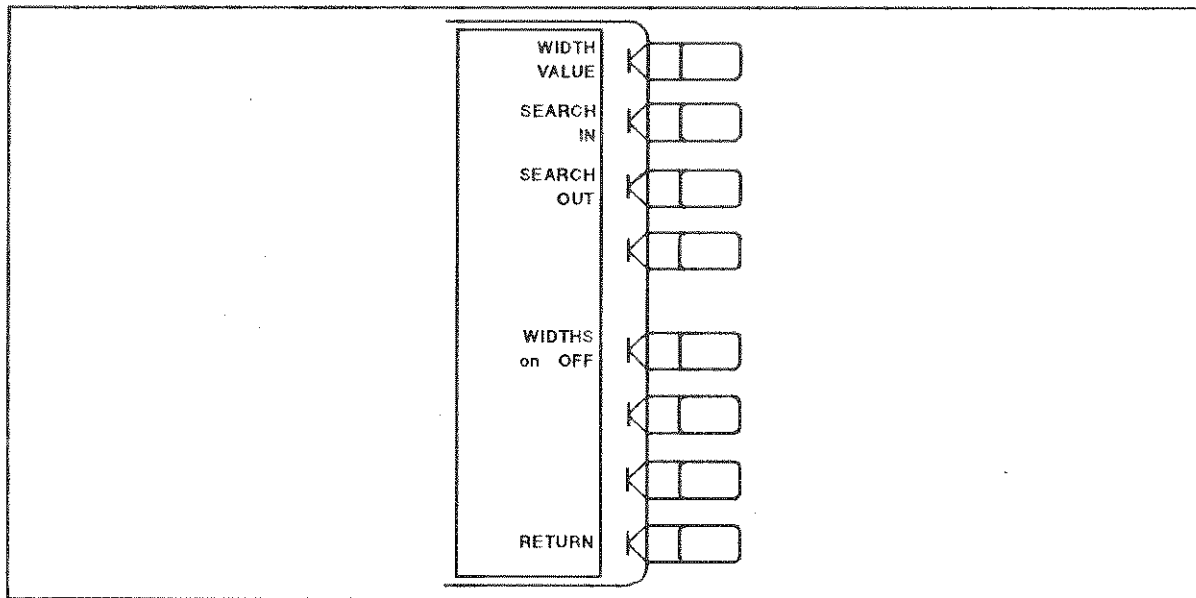

Figure 8-19. Width Menu

WIDTH VALUE (WIDV) sets the amplitude parameter (for example -3 dB) that defines the start and stop points for a bandwidth search. The bandwidth search feature analyzes a bandpass or band reject trace and calculates the center point, bandwidth, and Q (quality factor) for the specified bandwidth. Bandwidth units are in the units of the current format. When Δ mode is ON, the bandwidth value specified is deference from the delta reference.

SEARCH IN (WIDSIN) searches for the cutoff point on the trace within the current cutoff points.

SEARCH OUT (WIDSON) searches for the cutoff point on the trace outside of the current cutoff points.

WIDTHS on OFF (WIDTON, WIDTOFF) turns on the bandwidth search feature and calculates the center stimulus value, bandwidth, Q, insertion loss, and cutoff point deviation from the center of a bandpass or band reject shape on the trace. The amplitude value that defines the passband or rejectband is set using the **WIDTH VALUE** softkey.

When **WIDTHS** is turned on, if the active marker is 1, 2, 3, or 4, markers 1, 2, 3, and 4 are turned on, and each is assigned to a dedicated use. Marker 1 is the starting point from which the search is begun. Marker 2 is the bandwidth center point. Marker 3 is the bandwidth cutoff point on the left, and marker 4 is the cutoff point on the right. If the active marker is the 5, 6, 7, or 8, markers 5, 6, 7, and 8 move in the same manner as above for markers 1, 2, 3, and 4.

The width parameters obtained are also listed on the display as follows:

BW displays the bandwidth value set by the **WIDTH VALUE** softkey.
cent displays the center stimulus value between cutoff points, which is marked by the marker 2 (, or 6).

- Q displays the Q value (= cent/BW) of the trace.
- Insertion Loss displays the absolute value of the marker 1 (, or 5).
- ΔF (left) displays the stimulus value difference between markers 3 (or 5) and center frequency specified by **CENTER** key.
- ΔF (right) displays the stimulus value difference between markers 4 (or 8) and center frequency specified by **CENTER** key.

Figure 8-20 shows an example of the bandwidth search feature.

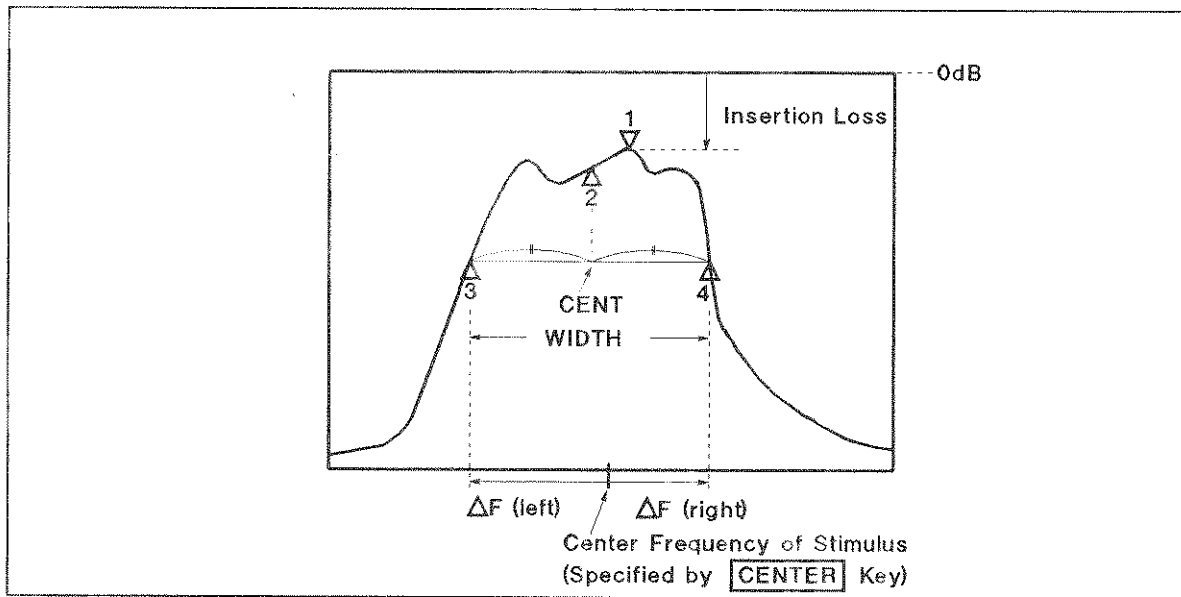

Figure 8-20. Bandwidth Search Example

If a delta marker or fixed marker is ON, it is used as the reference point from which the bandwidth amplitude is measured. For example, if marker 1 is the delta marker and is set at the passband maximum, and the width value is set to -3 dB, the bandwidth search finds the bandwidth cutoff points 3 dB below the maximum and calculates the 3 dB bandwidth and Q.

If marker 2 (the dedicated bandwidth center point marker) is the delta reference marker, the search finds the points 3 dB down from the center.

If no delta reference marker is set, the bandwidth values are absolute values.

In the expanded phase mode, this function searches the two cutoff points whose values are "+WIDTH VALUE", and "-WIDTH VALUE". For example, when the width value is 45° , the cutoff points' values are $\pm 45^\circ$.

RETURN goes back to the marker search menu.

Contents

9. Instrument State Function Block	
INTRODUCTION	9-1
INSTRUMENT STATE FUNCTIONS AND WHERE THEY ARE DESCRIBED	9-2
LOCAL Key	9-3
Local Lockout	9-3
HP-IB Menu	9-3
System Controller Mode	9-4
Addressable Mode	9-4
Address Menu	9-5
SYSTEM KEY	9-7
System Menu	9-7
Clock Menu	9-8
Set Time Menu	9-9
Set Date Menu	9-10
LIMIT LINE AND LIMIT TESTING	9-11
How Limit Lines are Entered	9-13
Turning Limit Lines Limit Testing On and Off	9-14
Segments Entering Order Needs Notice	9-14
Saving the Limit Line Table	9-14
Offsetting the Stimulus or Amplitude of the Limit Lines	9-14
Supported Display Formats	9-14
Use a Sufficient Number of Points or Errors May Occur	9-15
Displaying, Printing, or Plotting Limit Test Data	9-15
Results of Plotting or Printing the Display with Limit Lines ON	9-15
Limits Menu	9-16
Edit Limits Menu	9-17
Edit Segment Menu	9-18
Clear List Menu	9-20
Offset Limit Menu	9-21
INSTRUMENT BASIC (OPTION 002)	9-21

Figures

9-1. Instrument State Function Block	9-1
9-2. Softkey Menus Accessed from the LOCAL Key	9-3
9-3. HP-IB Menu	9-4
9-4. Address Menu	9-6
9-5. System Menu	9-7
9-6. Softkey Menus Accessed from the SET CLOCK Softkey	9-8
9-7. Clock Menu	9-8
9-8. Set Time Menu	9-9
9-9. Set Date Menu	9-10
9-10. Softkey Menus Access from the LIMIT MENU softkey.	9-12
9-11. The Concept of Segments as a Point between Two Sets of Limit Lines	9-13
9-12. Limits Menu	9-16
9-13. Edit Limits Menu	9-18
9-14. Edit Segment Menu	9-19
9-15. Clear List Menu	9-20
9-16. Offset Limit Menu	9-21

Tables

9-1. Instrument State Function Descriptions	9-2
9-2. Default HP-IB Addresses	9-5

Instrument State Function Block

INTRODUCTION

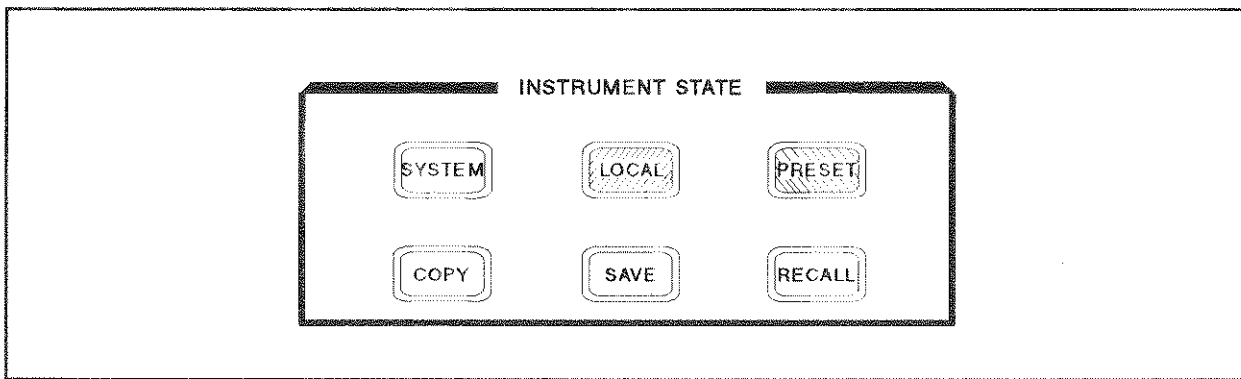

C2009001

Figure 9-1. Instrument State Function Block

The instrument state function block keys and associated menus provide control of channel-independent system functions. These include controller modes, instrument addresses, real time clock, limit lines and limit testing, Instrument BASIC (Option 002), plotting or printing, saving instrument states and trace data on a built-in disk.

INSTRUMENT STATE FUNCTIONS AND WHERE THEY ARE DESCRIBED

Functions accessible in the instrument state function block are described in several different chapters of this Reference, and in other manuals.

Table 9-1 lists each function and where it is discussed. Unless otherwise noted, all references are in this Reference and are marked with the acronym "REF".

Table 9-1. Instrument State Function Descriptions

Instrument State Key	Function	Chapter or Manual
(SYSTEM)	Instrument BASIC Clock Limit Lines and Limit Testing Service Menu	<i>HP Instrument BASIC Manual Set</i> Using HP Instrument BASIC with the HP 8751A This Chapter This Chapter <i>Maintenance Manual</i>
(COPY)	All Features - including printing and plotting	Chapter 10, REF
(SAVE)	All Features - including saving instrument states and saving to external disk.	Chapter 11, REF
(RECALL)	All Features - including recall of instrument state and data from built-in disk drive.	Chapter 11, REF
(LOCAL)	All features - including HP-IB and address menus.	This Chapter
(PRESET)	Preset State	Appendix A, REF

LOCAL Key

LOCAL key leads to the following menus:

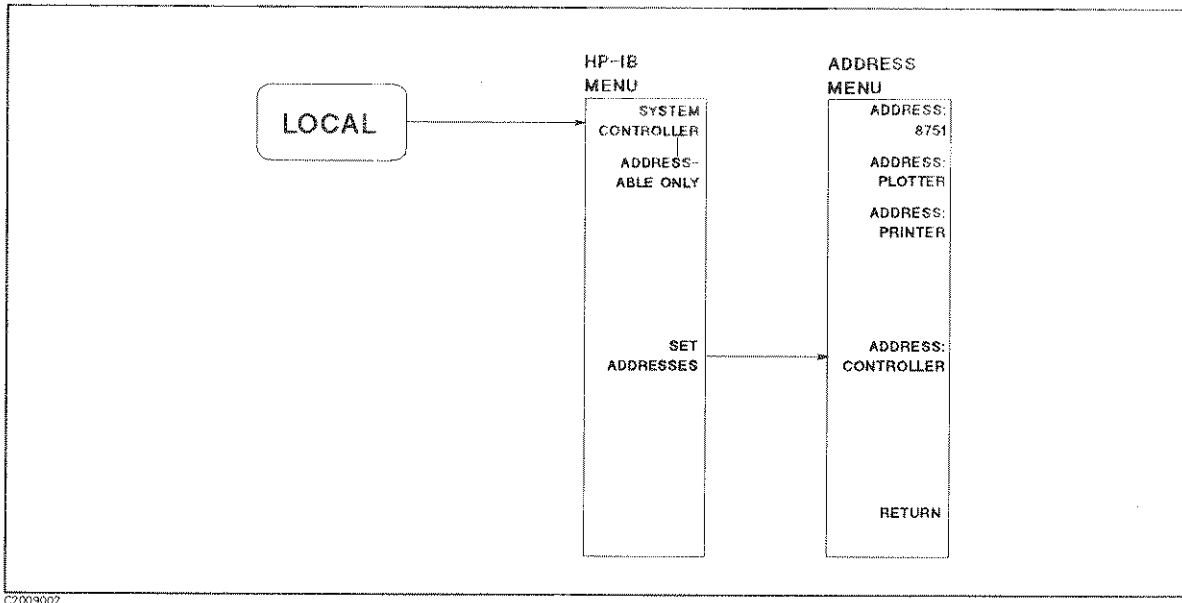

Figure 9-2. Softkey Menus Accessed from the **LOCAL** Key

This key performs the following functions:

- Returns front panel control to the user. The instrument ignores all front panel keys (except the local key) when under the control of an external computer. The instrument is in “local mode” when the user has front panel control. The instrument is in the “remote mode” when an external computer controls the instrument.
- Gives access to the HP-IB menu, which sets the controller mode, and to the address menu, where the HP-IB addresses of peripheral devices are entered. The controller mode determines which device controls the HP-IB bus, the instrument or computer. Only one of them can control the bus at a time.

Local Lockout

Local lockout is a remote (computer generated) command that disables the **LOCAL** key, making it impossible to interfere with the instrument (except for the Power Switch) while it is under computer control.

HP-IB Menu

The analyzer is factory-equipped with a remote programming interface using the Hewlett-Packard Interface Bus (HP-IB). This enables communication between the analyzer and a controlling computer as well as other peripheral devices. This menu indicates the present HP-IB controller mode of the analyzer. Two HP-IB modes are possible: system controller and addressable only.

Preset does not affect the selected controller mode, but cycling the power returns the analyzer to the addressable only mode.

Information on usable peripherals is provided in the *General Information* section of this manual.

System Controller Mode

In the system controller mode, the analyzer itself can use HP-IB to control usable peripherals, without the use of an external computer. For example, the analyzer can output measurement results directly to a usable printer or plotter.

Addressable Mode

This is the mode of operation most often used. In this mode, a computer can take control to communicate with the analyzer and other peripherals on the bus. The computer can send commands or instructions to and receive data from the analyzer. All of the capabilities available from the analyzer front panel can be used in this operation mode. Exceptions are some special functions such as internal tests.

Information on HP-IB operation is provided in Chapter 12 and in the *HP-IB Programming Manual*.

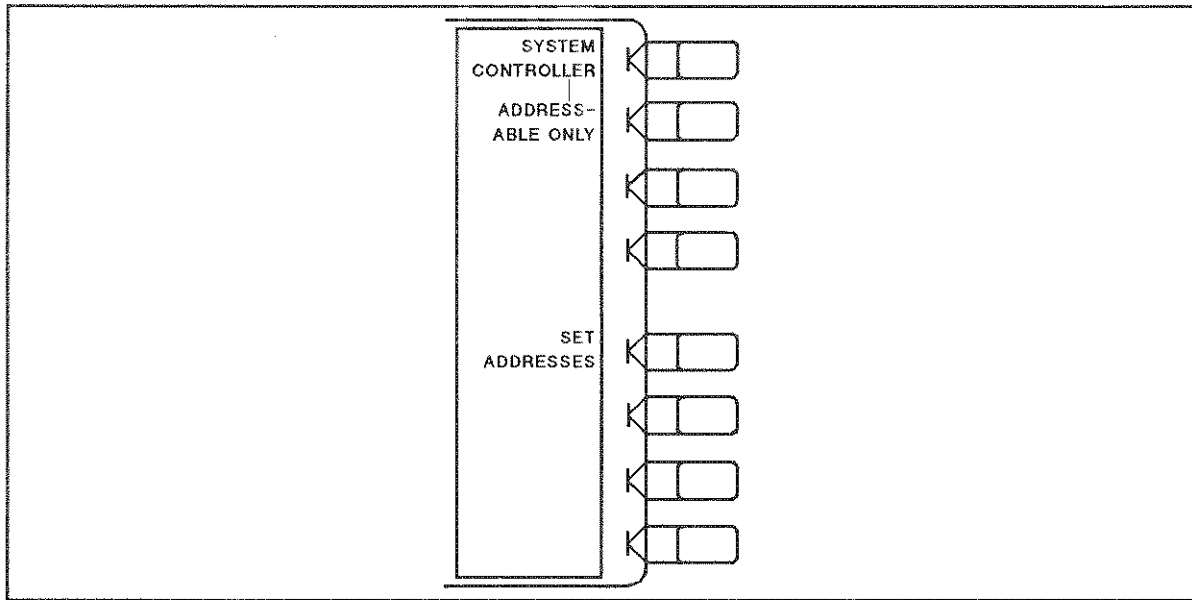

Figure 9-3. HP-IB Menu

SYSTEM CONTROLLER is the mode used when peripheral devices are to be used and there is no external controller. Refer to the description above.

The system controller mode can be used without knowledge of HP-IB programming. However, the HP-IB address must be entered for each peripheral device.

This mode can only be selected manually from the analyzer's front panel, and can be used only if no active system controller is connected to the system through HP-IB. If you try to set system controller mode when another system controller is present, the message "CAUTION: CAN'T CHANGE - ANOTHER CONTROLLER ON BUS" is displayed.

9-4 Instrument State Function Block

ADDRESSABLE ONLY is the mode used when an external controller controls peripheral devices or the analyzer. This mode is also used when the external computer passes control of the bus to the analyzer.

SET ADDRESSES goes to the address menu, which sets the HP-IB address of the analyzer, and to display and modify the addresses of peripheral devices in the system.

Address Menu

In communications through the Hewlett-Packard Interface Bus (HP-IB), each instrument on the bus is identified by an HP-IB address. This decimal-based address code must be different for each instrument on the bus.

This menu sets the HP-IB address of the analyzer. It also sets the HP-IB addresses the analyzer will use when talking to each peripheral.

Most of the HP-IB addresses are set at the factory and need not be modified for normal system operation. The standard factory-set addresses for instruments that may be part of the system are as follows:

Table 9-2. Default HP-IB Addresses

Instrument	HP-IB Address (decimal)
Analyzer	17
Plotter	05
Printer	01
Controller	21

The address displayed in this menu for each peripheral device must match the address set on the device itself. If the addresses do not match, they can be matched in one of two ways. Either the address set in the analyzer can be changed using the entry controls; or the address of the device can be changed using instructions provided in its manual. The analyzer's HP-IB address is changed through the keyboard controls, there is no physical HP-IB switch.

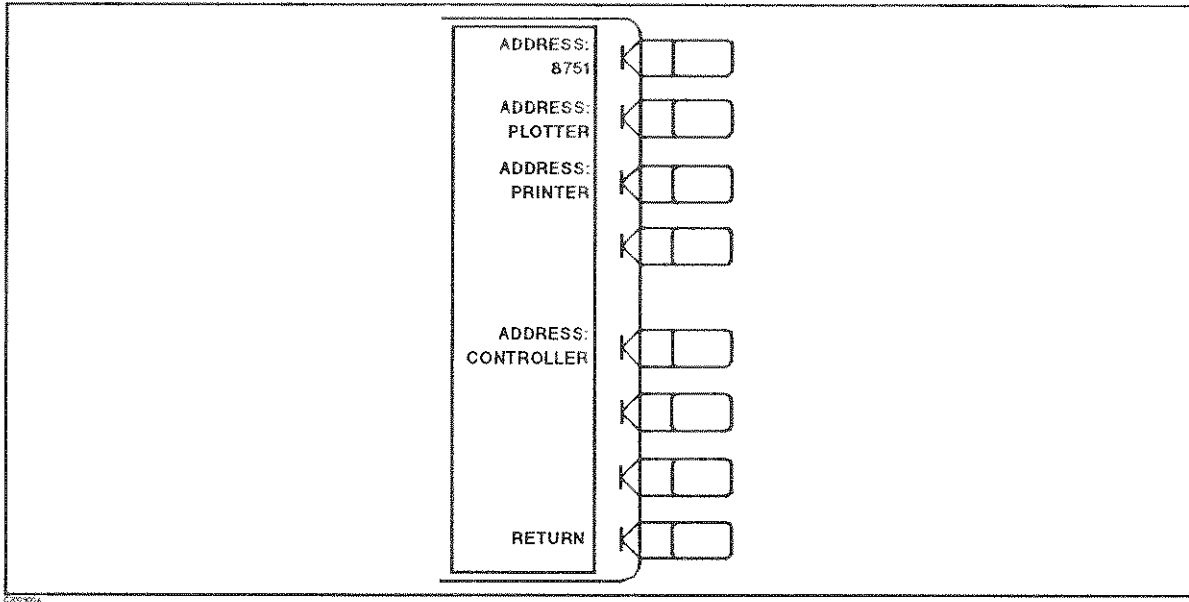

Figure 9-4. Address Menu

ADDRESS: 8751 sets the HP-IB address of the analyzer, using the entry controls. There is no physical address switch to set in the analyzer.

ADDRESS: PLOTTER (ADDRPLOT) sets the HP-IB address the analyzer will use to communicate with the plotter.

ADDRESS: PRINTER (ADDRPRIN) sets the HP-IB address the analyzer will use to communicate with the printer.

ADDRESS: CONTROLLER (ADDRCONT) sets the HP-IB address the analyzer will use to communicate with the external controller.

RETURN goes back to the HP-IB menu.

SYSTEM KEY

The HP-IB programming command is shown in parenthesis following the key or softkey. This key presents the system menu.

System Menu

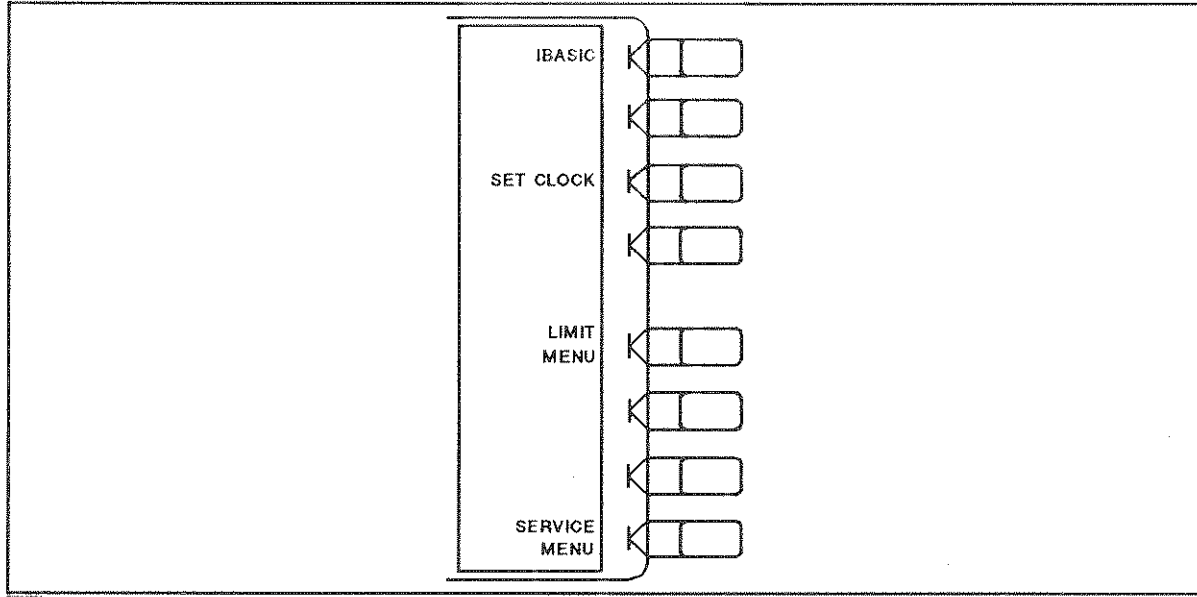

Figure 9-5. System Menu

IBASIC leads to a series of menus used to operate Instrument BASIC. Refer to “INSTRUMENT BASIC (OPTION 002)” in this chapter. This softkey will not appear if the analyzer is not equipped with Option 002.

SET CLOCK leads to a series of menus as shown in Figure 9-6, which sets an internal clock. Refer to “Clock Menu” in this chapter.

LIMIT MENU leads to a series of menus as shown in Figure 9-10, which defines limits or specifications with which to compare a test device. Refer to “LIMIT LINE AND LIMIT TESTING”.

SERVICE MENU leads to a series of service menus described in detail in the *Maintenance Manual*.

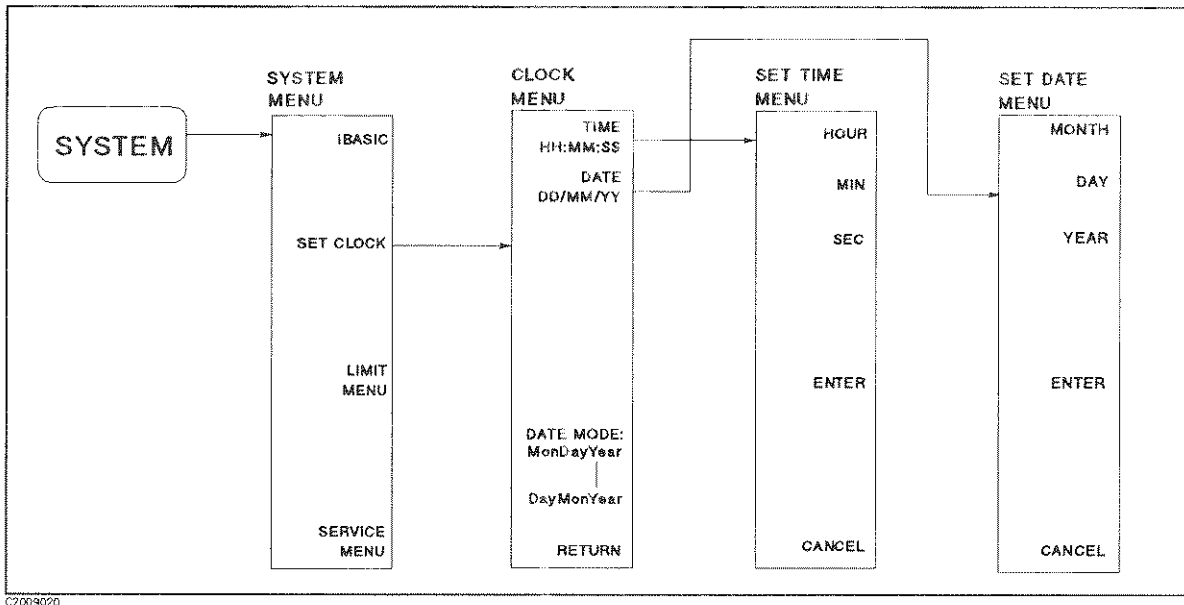

Figure 9-6. Softkey Menus Accessed from the SET CLOCK Softkey

Clock Menu

This menu is used to print the current time and date. When the analyzer prints or plots the data, the current time and date is printed or plotted before the information on the screen, if COPY TIME under the COPY key is turned ON.

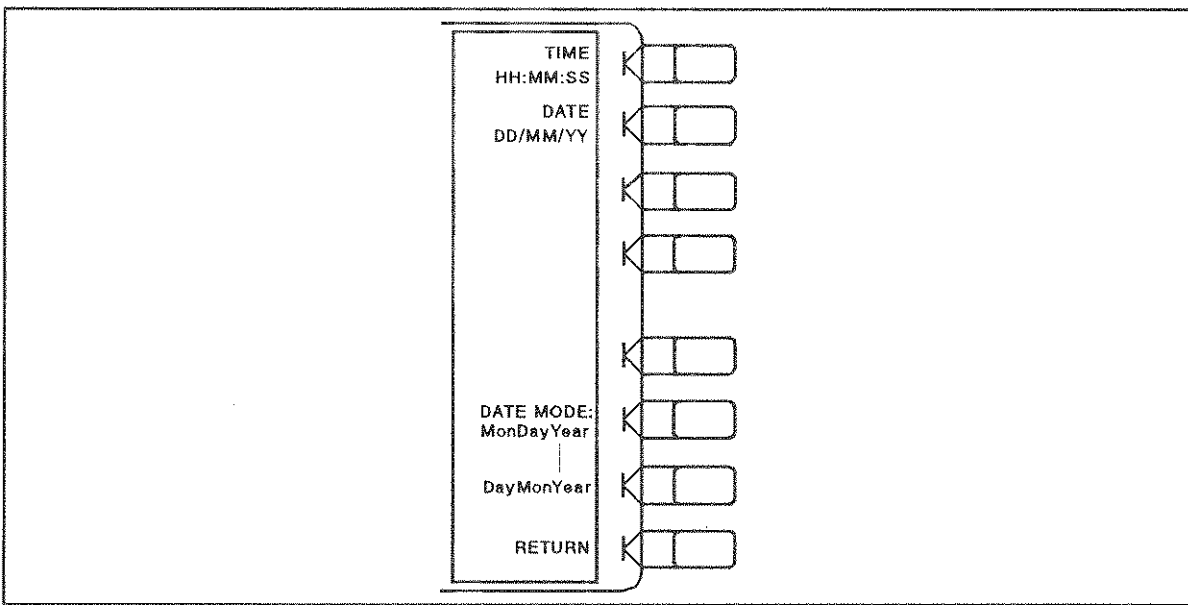

Figure 9-7. Clock Menu

TIME HH:MM:SS (SETCTIME) displays the current time when pressed. To adjust the time, refer to “Set Time Menu”.

9-8 Instrument State Function Block

DATE MM/DD/YY (SETCDATE) displays the current date when pressed. To adjust the date, refer to “Set Date Menu”.

DATE MODE: MonDayYear (MONDYEAR) changes the displayed date to the “month:day:year” format.

DayMonYear (DAYMYEAR) changes the displayed date to the “day:month:year” format.

RETURN returns to the system menu.

Set Time Menu

This menu is used to set the internal clock.

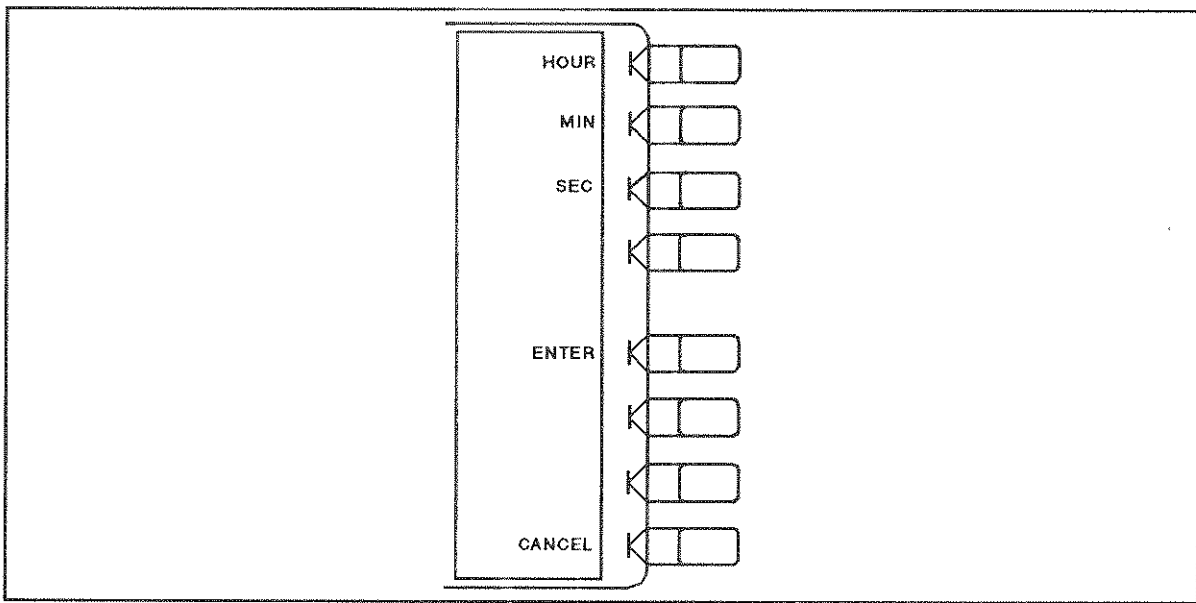

Figure 9-8. Set Time Menu

HOUR enables changing the hour setting using the knob or the numeric entry keys. After you change the hour setting, press **ENTER** to restart the clock.

MIN enables changing the minute setting using the knob or the numeric entry keys. After you change the minute setting, press **ENTER** to restart the clock.

SEC enables changing the second setting using the knob or the numeric entry keys. After you change the second setting, press **ENTER** to restart the clock.

ENTER restarts the internal clock.

CANCEL returns to the clock menu. Pressing this key will not affect the internal clock setting.

Set Date Menu

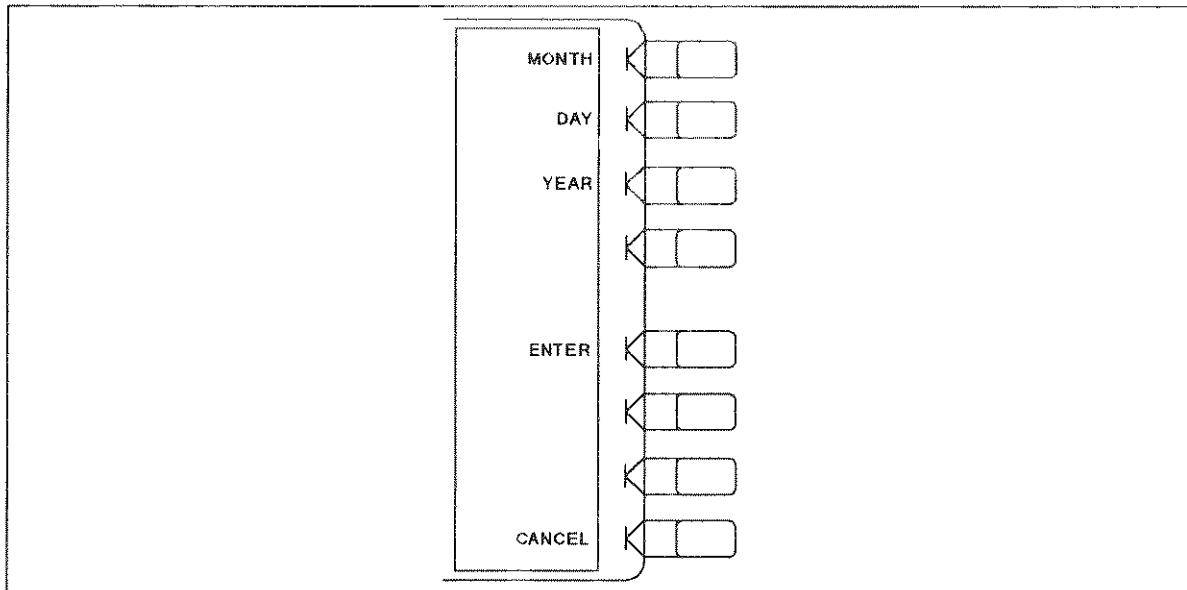

Figure 9-9. Set Date Menu

MONTH enables changing the month setting using the knob or the numeric entry keys. After you change the month setting, press **ENTER** to restart the clock.

DAY enables changing the day setting using the knob or the numeric entry keys. After you change the day setting, press **ENTER** to restart the clock.

YEAR enables changing the year setting using the knob or the numeric entry keys. After you change the year setting, press **ENTER** to restart the clock.

ENTER restarts the internal clock.

CANCEL returns to the clock menu. Pressing this key will not affect the internal clock setting.

LIMIT LINE AND LIMIT TESTING

These are lines drawn on the display to represent upper and lower limits or device specifications with which to compare the device under test. Limits are defined by specifying several segments, where each segment is a portion of the stimulus span. Each limit segment has an upper and a lower starting limit value.

Limits can be defined independently for the two channels, up to 18 segments for each channel (a total of 36 for both channels). These can be in any combination of the two limit types.

Limit testing compares the measured data with the defined limits, and provides pass or fail information for each measured data point. An out-of-limit test condition is indicated in the following ways:

- Displaying a FAIL message on the screen
- Emitting a beep
- Displaying an asterisk in tabular listings of data
- Writing bit in HP-IB event status register B
- Writing LOW-status of PASS/FAIL signal line of the I/O port on the analyzer rear panel. Refer to Appendix C.

Limits are entered in tabular form. Limit lines and limit testing can be either ON or OFF while limits are defined. As new limits are entered, the tabular columns on the display are updated, and the limit lines (if on) are modified to the new definitions. The complete limit set can be offset in either stimulus or amplitude value.

An example of a measurement using limit lines and limit testing is provided in *the User's Guide*.

The series of menus for defining limits are accessed using the **SYSTEM** key. These menus are illustrated in Figure 9-10.

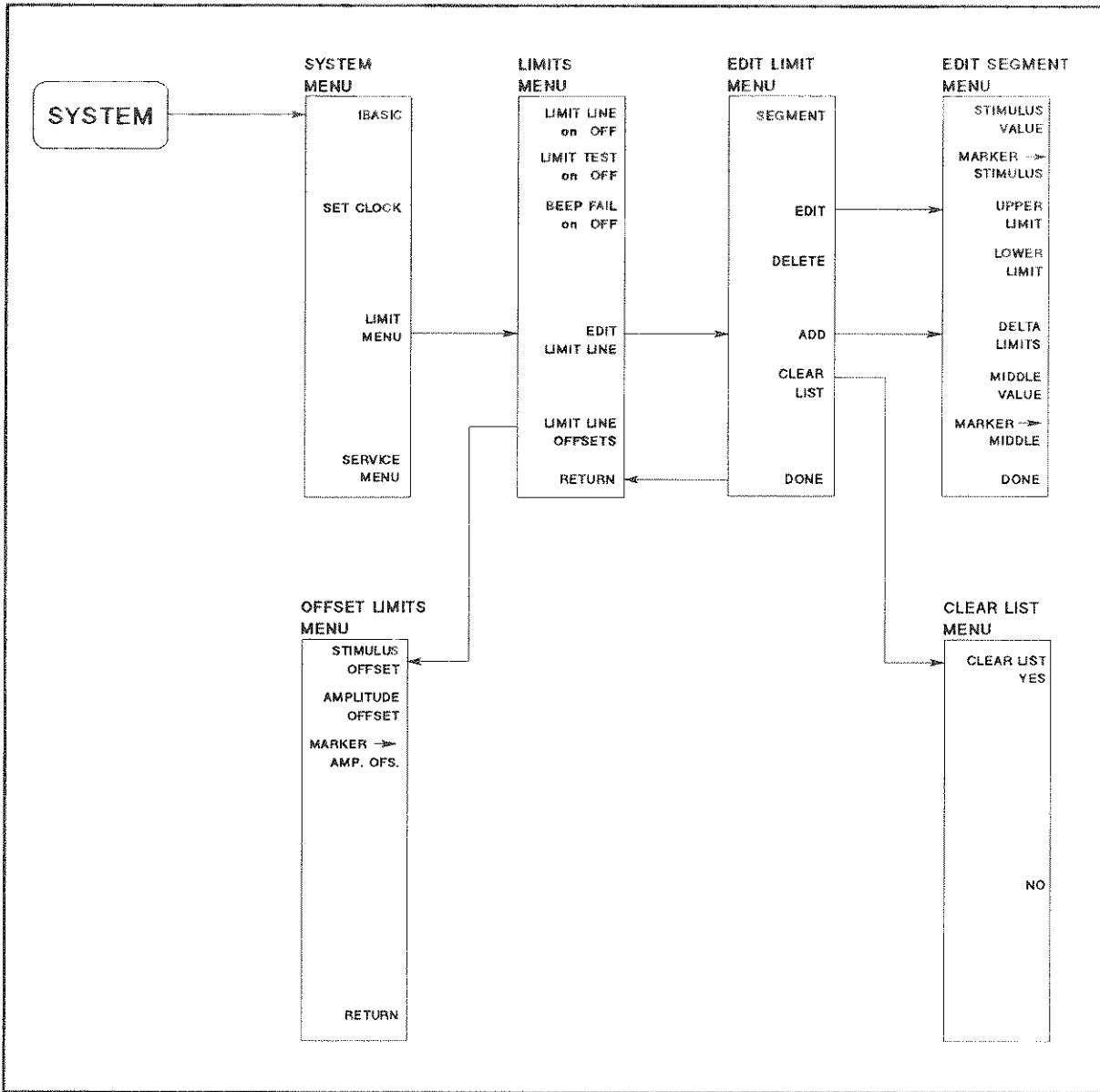

C2009009

Figure 9-10. Softkey Menus Access from the **LIMIT MENU** softkey.

How Limit Lines are Entered

Before limit lines can be explained, the concept of “segments” must be understood. A segment is the node of two limit lines. Refer to Figure 9-11.

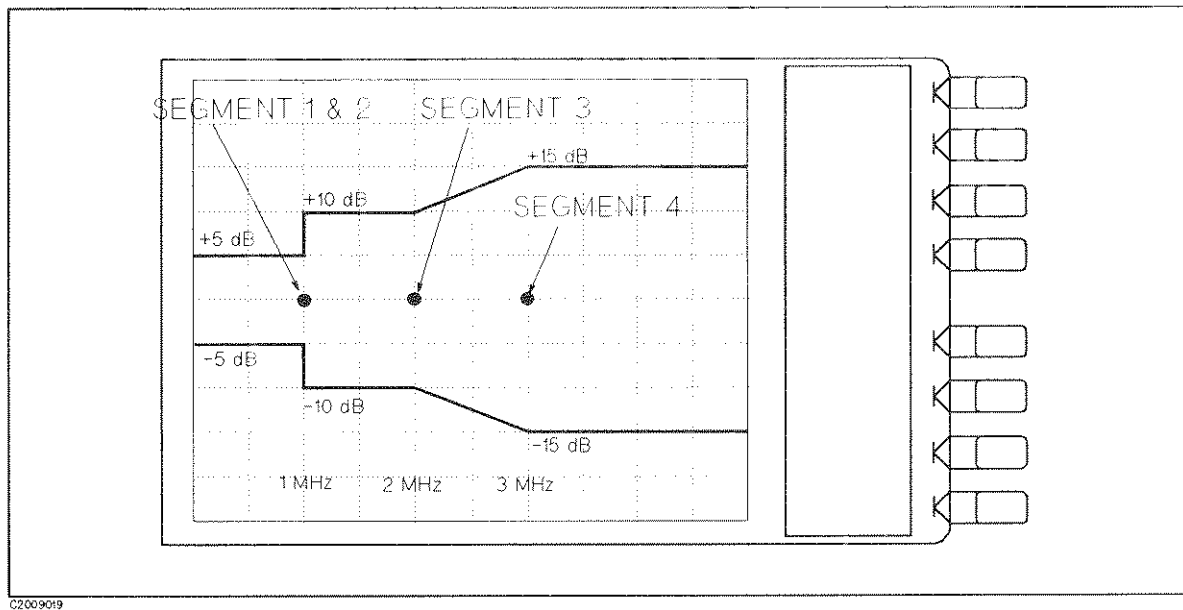

Figure 9-11. The Concept of Segments as a Point between Two Sets of Limit Lines

As you can see in Figure 9-11, segments are distinct points that define where limit lines begin or end. Limit lines span the distance between segments and represent the upper and lower test limits. Figure 9-11 shows another important aspect of limit lines: The most left hand side of set of limit lines will continue from the minimum stimulus value, and the most right hand side of set of limit lines will continue until the maximum stimulus value.

A segment is placed at a specific stimulus value (a single frequency for example). The first segment defines the limit line value hauls from the minimum stimulus value. Once its stimulus value is entered, the upper and lower test limit, +5 dB and -5 dB for example, needs to be supplied.

Defining a second segment defines where the first set of limit lines ends. This process is repeated to create different sets of limit lines, each having new upper and lower limits. Up to 18 segments can be entered.

Limits can be defined independently for the two channels.

The example in Figure 9-11 shows a combination of limit lines which change instantly and gradually.

Segment 1 is at 1 MHz has an upper and lower limit of +5 and -5 dB, respectively. Notice the limit upper and lower lines starts at the minimum frequency and ends at segment 1.

Segment 2 is also at 1 MHz with different upper and lower limits of +10 dB and -10 dB, changing the limit values instantly.

Segment 3 is at 2 MHz with the same limit value as segment 2 to obtain a flat limit lines.

Segment 4 is at 3 MHz with upper and lower limit values of +15 dB and -15 dB, changing the limit values gradually. Notice the limit upper and lower lines starts at the segment continues until the maximum frequency.

Note

Limit lines cannot be cut, so when limit lines are needed partially along the stimulus axis, the non-limit-testing portion must be entered also. Set the non-limit-testing portion by forcing the upper and lower limit values out of range, +500 dB and -500 dB for example.

Both an upper limit and a lower limit (or delta limits) must be defined: if only one limit is required for a particular measurement, force the other limit out of range, +500 dB or -500 dB for example.

Turning Limit Lines Limit Testing On and Off

Limit lines and limit testing features are OFF unless explicitly turned ON by the user. After entering the limit line information, you may turn ON the limit line feature and optionally the limit testing features. Turning these features OFF has no effect on the entered limit line information.

Segments Entering Order Needs Notice

Generally, the segments do not have to be entered in any particular order: the analyzer automatically sorts them and lists them on the display in increasing order of stimulus value.

One exception is when two segments have the same stimulus value as described in Figure 9-11. If the same stimulus values exist, the analyzer draws the limit lines according to entered segment order. For example in Figure 9-11, segment 1 should be entered in advance of segment 2.

Saving the Limit Line Table

Limit line information is lost if **PRESET** is pressed or if the line switch is turned OFF. However, the **SAVE** and **RECALL** keys can save limit line information along with all other current analyzer settings. Limit line table information can be saved on a disk.

Offsetting the Stimulus or Amplitude of the Limit Lines

All limit line entries can be offset in either stimulus or amplitude values. The offset affects all segments simultaneously.

Supported Display Formats

Limit *lines* are displayed only in Cartesian format. In polar and Smith chart formats, limit testing of one value is available: the value tested depends on the marker mode and is the magnitude or the first value in a complex pair. The message "NO LIMIT LINES DISPLAYED" is shown on the display in polar and Smith formats.

Use a Sufficient Number of Points or Errors May Occur

Limits are checked only at the actual measured data points. If you do not select a sufficient number of points, it is possible for a device to be out of specification without a limit test failure indication.

To avoid this, be sure to specify a high enough number of points. In addition, if specific stimulus points must be checked, use the list sweep features described in Chapter 5 so that the actual measured data points are checked, exactly.

Displaying, Printing, or Plotting Limit Test Data

The “list values” feature in the copy menu prints or displays a table of each measured stimulus value. The table includes limit line and/or limit test information (if these functions are turned on). If limit testing is on, an asterisk “*” is listed next to any measured value that is out of limits.

If the limit lines are on, and other listed data allows sufficient space, the following will also be displayed:

- Upper limit and lower limit
- The margin by which the device passes or fails the nearest limit

For more information about the list values feature, refer to “Copy More Menu” in Chapter 10.

Results of Plotting or Printing the Display with Limit Lines ON

If limit lines are on, they are shown when you print or plot the display. If limit testing is on, the PASS or FAIL message is included as well.

Limits Menu

This menu independently toggles the limit lines, limit testing, and limit fail beeper. It also leads to the menus that define and modify the limits.

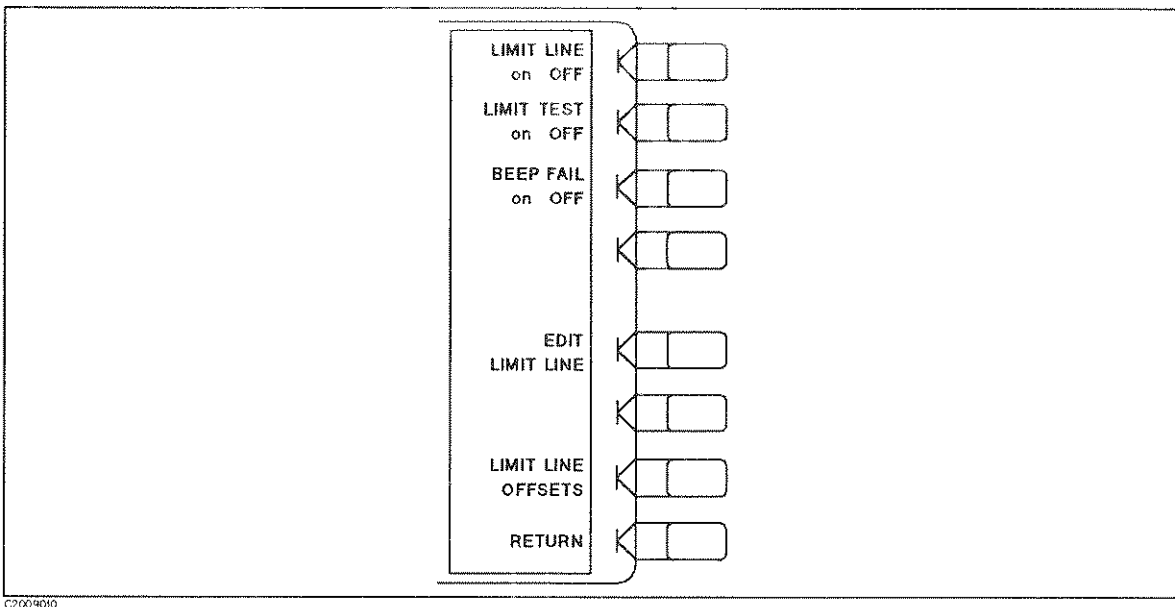

Figure 9-12. Limits Menu

LIMIT LINE on OFF (LIMILINEON, LIMILINEOFF) turns limit lines ON or OFF. To define limits, use the **EDIT LIMIT LINE** softkey described below. If limits have been defined and limit lines are turned on, the limit lines are displayed on the display for visual comparison of the measured data in all Cartesian formats.

If limit lines are on, they can be saved in disk with an instrument state. In a listing of values from the copy more menu with limit lines ON and limit test ON, the upper limit and lower limit are listed together with the pass or fail margin, as long as other listed data allows sufficient space.

LIMIT TEST on OFF (LIMITESTON, LIMITESTOFF) turns limit testing ON or OFF. When limit testing is on, the data is compared with the defined limits at each measured point. Limit tests occur at the end of each sweep, whenever the data is updated and when limit testing is first turned ON.

Limit testing is available for both magnitude and phase values in Cartesian formats. In polar and Smith chart formats, the value tested depends on the marker mode and is the magnitude or the first value in a complex pair. The message "NO LIMIT LINES DISPLAYED" is displayed in polar and Smith chart formats if limit lines are turned ON.

Five different ways of indications of pass or fail status are provided when limit testing is ON.

- A PASS or FAIL message is displayed at the right of the display.
- The limit fail beeper sounds if it is turned ON.
- In a listing of values using the copy menu, an asterisk * is shown next to any measured point that is out of limits.
- A bit is set in the HP-IB status byte.

■ The PASS/FAIL line in the I/O port on the analyzer rear panel goes to TTL LOW level.

BEEP FAIL on OFF (BEEPFAILON, BEEPFAILOFF) turns the limit fail beeper ON or OFF. When limit testing is ON and the fail beeper is on, a beep is emitted each time a limit test is performed and a failure detected. The limit fail beeper is independent of the warning beeper and the operation complete beeper, both of which are described in “Display More Menu” in Chapter 6.

EDIT LIMIT LINE (EDITLIML) displays a table of limit segments on the lower half of the display. The edit limits menu is presented so that limits can be defined or changed.

LIMIT LINE OFFSETS leads to the offset limits menu, which offsets the complete limit set in either stimulus or amplitude value.

RETURN goes back to the system menu.

Edit Limits Menu

This menu is used to add new segments or select existing segments to be edited. The **ADD** and **EDIT** softkeys in this menu provides the edit segment menu (described later), which lets you select stimulus and limit values.

Note



Before editing the limit lines, it is convenient to turn the limit lines on using the **LIMIT LINE on OFF** softkey. This displays the limit lines while you editing.

A table of limit values appears on the display when this menu is provided. A thorough description of how segments work is described at the beginning of this section. Read that information before continuing.

For each segment, the table shows the segment number, stimulus value, upper limit, and lower limit. Limit values can be entered as upper and lower limits or as delta limits with a middle value.

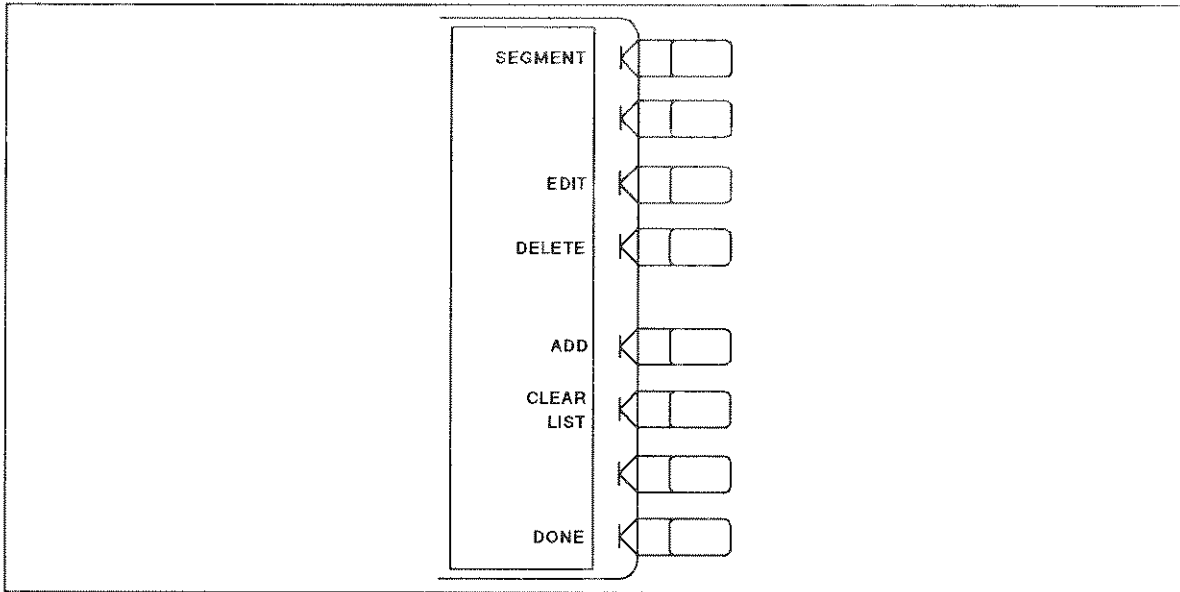

C7009011

Figure 9-13. Edit Limits Menu

SEGMENT specifies which limit segment in the table is to be edited. A maximum of eight sets of segment values are displayed at one time, and the list can be scrolled up or down to show other segment entries. Use the entry block controls to move the pointer “>” next to the required segment number. The indicated segment can then be edited or deleted. If the table of limits is designated “EMPTY”, new segments can be added using the **ADD** or **EDIT** softkey.

EDIT (LIMSEDI) displays the edit segment menu, which defines or modifies the stimulus value and limit values of a specified segment. If the table was empty, a default segment is displayed.

DELETE (LIMSDEL) deletes the segment indicated by the pointer “>”.

ADD (LIMSADD) displays the edit segment menu and adds a new segment to the end of the list. The new segment is initially a duplicate of the segment indicated by the pointer “>” and selected with the **SEGMENT** softkey. If the table was empty, a default segment is displayed.

CLEAR LIST leads to the clear list menu, which clears all of the segments in the limit test.

DONE (LIMEDONE) sorts the limit segments and displays them on the display in increasing order of stimulus values. The limits menu is returned to the screen.

Edit Segment Menu

This menu is used to set the value of the individual limit segments. The segment to be modified, or a default segment, is selected in the edit limits menu.

The stimulus value can be set with the controls in the entry block or with a marker (the marker is turned ON automatically when this menu is presented). The limit values can be defined as upper and lower limits, or delta limits and middle value.

As new values are entered, the tabular listing of limit values is updated.

As described in the beginning of this section, generally segments do not have to be listed in any particular order: the analyzer sorts them automatically in increasing order of start stimulus value when the **DONE** key in the edit limits menu is pressed. However, the easiest way to enter a set of limits is to start with the lowest stimulus value and define the segments from left to right of the display, with limit lines turned ON as a visual check.

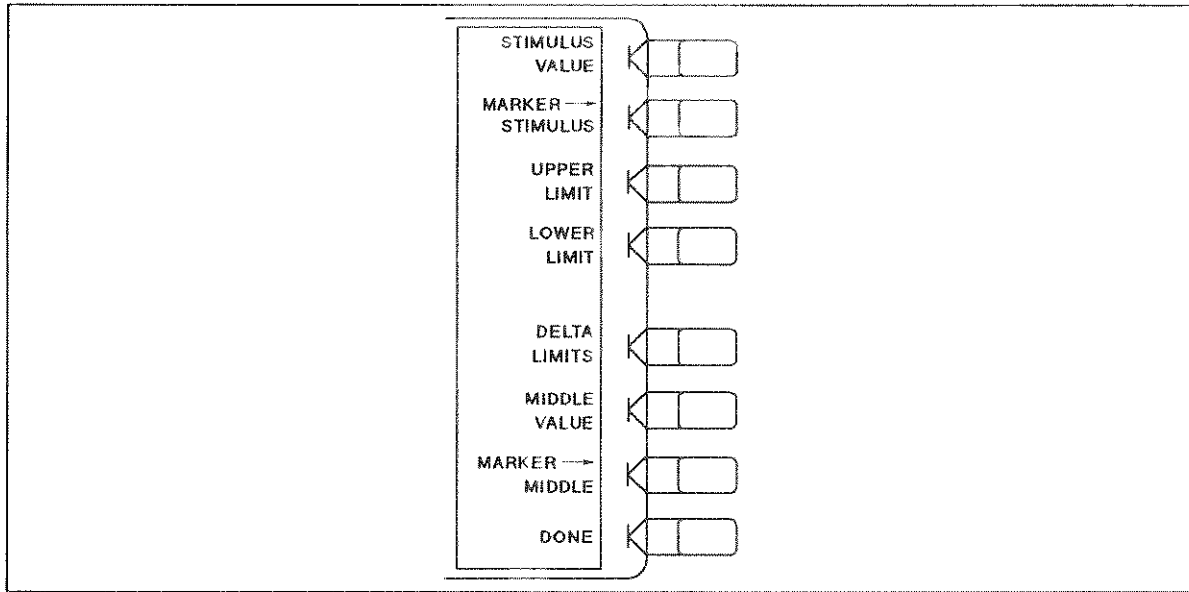

C2009012

Figure 9-14. Edit Segment Menu

STIMULUS VALUE (LIMS) sets the starting stimulus value of a segment, using entry block controls.

MARKER → STIMULUS (MARKSTIM) sets the stimulus value of a segment using the active marker. Move the marker to the desired starting stimulus value before pressing this key, and the marker stimulus value is entered as the segment stimulus value.

UPPER LIMIT (LIMU) sets the upper limit value for the segment. If a lower limit is specified, an upper limit must also be defined. If no upper limit is required for a particular measurement, force the upper limit value out of range (for example +500 dB)

When **UPPER LIMIT** or **LOWER LIMIT** is pressed, all the segments in the table are displayed in terms of upper and lower limits, even if they were defined as delta limits and middle value.

If you attempt to set an upper limit that is lower than the lower limit, or vice versa, both limits will be automatically set to the same value.

LOWER LIMIT (LIML) sets the lower limit value for the segment. If an upper limit is specified, a lower limit must also be defined. If no lower limit is required for a particular measurement, force the lower limit value out of range (for example -500 dB).

DELTA LIMITS (LIMD) sets the limits an equal amount above and below a specified middle value, instead of setting upper and lower limits separately. This is used in conjunction with **MIDDLE VALUE** or **MARKER → MIDDLE**, to set limits for testing a device that is specified at a particular value plus or minus an equal tolerance.

For example, a device may be specified at $-5 \text{ dB} \pm 3 \text{ dB}$. Enter the middle value as -5 dB and the delta limits as 3 dB .

When **DELTA LIMITS** or **MIDDLE VALUE** is pressed, all the segments in the table are displayed in these terms, even if they were defined as upper and lower limits.

MIDDLE VALUE (LIMM) sets the midpoint for **DELTA LIMITS**. It uses the entry controls to set a specified amplitude value vertically centered between the limits.

MARKER → **MIDDLE** (MARKMIDD) sets the midpoint for **DELTA LIMITS** using the active marker to set the middle amplitude value of a limit segment. Move the marker to the desired value or device specification, and press this key to make that value the midpoint of the delta limits. The limits are automatically set an equal amount above and below the marker.

DONE (LIMSDON) terminates a limit segment definition, and returns to the edit limits menu.

Clear List Menu

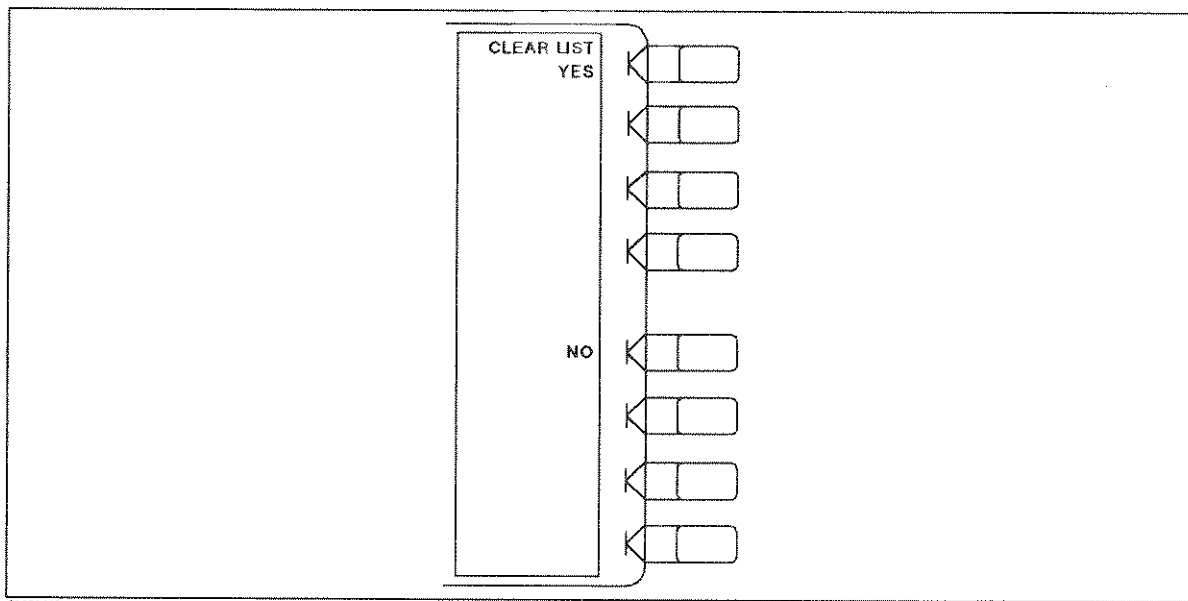

C2009013

Figure 9-15. Clear List Menu

CLEAR LIST YES (LIMCLEL) clears all of the segments in the limit line and returns to the edit limit menu.

NO cancels clearing the segment and returns to the edit limit menu.

Offset Limit Menu

This allows all segments to be offset in either stimulus value or amplitude value. This is useful for changing the limits to correspond with a change in the test setup, or for device specifications that differ in stimulus or amplitude.

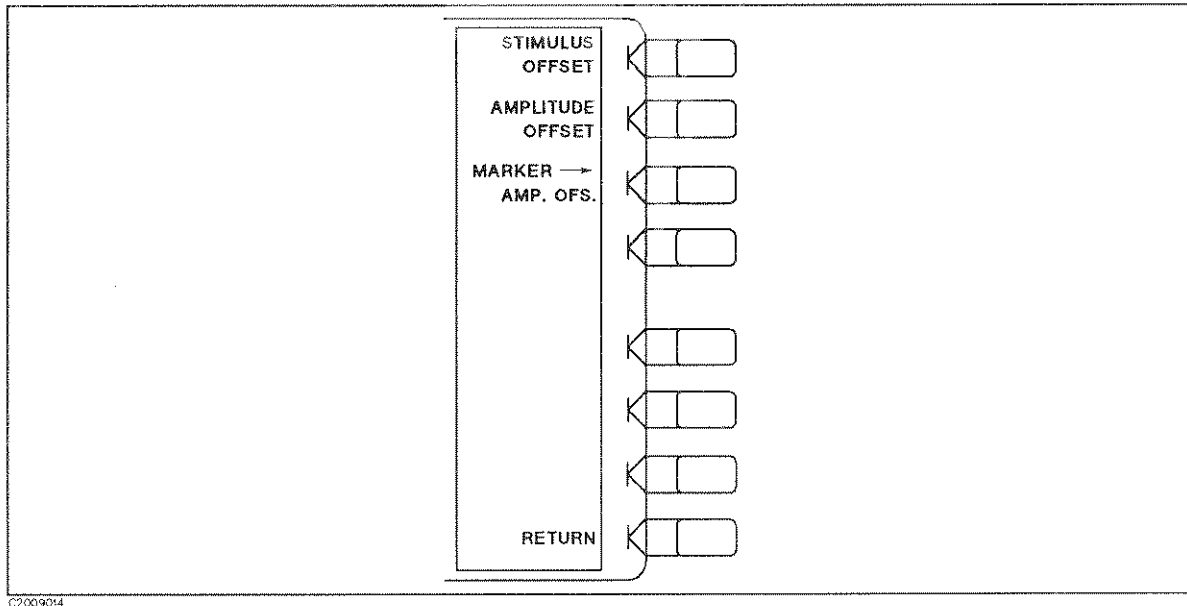

Figure 9-16. Offset Limit Menu

STIMULUS OFFSET (LIMISTIO) adds to or subtracts an offset from the stimulus value. This allows limits already defined to be used for testing in a different stimulus range. Use the entry block controls to specify the offset required.

AMPLITUDE OFFSET (LIMIAMP0) adds or subtracts an offset in amplitude value. This allows previously defined limits to be used at a different power level. For example, if attenuation is added to or removed from a test setup, the limits can be offset an equal amount.

MARKER → AMP. OFS. (LIMIMAOF) uses the active marker to set the amplitude offset. Move the marker to the desired middle value of the limits and press this softkey. The limits are then moved so that they are centered an equal amount above and below the marker at that stimulus value.

RETURN goes back to the limit line menu.

INSTRUMENT BASIC (OPTION 002)

HP Instrument BASIC gives the analyzer programmability without any external controller. HP Instrument BASIC is subset of HP BASIC and allows all of the analyzer's measurement capabilities and any other HP-IB compatible instrument to be programmed. For more information of Instrument BASIC, refer to *Using HP Instrument BASIC with the HP 8751A*, and the *HP Instrument BASIC Manual Set* furnished to Option 002.

Contents

10. Making Hard Copies	
INTRODUCTION	10-1
About Making Hard Copies, Where Compatible Printers and Plotters are Mentioned	10-1
Where to Find Tutorial Information	10-1
Printing/Plotting with or without a Controller on the Bus	10-1
PRINT/PLOT BUFFER	10-1
COPY KEY	10-2
Copy Menu	10-4
Print/Plot Setup Menu	10-5
Select Quadrant Menu	10-7
Define Plot Menu	10-8
Pen Numbers	10-8
Scale Plot Menu	10-9
Copy More Menu	10-11
Copy Cal Kit Menu	10-13
Copy Standard Number Menu	10-14
Copy List Sweep Menu	10-14
Copy Limit Test Menu	10-15
Screen Menu	10-16

Figures

10-1. Softkey Menus Accessed from the COPY Key	10-3
10-2. Copy Menu	10-4
10-3. Print/Plot Setups Menu	10-5
10-4. Select Quadrant Menu	10-7
10-5. Define Plot Menu	10-8
10-6. Scale Plot Menu	10-9
10-7. Full, Upper and Lower Graticule	10-10
10-8. Copy More Menu	10-11
10-9. Copy Cal Kit Menu	10-13
10-10. Copy Standard Number Menu	10-14
10-11. Copy List Sweep Menu	10-14
10-12. Copy Limit Test Menu	10-15
10-13. Screen Menu	10-16

Tables

10-1. Default Plotting Parameters	10-6
10-2. Pen Numbers	10-8
10-3. List Value Format	10-12

Making Hard Copies

INTRODUCTION

About Making Hard Copies, Where Compatible Printers and Plotters are Mentioned

The analyzer can use HP-IB to output measurement results directly to a compatible printer or plotter, without the use of an external controller. The information shown on the display can be copied to a compatible Hewlett-Packard plotter or graphics printer. A plotter provides better resolution than a printer for data displays, while a printer provides higher speed for tabular listings. Refer to the General Information and Specifications section for information about compatible plotters and printers.

Where to Find Tutorial Information

Tutorial information on how to plot or print is supplied in the *User's Guide*.

Printing/Plotting with or without a Controller on the Bus

To generate a plot or printout from the front panel when there is no other controller on the bus, the analyzer must be in the system controller HP-IB mode. If a controller is connected to the analyzer, the analyzer must take control from the controller to initiate a hard copy. To do this, the analyzer must be in the addressable mode by receiving a pass control command from the controller. The controller essentially gives the analyzer permission to control the bus.

Refer to "BUS MODE" in Chapter 12 for HP-IB controller modes and "LOCAL Key" in Chapter 9 for setting addresses.

PRINT/PLOT BUFFER

The analyzer can continue operation while a hard copy is in progress. To abort a hard copy before it is finished, press COPY ABORT. If a hard copy is in progress and a second hard copy is attempted, the message "PRINT/PLOT IN PROGRESS, ABORT WITH COPY ABORT" is displayed and the second attempt is ignored. An aborted hard copy cannot be continued: the process must be initiated again if a copy is still required.

COPY KEY

The HP-IB programming command is shown in parenthesis following the key or softkey.

The **COPY** key provides access to the menus used for controlling external plotters and printers and defining the plot parameters.

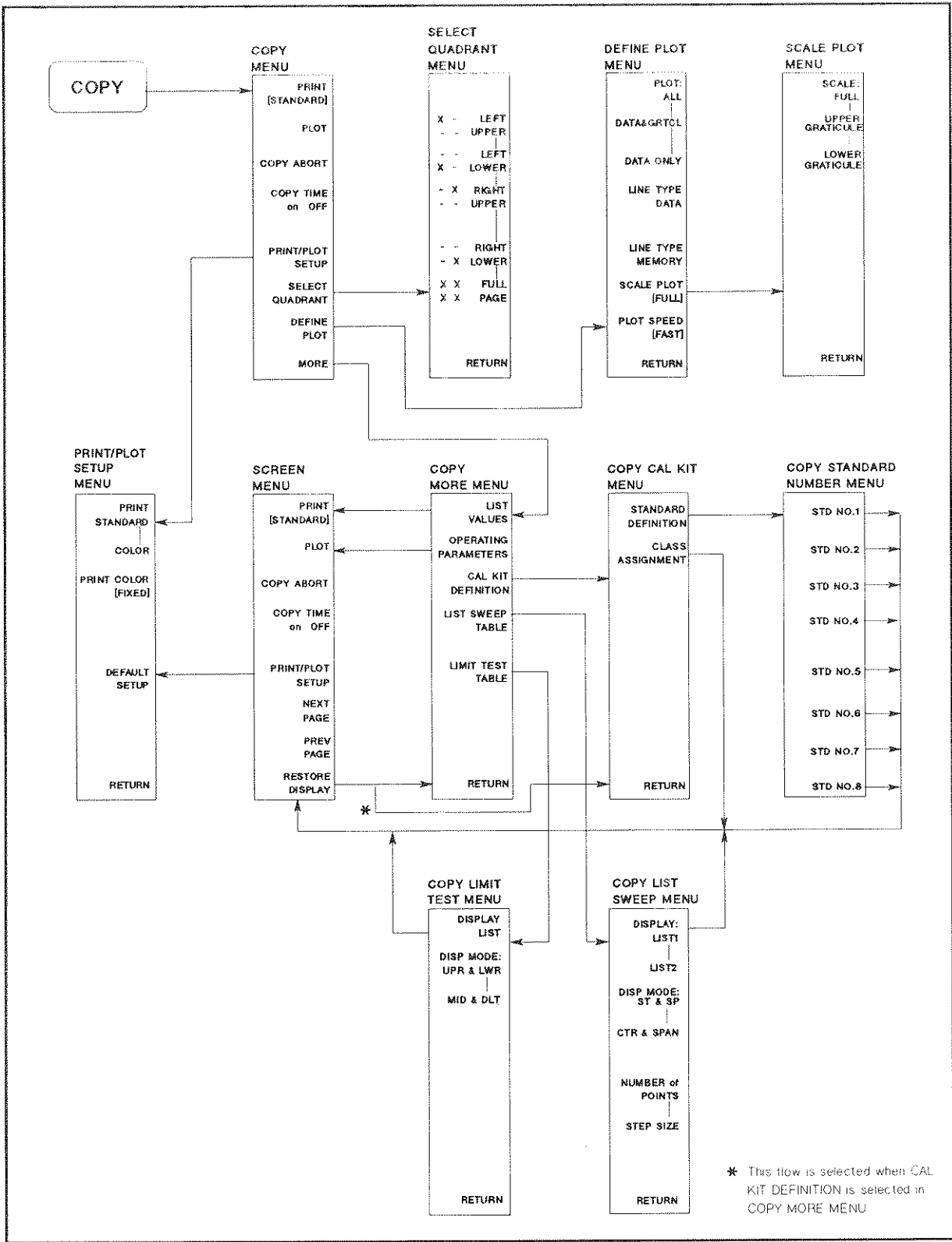

C2010001

Figure 10-1. Softkey Menus Accessed from the **COPY** Key

Copy Menu

This copies the display to a printer or to a plotter using the default plot parameters, without the need to access other menus. For user-defined plot parameters, a series of additional menus is available.

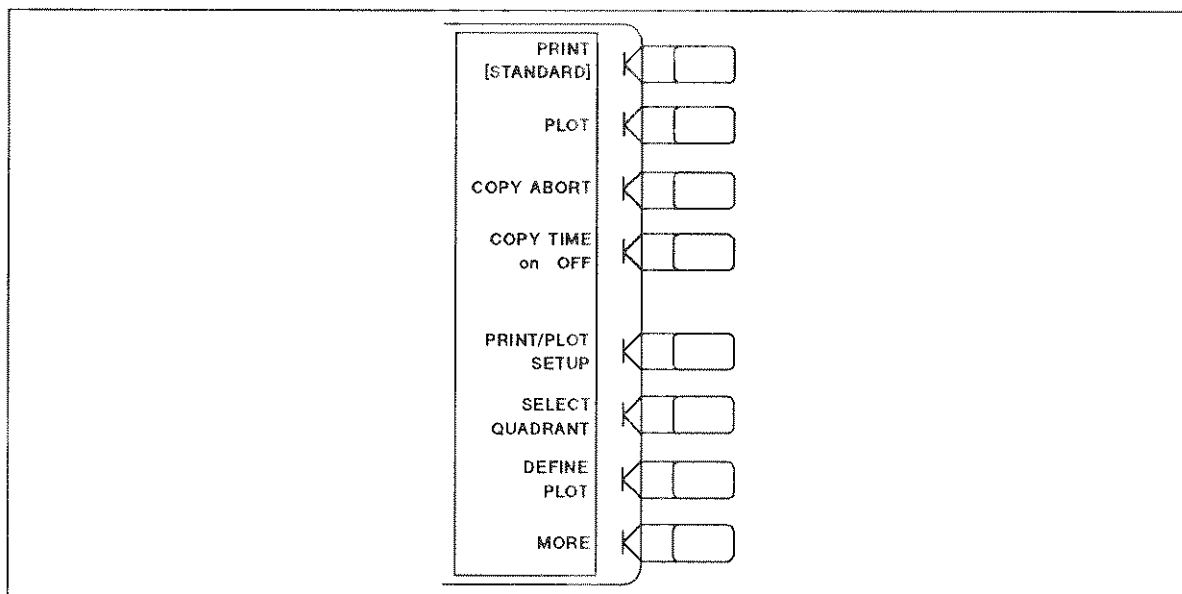

Figure 10-2. Copy Menu

When the print or plot function is engaged, the analyzer takes a “snapshot” of the display and sends it to the printer or plotter through a buffer. Once the data is transferred to the buffer, the analyzer is free to continue measurements while the data is being printed or plotted.

PRINT [STANDARD] (PRINALL) identifies the printer selected in the print/plot setups menu: either **STANDARD** for a black and white printer or **COLOR** for a color printer. The default setting at power on is **STANDARD**. When pressed, this softkey causes an exact copy of the display to be printed.

Note

Before pressing this softkey, you must:



- set the analyzer to the system controller mode.
- make sure the analyzer’s printer HP-IB address and the printer set HP-IB address match.

PLOT (PLOT) plots the display to a compatible HP graphics plotter, using the currently defined plot parameters (or default parameters). Any or all displayed information can be plotted, except the softkey labels and display listings such as the frequency list table, or limit table. (List values, operating parameters, or cal kit definition can be plotted using the screen menu explained later in this chapter. However, this is considerably slower than printing.)

Note



Before pressing this softkey, you must:

- set the analyzer to the system controller mode.
- make sure the analyzer's plotter HP-IB address and the plotter set HP-IB address match.

COPY ABORT (COPA) aborts a plot or print in progress.

COPY TIME ON/OFF (COPTON, COPTOFF) turns the "time stamp" on or off for a print or plot. When you select print, the time and date are printed out first, followed by the information shown on the display. When you select plot, the time and date are plotted on the message area. Refer to "**SYSTEM KEY**" in Chapter 9 for setting the internal clock.

PRINT/PLOT SETUP presents the print/plot setup menu. This menu allows you to copy the display to a printer capable of graphics plotting or tabular listing. For information on compatible printers and plotter with the analyzer, refer to the General Information section.

SELECT QUADRANT leads to the select quadrant menu, which provides the capability of drawing quarter-page plots. This is not used for printing.

DEFINE PLOT leads to the define plot menu, which specifies which elements of the display are to be plotted. This is not used for printing.

MORE leads to the copy more menu, which prints or plots the measurement value list, operation parameter list, calibration kit definition list, list sweep table, or limit test table.

Print/Plot Setup Menu

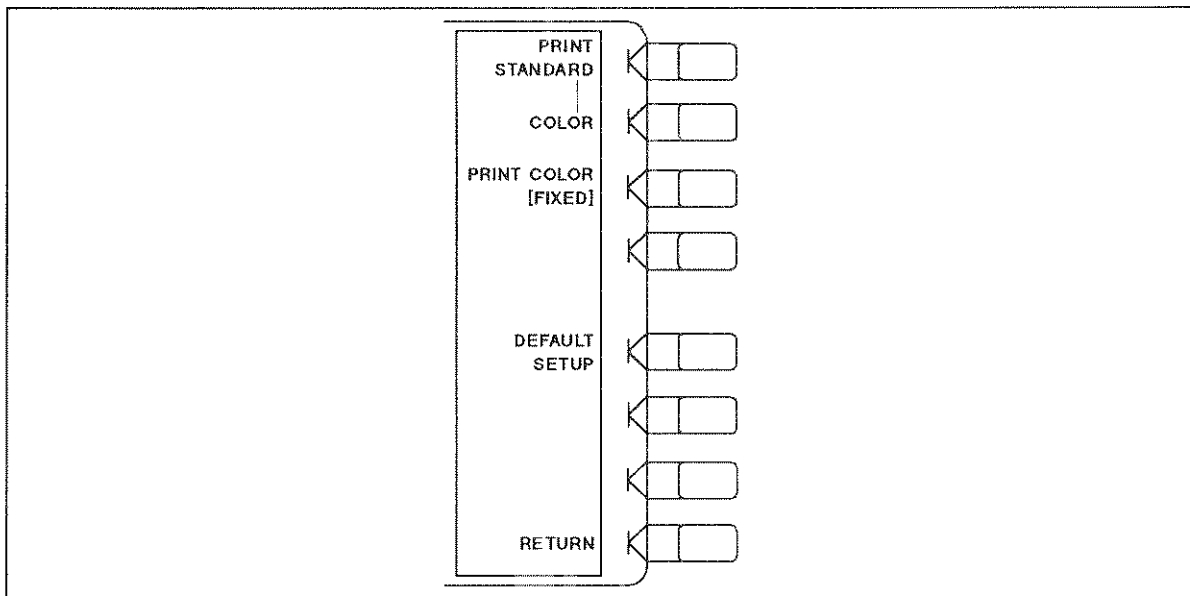

Figure 10-3. Print/Plot Setups Menu

PRINT: STANDARD (PRIS) sets the print command to the default selection, a standard printer that prints in black only or a color printer (PaintJet) to yield a black-only print.

COLOR (PRIC) sets the print command to default to color. The PRINT [COLOR] command does NOT work with a black and white printer.

PRINT COLOR [FIXED] (PRICFIXE, PRICVARI) toggles the printing color between [FIXED] and [VARIABLE]. If "FIXED" is selected, the analyzer prints a hard copy with default colors. If "VARIABLE" is selected, the analyzer prints a hard copy with colors as similar as possible to the display colors, which can be adjusted by the user. Refer to "DISPLAY KEY" in Chapter 6 for display colors adjustment.

Note



Because of the limited number of the printer ink colors, the printed color will not be the same as the displayed.

DEFAULT SETUP (DFLT) resets the plotting parameters to their default values. These defaults are as follows:

Table 10-1. Default Plotting Parameters

- Select quadrant: Full page
- Define plot: All plot elements on
- Plot scale: Full
- Plot speed: Fast
- Line type: 7 (solid line) for both trace and memory

Default setups do not apply to printing.

RETURN returns to the copy menu.

Select Quadrant Menu

This selects a full-page plot, or a quarter-page plot in any quadrant of the page.

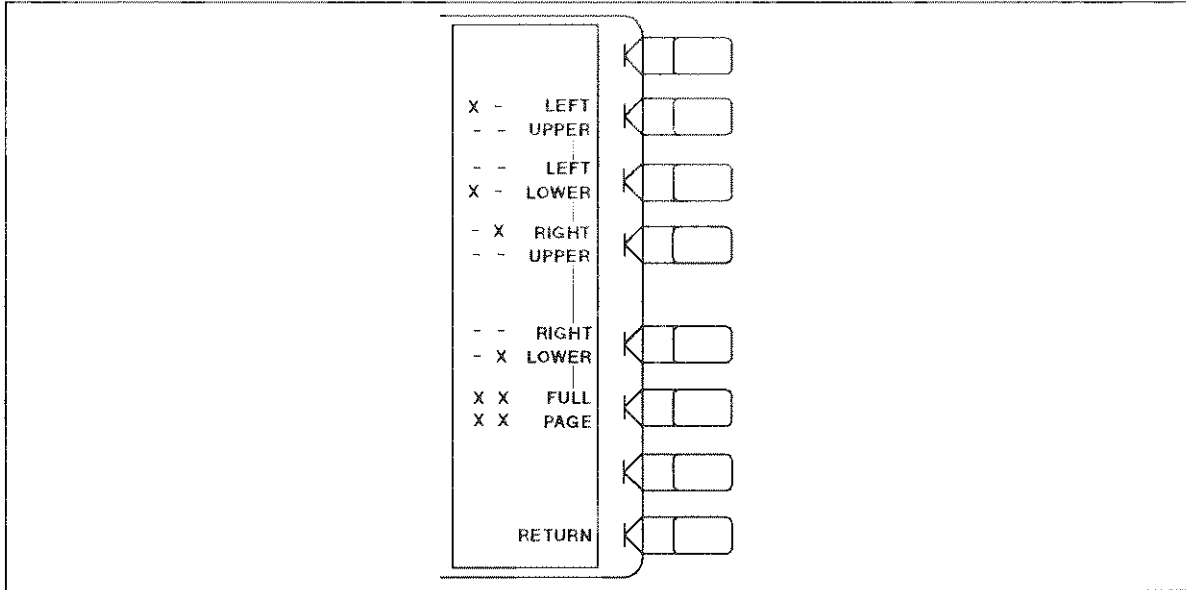

Figure 10-4. Select Quadrant Menu

LEFT UPPER (LEFU) draws a quarter-page plot in the upper left quadrant of the page.

LEFT LOWER (LEFL) draws a quarter-page plot in the lower left quadrant of the page.

RIGHT UPPER (RIGU) draws a quarter-page plot in the upper right quadrant of the page.

RIGHT LOWER (RIGL) draws a quarter-page plot in the lower right quadrant of the page.

FULL PAGE (FULP) draws a full-size plot according to the scale defined with **SCALE PLOT** in the define plot menu (described next).

RETURN returns to the copy menu.

Define Plot Menu

This menu allows selective plotting of portions of the measurement display. Different plot elements can be turned on or off as required. In addition, different selections are available for plot speed and plot scale, to allow plotting on transparencies and preprinted forms.

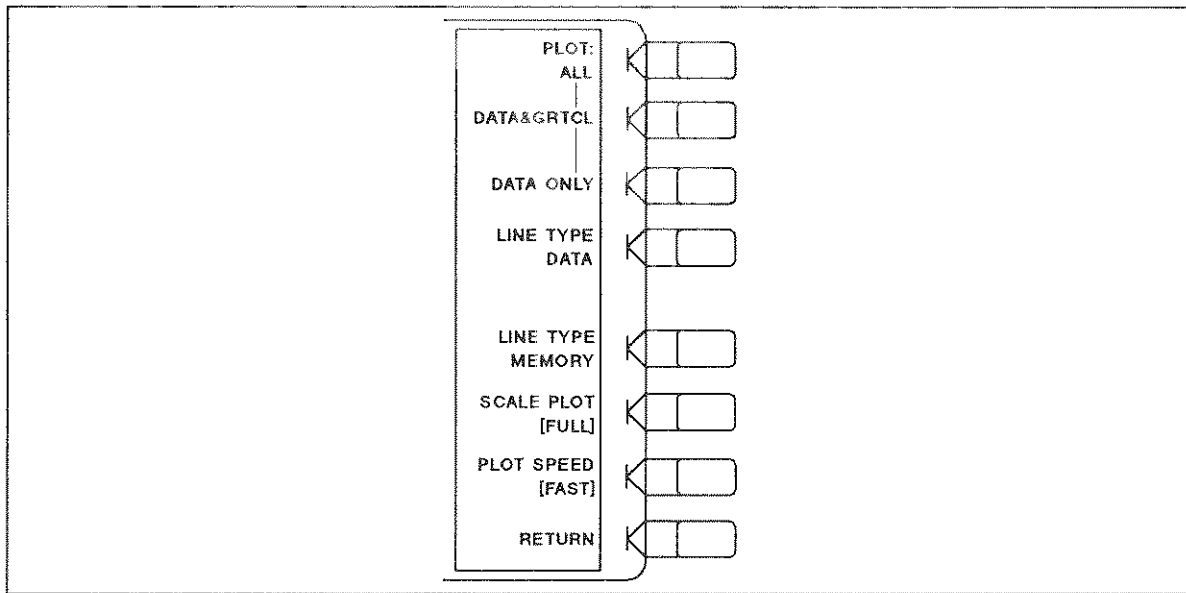

Figure 10-5. Define Plot Menu

Pen Numbers

Pen numbers for each display elements are fixed as follows:

Table 10-2. Pen Numbers

Display Element	Channel 1	Channel 2
Data	1	2
Memory	5	6
Graticule	3	3
Text	1 / 4 / 5	2 / 4 / 6
Marker	1 / 5	2 / 6

PLOT: ALL (PLOALL) selects to plot all the information displayed on the display except for the softkey.

DATA & GRATCL (PLODGRAT) selects to plot the measured data and memory data, and also the graticules.

DATA ONLY (PLODONLY) selects to plot only the measured data and memory data.

LINE TYPE DATA (LINTDATA) selects the line type of the trace data for plot. The default line is a solid unbroken line.

LINE TYPE MEMORY (LINTMEMO) selects the line type of the memory trace for plot. The default line type is a solid unbroken line.

10-8 Making Hard Copies

SCALE PLOT leads to the scale plot menu, which selects a plot scale.

PLOT SPEED (PLOSFAST, PLOSSLOW) provides two plot speeds, **FAST** and **SLOW**. Fast is the proper plot speed for normal plotting. Slow plot speed is used for plotting directly on transparencies: the slower speed provides a more consistent line width.

RETURN returns to the copy menu.

Scale Plot Menu

This menu selects a plot scale, **FULL**, **UPPER GRATICULE**, and **LOWER GRATICULE**.

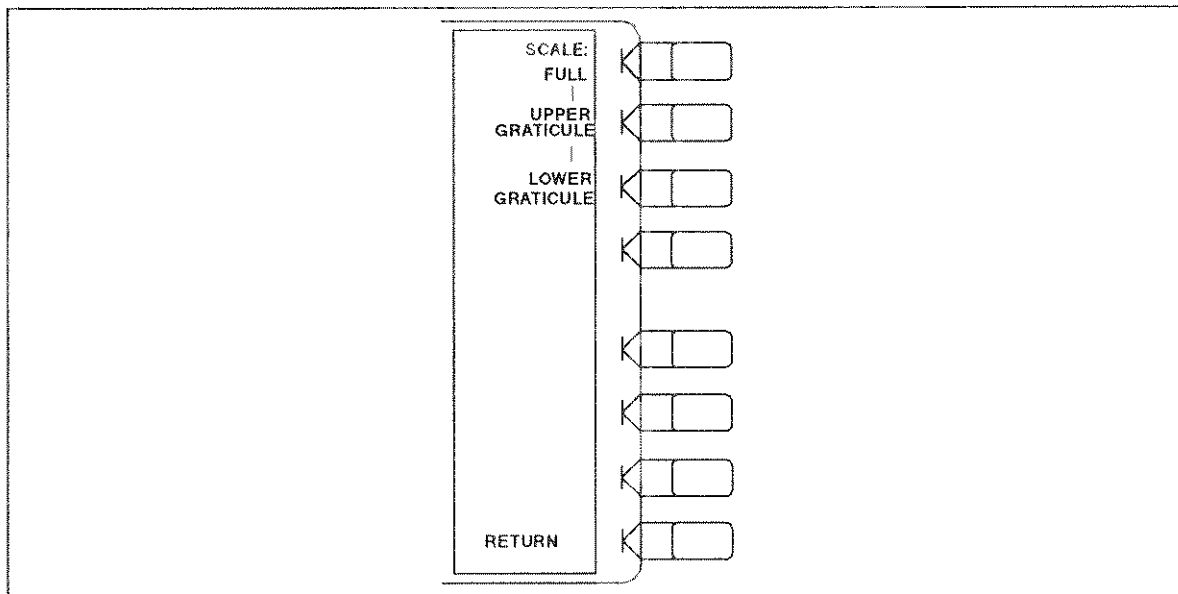

Figure 10-6. Scale Plot Menu

SCALE: FULL (SCAPFULL) selects the normal full size scale for plotting on blank paper, and includes space for all display annotations such as marker values, stimulus values, etc. The entire display fits within the user-defined boundaries of P1 and P2 on the plotter, while maintaining the exact same aspect ratio as the display.

UPPER GRATICULE, **LOWER GRATICULE** (SCAPGU, SCAPGL) expands or reduces the horizontal and vertical scale so that the graticule lower left and upper right corners exactly correspond to the user-defined P1 and P2 scaling points on the plotter. In the dual display mode, the applicable graticule is channel 1 for **UPPER GRATICULE**, or channel 2 for **LOWER GRATICULE**. This is convenient for plotting on preprinted rectangular or polar forms (for example, on a Smith chart).

To plot on a rectangular preprinted graticule, set P1 of the plotter at the lower left corner of the preprinted graticule, and set P2 at the upper right corner.

To plot on a polar and Smith chart formats as an accurate circle, set P1 and P2 so that a rectangular defined by P1 and P2 become a square because the outer circumference is identical to an inscribed circle in the rectangle.

When the display is split (for example, `SPLIT DISP ON`, `MKR LIST ON`), `UPPER` set the upper graticule to the plot area defined `P1` and `P2` and `LOWER` set the lower graticule to the plot area. When the display is not split, `UPPER` and `LOWER` are the same. (Refer to Figure 10-7.)

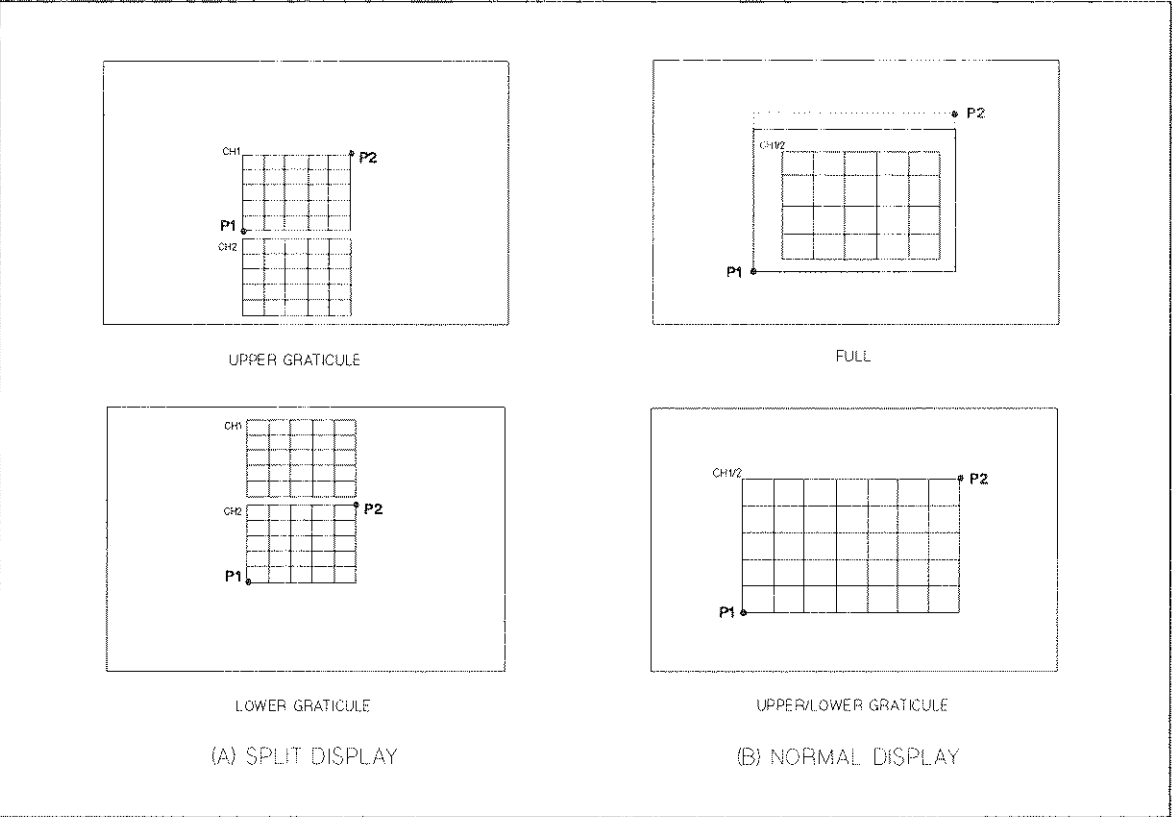

Figure 10-7. Full, Upper and Lower Graticule

Copy More Menu

This menu provides tables of operating parameters, measured data values, and cal kit definitions, which can be copied from the screen to a printer or plotter.

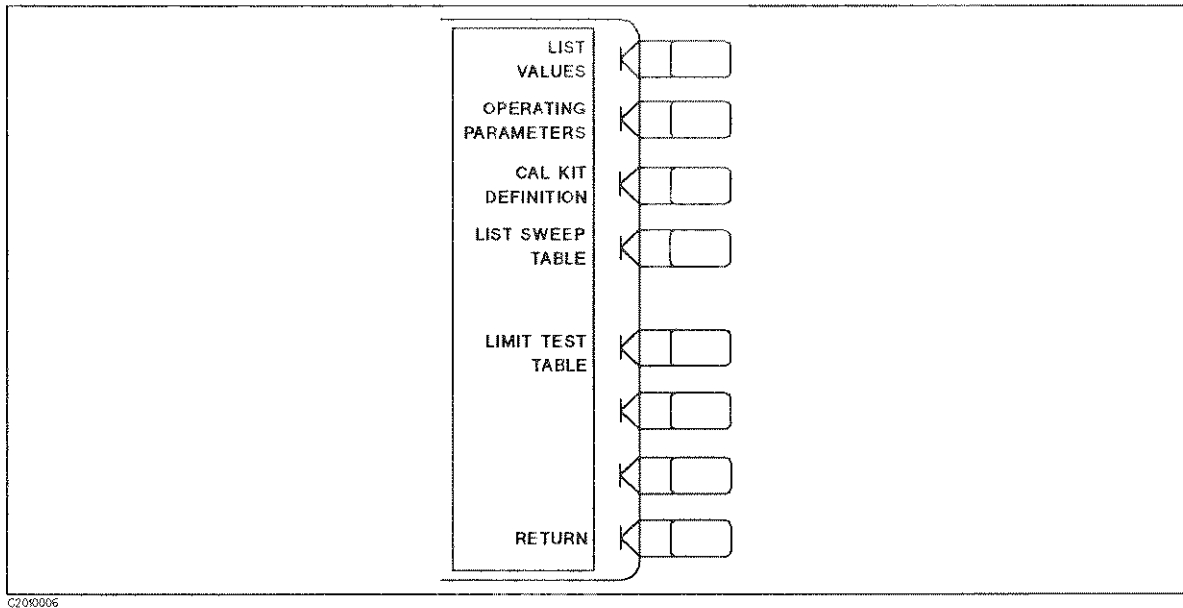

Figure 10-8. Copy More Menu

LIST VALUES (LISV) provides a tabular listing of all the measured data points and their current values, together with limit information if the limit test is ON. At the same time, the screen menu is presented, to enable hard copy listings and access new pages of the table. Twenty one lines of data are listed on each page, and the number of pages is determined by the number of measurement points specified in the stimulus menu.

Table 10-3 shows data listed on the screen when **DUAL CHAN** is OFF. The margin listed is smaller difference value between measurement value and either upper limit or lower limit. When plus margin means the test is pass, and minus means fail.

Table 10-3. List Value Format

Display Format	Column Number				
	1	2	3	4	5
LOG MAG PHASE DELAY LIN MAG SWR REAL IMAGINARY EXPANDED PHASE	Stimulus	Measurement Data ¹	Margin ²	Upper Limit Value ²	Lower Limit Value ²
SMITH CHART POLAR INV SMITH CHART LOG MAG & PHASE LOG MAG & DELAY	Stimulus	Measurement Data ¹	Measurement Data	Upper Limit Value ²	Lower Limit Value ²

1 * is displayed at the left hand of measurement value when the it fails in the limit testing.

2 This is listed when the limit test is on.

When **DUAL CHAN** is **ON**, stimulus value is listed in the 1st column, measurement data of active channel are listed in the 2nd and 3rd columns, and non-active channel are listed in the 4th and 5th columns. The value listed for each channel are the same as data listed in the 2nd and 3rd columns in Table 10-3.

If **DUAL CHAN** is **ON** and **COUPLED CH IS OFF**, only active channel measurement data is listed.

OPERATING PARAMETERS (OPEP) provides a tabular listing on the display of the key parameters for both channels. The screen menu is presented to allow hard copy listings and access new pages of the table. Four pages of information are supplied. These pages list operating parameters, marker parameters, lists, and system parameters that relate to control of peripheral devices rather than selection of measurement parameters. The listed parameters are as follows:

- Number of points
- Sweep time
- Source power
- Port-1 and 2 attenuator
- Input R, A, and B attenuator
- IF bandwidth
- Averaging factor
- Averaging switch
- Smoothing aperture
- Smoothing switch
- Group delay aperture
- Calibration kit
- Z_0
- Calibration type
- Stimulus conditions when the calibration was performed
- Phase offset

- Port 1 and 2 extension
- Input R, A, and B extension
- Velocity factor
- Conjugate matching circuit and its parameters

CAL KIT DEFINITION provides the copy cal kit menu which prints/plots the calibration kit definitions.

LIST SWEEP TABLE provides a tabular listing on the display of the list sweep table.

LIMIT TEST TABLE provides a tabular listing on the display of the limit value for limit testing.

RETURN returns to the copy menu.

Copy Cal Kit Menu

This provides a tabular listing of the calibration kit definitions. The lists can be hard copied using the copy function. The elements are all the standard and class assignments.

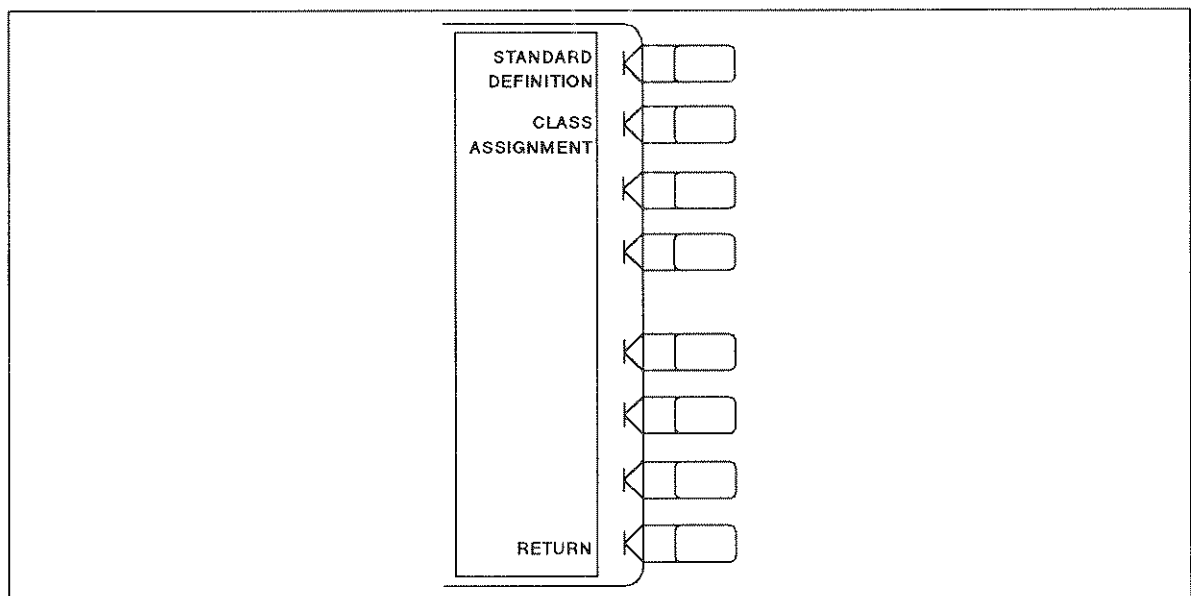

Figure 10-9. Copy Cal Kit Menu

STANDARD DEFINITION provides the copy standard number menu which selects which standard setting be hard copied.

CLASS ASSIGNMENT (CALCASSI) shows the tabular listing of the calibration kit class assignment, and provides the screen menu to prepare for hard copy.

RETURN returns to the copy more menu.

Copy Standard Number Menu

This selects which standard is to be hard copied.

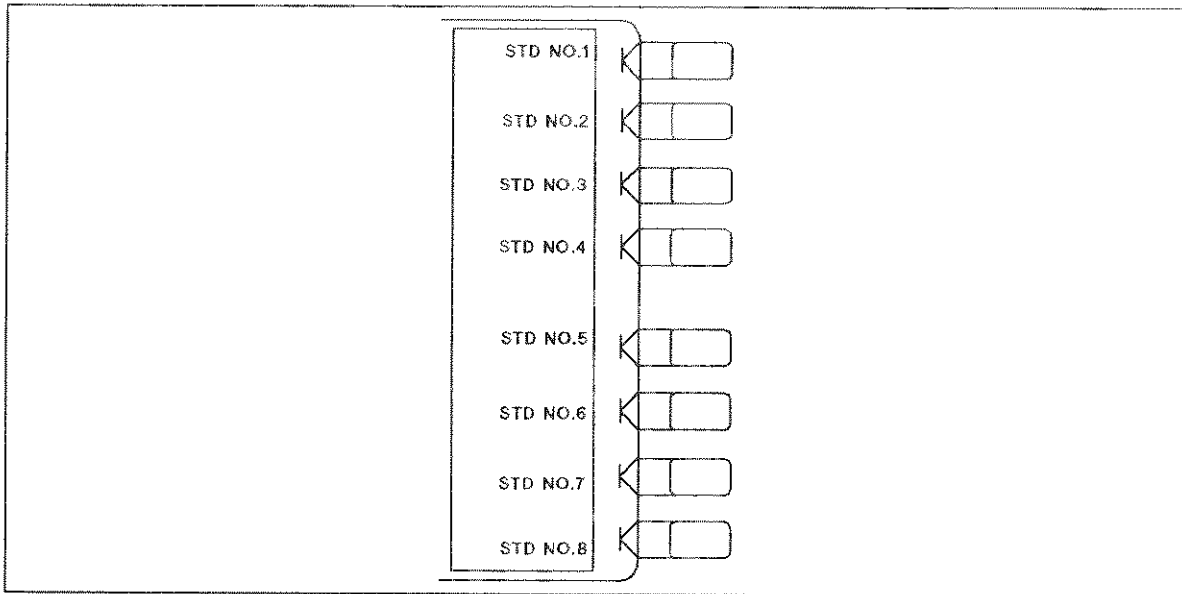

Figure 10-10. Copy Standard Number Menu

STD NO. n (CALC) provides the tabular listing of the standard definitions of the standard number n , and provides the screen menu to prepare for hard copy.

Copy List Sweep Menu

This selects one applicable list sweep table, and defines in what format the list sweep table is to be displayed and hard copied.

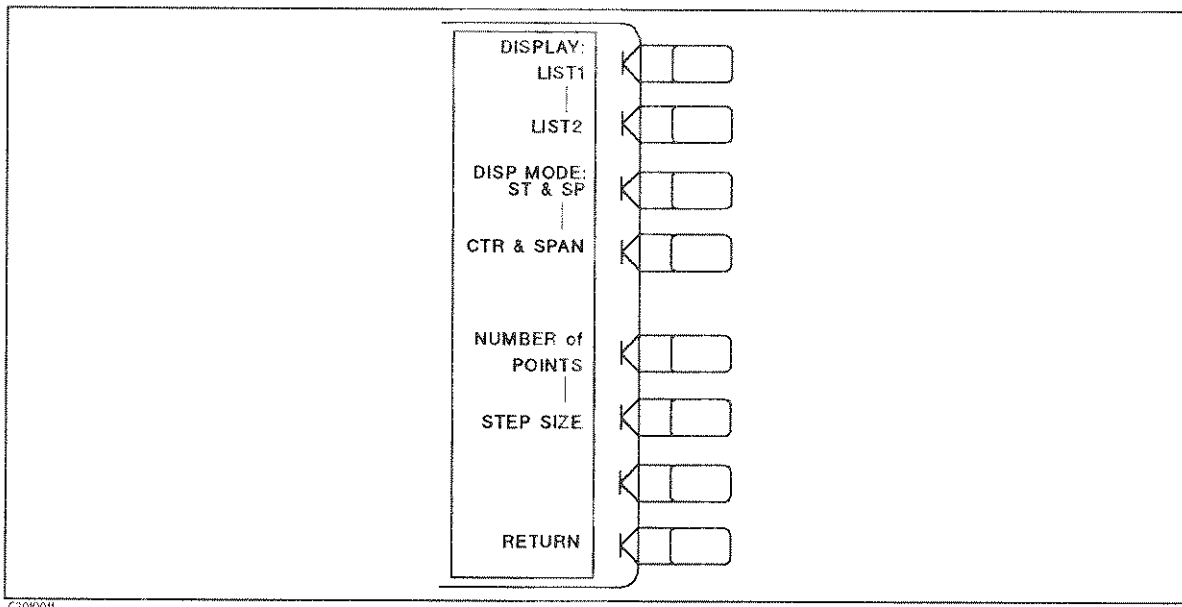

Figure 10-11. Copy List Sweep Menu

DISPLAY: LIST1 (DISL1) selects list sweep Table 1 to be displayed and hard copied.

10-14 Making Hard Copies

LIST2 (DISL2) selects list sweep Table 2 to be displayed and hard copied.

DISP MODE: ST & SP (DISMSTSP) displays the list sweep stimulus range in terms of start and stop.

CTR & SPAN (DISMCTSP) displays the list sweep stimulus range in terms of center and span.

NUMBER of POINTS (DISMNUM) displays the list sweep stimulus resolution in terms of number of points.

STEP SIZE (DISMSTEP) displays the list sweep stimulus resolution in terms of step size.

Copy Limit Test Menu

This defines in what format the limit testing table is to be displayed and hard copied.

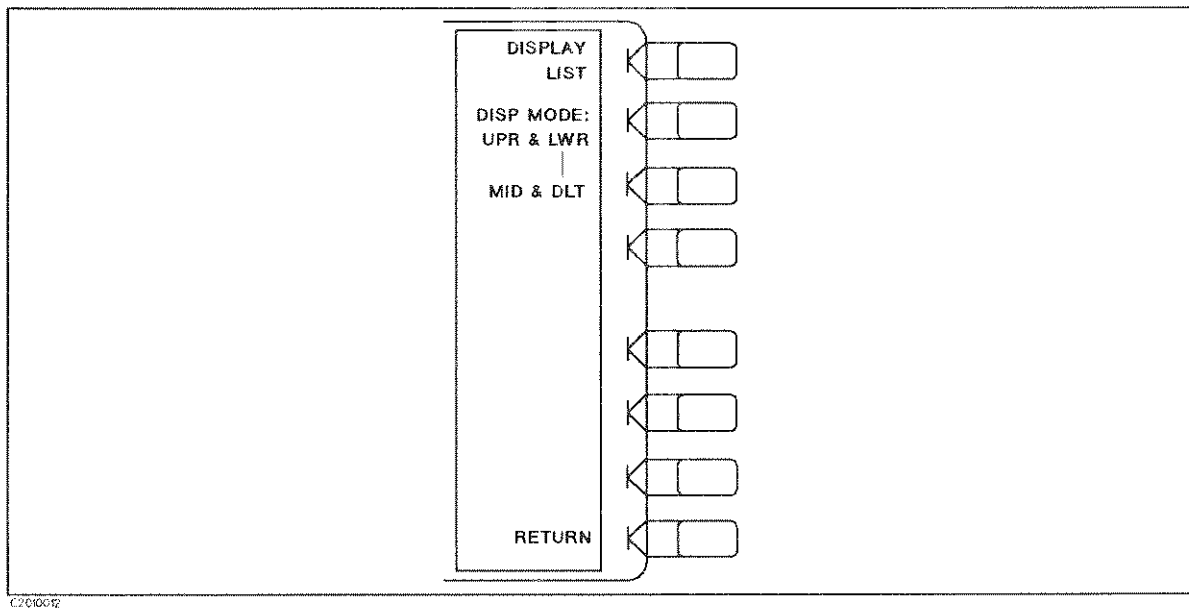

Figure 10-12. Copy Limit Test Menu

DISPLAY LIST (DISLLIST) displays the limit testing table on the display, and provides the screen menu to prepare for hard copy.

DISP MODE: UPR & LWR (DISMUL) selects the upper and lower format, which displays the limit values by upper limit and lower limit.

MID & DLT (DISMMD) selects the middle and delta format, which displays the limit values by middle value and maximum deviation (limit value) from the middle value.

Screen Menu

This menu is used in conjunction with the LIST VALUES, OPERATING PARAMETERS, CAL KIT DEFINITION, LIST SWEEP TABLE, and LIMIT TEST TABLE features, to make hard copy listings of the tables displayed on the screen. To make copies from the front panel, make sure that the analyzer is the system controller (see Chapter 9).

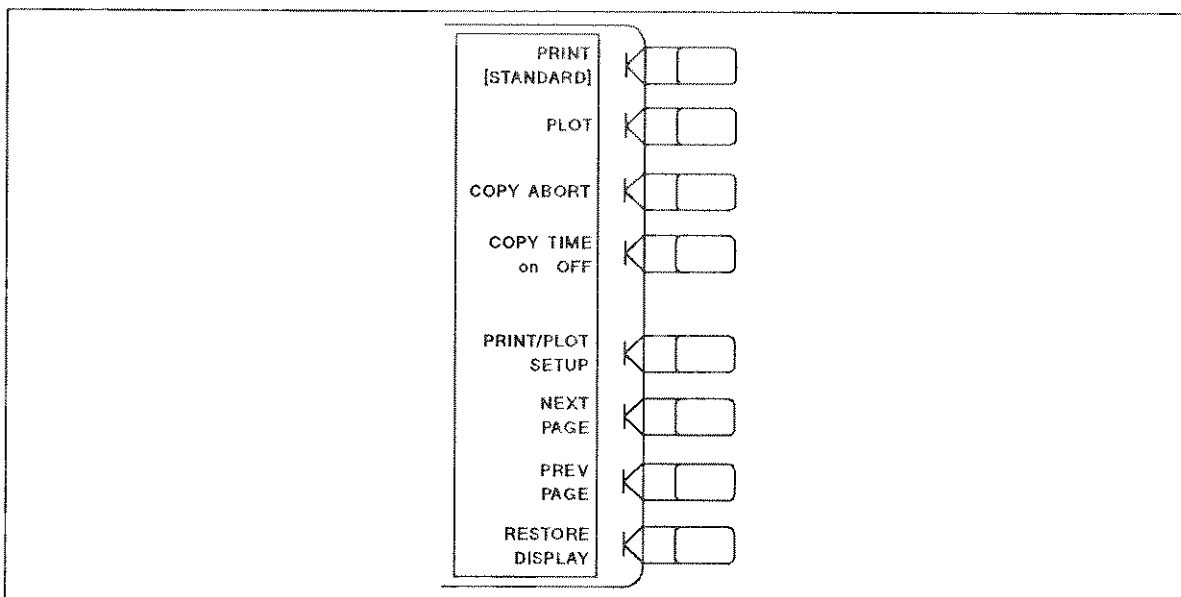

Figure 10-13. Screen Menu

PRINT [STANDARD] (PRINALL) copies one page of the tabular listings to a compatible HP graphics printer. Either **STANDARD**, for a black and white printer, or **COLOR**, for a color printer, is shown in brackets (“[]”). This identifies which printer was selected as the default in the print/plot setups menu. The default setting at power on is standard. Default text for a color printer is black.

PLOT (PLOT) plots one page of the tabular listing on the display with current setup (defined in **SELECT QUADRANT** and **DEFINE PLOT**). The plot size and speed can be change in **DEFINE PLOT MENU** if you want.

Note

Before pressing **PRINT** and **PLOT**, you must:



- set the analyzer to the system controller mode.
- make sure the analyzer's printer HP-IB address and the printer set HP-IB address match.

COPY ABORT (COPA) aborts a plot or print in progress.

COPY TIME on OFF (COPTON, COPTOFF) turns on or off to print or plot out the time and date. When you select print, the time and date are printed first, then the information displayed on display. When you select plot, time and date are plotted just below the title area. Refer to “**SYSTEM KEY**” in Chapter 9 for setting the internal clock.

PRINT/PLOT SETUPS presents the print/plot setups menu. This menu provides menu to set a graphics printer and plotter.

NEXT PAGE (NEXP) displays the next page of information in a tabular listing onto the display.

PREV PAGE (PREP) displays the previous page of information in a tabular listing onto the display.

RESTORE DISPLAY (RESA) turns off the tabular listing and returns the measurement display to the screen.

Contents

11. Saving and Recalling Instrument States and Data	
INTRODUCTION	11-1
THREE DATA GROUPS	11-1
Instrument State	11-1
Internal Data Arrays	11-1
Instrument States and Internal Data Arrays	11-2
ADDITIONAL INFORMATION	11-2
File Names	11-2
Disk Requirements	11-3
Disk Format	11-3
Auto Recall Function	11-3
File Size	11-3
File Structure of Internal Data Arrays File	11-4
File Header	11-4
Data Group	11-4
Data Segment	11-6
SAVE AND RECALL KEYS	11-6
Save Menu	11-8
Save File Menu	11-9
Title Menu	11-10
Define Save Data Menu	11-11
Re-save File Menu	11-12
Disk Menu	11-13
Purge File Menu	11-14
Purge Menu	11-15
Initialize Menu	11-16
Recall Menu	11-17
Recall File Menu	11-18

Figures

11-1. File Header Structure	11-4
11-2. RAW Data Group Structure	11-5
11-3. CAL Data Group Structure	11-5
11-4. Data Segment	11-6
11-5. Softkey Menus Accessed from the SAVE and RECALL Keys	11-7
11-6. Save Menu	11-8
11-7. Save File Menu	11-9
11-8. Title Menu	11-10
11-9. Define Save Data Menu	11-11
11-10. Re-save File Menu	11-12
11-11. Disk Menu	11-13
11-12. Purge File Menu	11-14
11-13. Purge Menu	11-15
11-14. Initialize Menu	11-16
11-15. Recall Menu	11-17
11-16. Recall File Menu	11-18

Tables

11-1. File Size Versus Number of Points	11-3
---	------

Saving and Recalling Instrument States and Data

INTRODUCTION

This chapter describes how to save and recall instrument states and data for later retrieval using the built-in disk drive.

Brief tutorial information on saving and recalling instrument states is provided in the *User's Guide*.

This chapter explains following:

- What information is saved
- **SAVE**, **RECALL** key menu description

Note



The **SAVE** and **RECALL** keys do not access Instrument BASIC programs. Instrument BASIC has its own menus (under **SYSTEM** key) for accessing the built-in disk drive. Refer to “INSTRUMENT BASIC (OPTION 002)” in Chapter 9 for detail.

THREE DATA GROUPS

The analyzer saves one of the following three data groups to the disk.

- Instrument state
- Internal data arrays
- Instrument states and internal data arrays

Instrument State

The instrument state group consists of all front panel settings and the calibration coefficient arrays. This data group can retrieve identical measurement conditions for later use.

Internal Data Arrays

The internal data arrays which is essentially stored in the analyzer's memory consists of the following seven data arrays. Refer to “DATA PROCESSING” in Chapter 1 for complete information on each data array and their relationship.

- *Raw data arrays* hold raw, uncalibrated measurement data.
- *Calibration Coefficients arrays* hold the expanded calibration coefficients obtained by calibration.

Note

The calibration coefficient arrays described in “Instrument State” and in this section differ. The later is processed data, for example interpolated, while the earlier is raw data.

- *Data arrays* hold the calibrated data using the calibration coefficients.
- *Memory arrays* hold the memorized data arrays using the DATA→MEM operation.
- *Unformat arrays* hold the last processed complex number pairs.
- *Trace arrays* hold the formatted data. This is identical with the “format arrays” described in “DATA PROCESSING” in Chapter 1.
- *Memory trace arrays* hold the formatted data of the “memory arrays”.

These arrays can be saved selectively to suit the application. For example, when measuring a number of devices with the same measurement settings, you may need to save only the *trace arrays* for each device.

Saving only the necessary arrays reduces disk space required and the disk access time.

In addition, saving internal data also allows the analysis of the measurement results using an external controller. Refer to “File Structure of Internal Data Arrays File” for more information.

Instrument States and Internal Data Arrays

These consist of the instrument states which includes raw calibration coefficients, the data arrays, and memory arrays. However, saving and retrieving the complete states and data, occupies a lot of disk space.

ADDITIONAL INFORMATION

File Names

All data saved on the built in disk has an identifying name. A file name consists of the lower and upper case alphabet, numbers, and a symbol character. Up to 8 characters can be used for a file name.

Depending on the data group of a file, one of the following extensions is automatically added to the file name.

- “_A” is added to the specified file name if the file contains instrument states, data array, memory array, using the **SAVE ALL** softkey.
- “_S” is added to the specified file name if the file contains instrument states and calibration coefficients, using the **SAVE STATES ONLY** softkey.
- “_D” is added to the specified file name if the file contains the internal data arrays, using the **SAVE DATA ONLY** softkey.

Disk Requirements

The analyzer disk drive accepts a 3.5 inch microfloppy disk. The medium capacity should be 270 k, 720 k, or 1.44 Mbyte. Refer to "System Accessories Available" section in *General Information* for disk part numbers.

Disk Format

The analyzer's built in disk drive can access LIF (logical interchange format) format disks. The disk drive can also initialize a new LIF format disk.

Auto Recall Function

When the analyzer is turned on, it seeks a file named, "AUTOREC". If the file is found, the analyzer automatically recalls the file to retrieve data (usually states).

File Size

The maximum number of files that can be saved on a disk depends on the disk capacity and the total size of the files to be saved. The file size depends on the analyzer settings, such as number of points, calibration type, etc.

Table 11-1 shows the approximate file sizes (in bytes) versus the number of points when the default setting is stored.

Table 11-1. File Size Versus Number of Points

Number of Points	State only	Data only							All
		Raw Data	Cal	Data	Memory	Unformat	Trace	Memory Trace	
201	2 k	26 k	77.5 k	6.5 k	6.5 k	6.5 k	6.5 K	6.5 k	6 k
401	2 k	51.5 k	154 k	13 k	13 k	13 k	13 k	13 k	9 k
801	2 k	102.5 k	308 k	26 k	26 k	26 k	26 k	26 k	16 k

File Structure of Internal Data Arrays File

An internal data arrays file consists of a file header at the top of the file and the data groups following the file header.

Refer to the *HP-IB Programming Manual* for an example BASIC program to access the data.

File Header

Every internal data arrays file begins with a file header. Figure 11-1 shows the header structure.

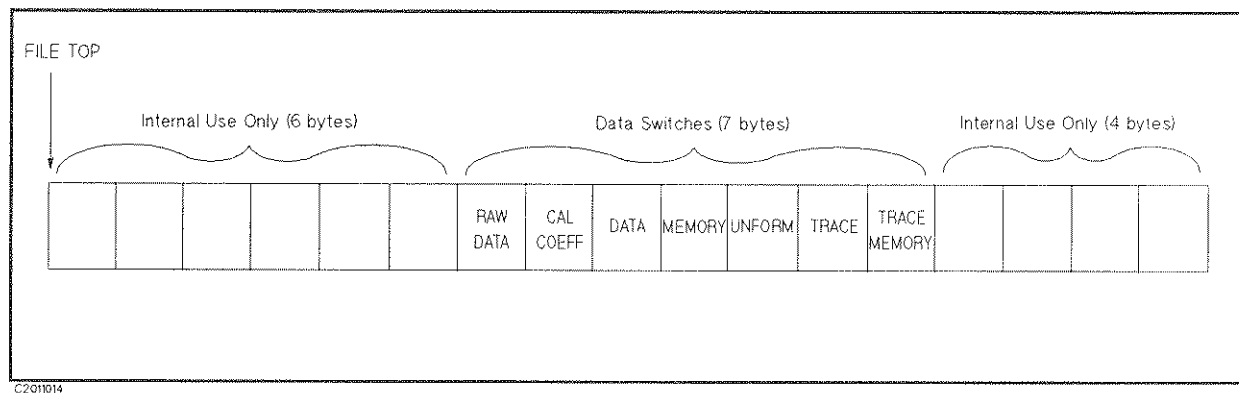

Figure 11-1. File Header Structure

Seven data switches define which data groups follow the file head. Each one-byte switch is either 1 or 0 (decimal value) if the applicable data group exists or not, respectively. The data group to be followed is in the same order of these switches. For example, when the data switches, RAW and TRACE are 1 (on), while the others are off, only the RAW and TRACE (in this order) groups will follow the header.

Data Group

Every data group consists of the same structured data segments. The number of data segments depends on the data group type as follows:

- *RAW DATA* consists of eight data segments as shown in Figure 11-2. They will follow the file header in this order.

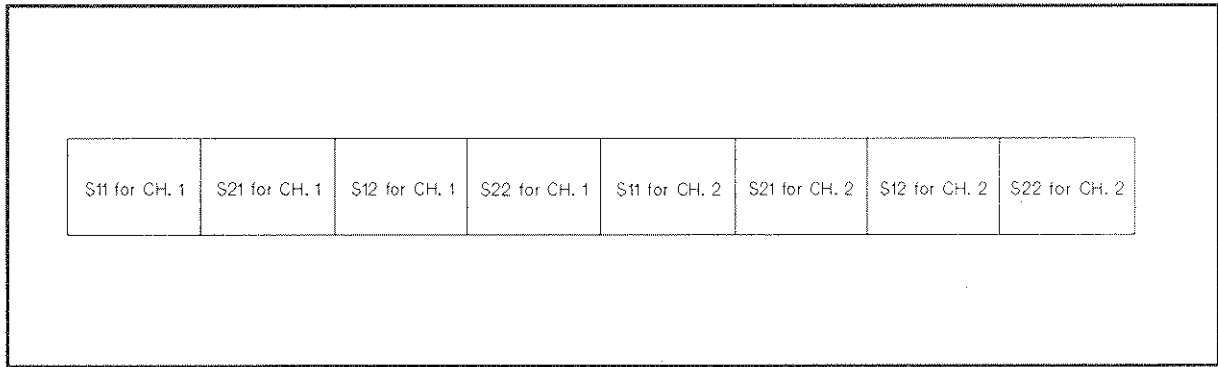

C201106

Figure 11-2. RAW Data Group Structure

- *CAL* consists of 24 data segments as shown in Figure 11-3. The first half of the segments are for channel 1, and the second half of the segments are for channel 2. The contents of each segment depends on the type of calibration performed. (Refer to Chapter 7.)

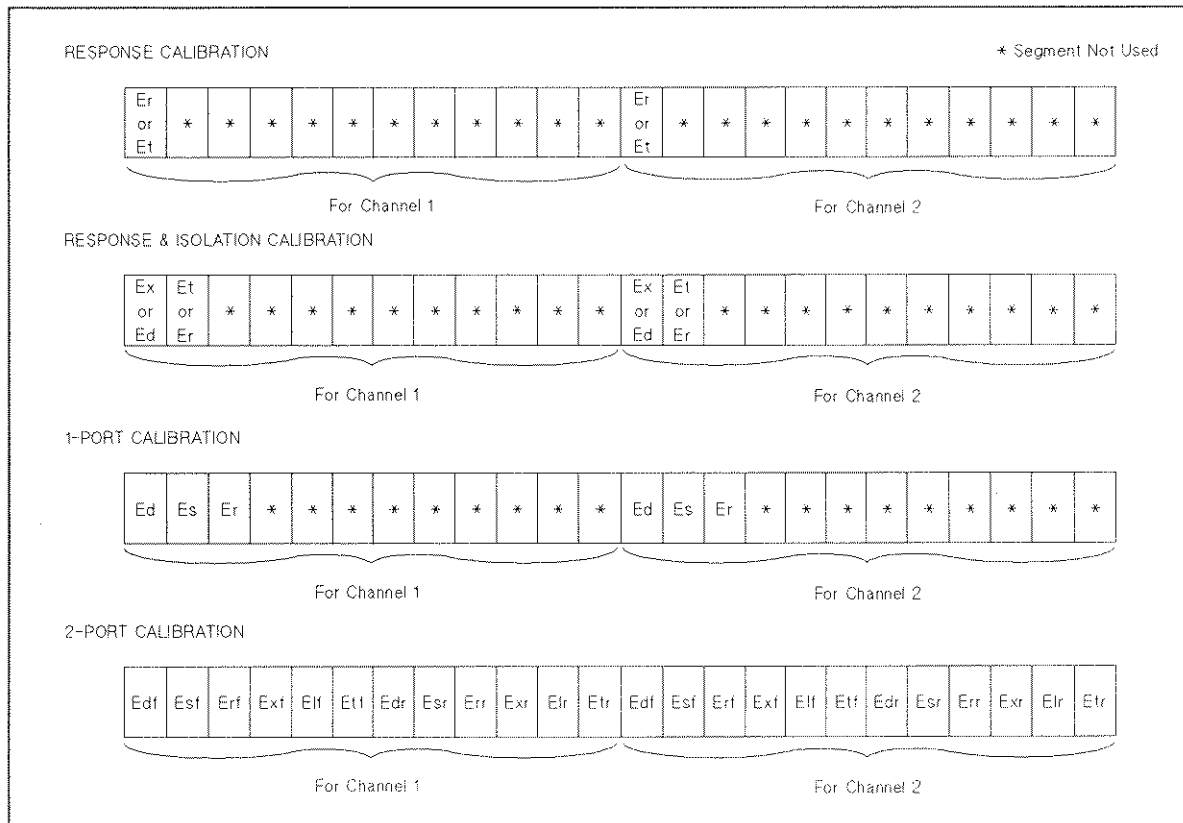

C201106

Figure 11-3. CAL Data Group Structure

- *DATA* consists of two data segments.
- *MEMORY* consists of two data segments.
- *UNIFORM* consists of two data segments.

- *TRACE* consists of two data segments.
- *TRACE MEMORY* consists of two data segments.

Data Segment

The data segment structure is as shown in Figure 11-4.

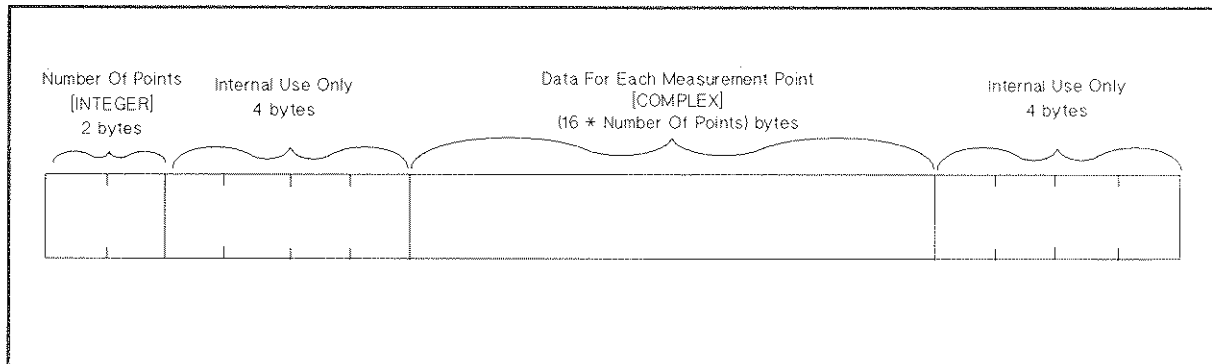

C201017

Figure 11-4. Data Segment

- *Number Of Points (NOP)* is a two-byte INTEGER value. This number is equal to the number of complex data which follows.
- *DATA* is a set of the values for each measurement point. A values are two IEEE 754 double precision floating number (1st value as real part, 2nd value as imaginary part). The data size in bytes can be determined by $16 \times \text{NOP}$.

SAVE AND RECALL KEYS

The HP-IB programming command is shown in parenthesis following the key or softkey.

The **SAVE** key provides access to all the menus used for saving instrument states and data on the disk. This includes the menus used to define titles for disk files, to define the content of disk files, to initialize disks for storage, and to purge files from a disk.

The **RECALL** key leads to the menus that recall the contents of disk files back into the analyzer.

Caution



NEVER remove a disk from the disk drive, when the drive is accessing the disk. During accessing the disk, the yellow LED on the drive lights.

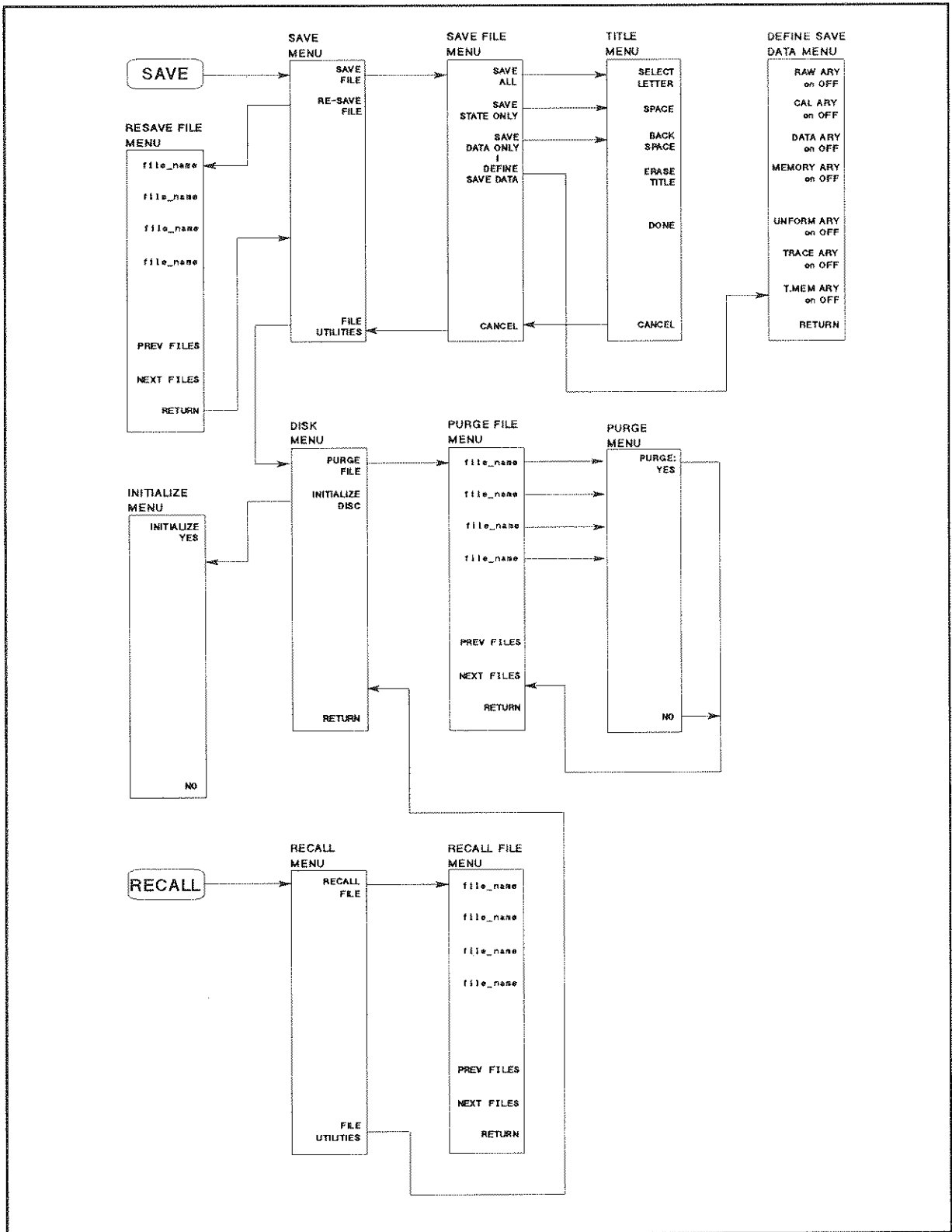

C2011012

Figure 11-5. Softkey Menus Accessed from the **SAVE** and **RECALL** Keys

Save Menu

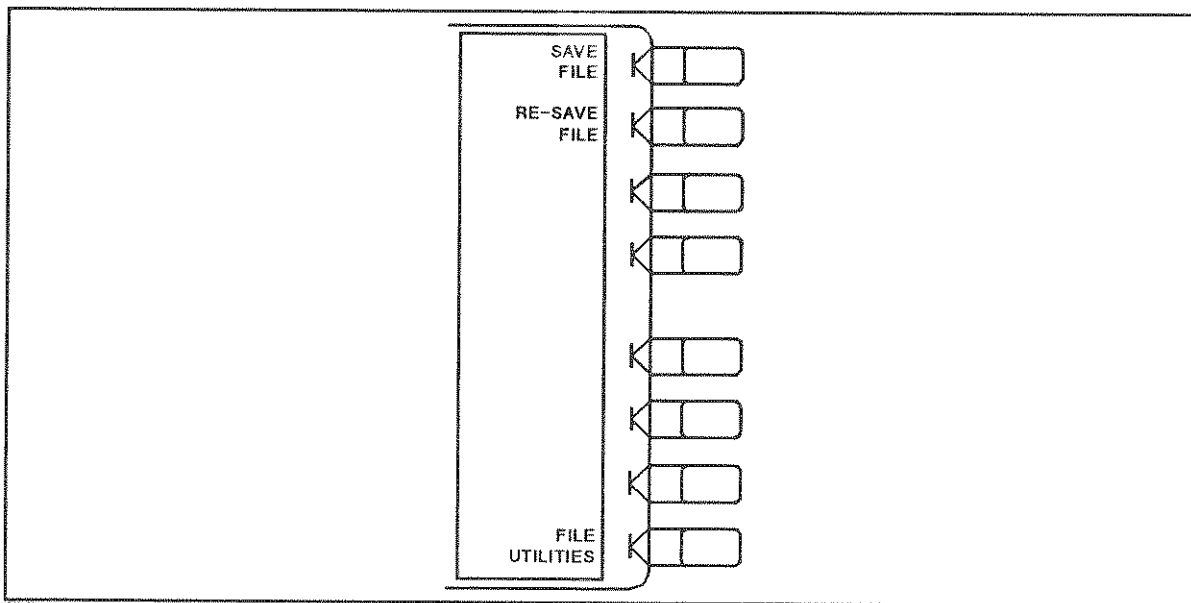

Figure 11-6. Save Menu

SAVE FILE provides the save file menu, which defines the data group to be saved.

RE-SAVE FILE (RESAVD) leads to the re-save file menu, which updates a file already saved.

FILE UTILITIES provides the disk menu, which initializes a new disk, and purges a file from a disk.

Save File Menu

Either or both of internal data arrays and the instrument state can be saved on disk.

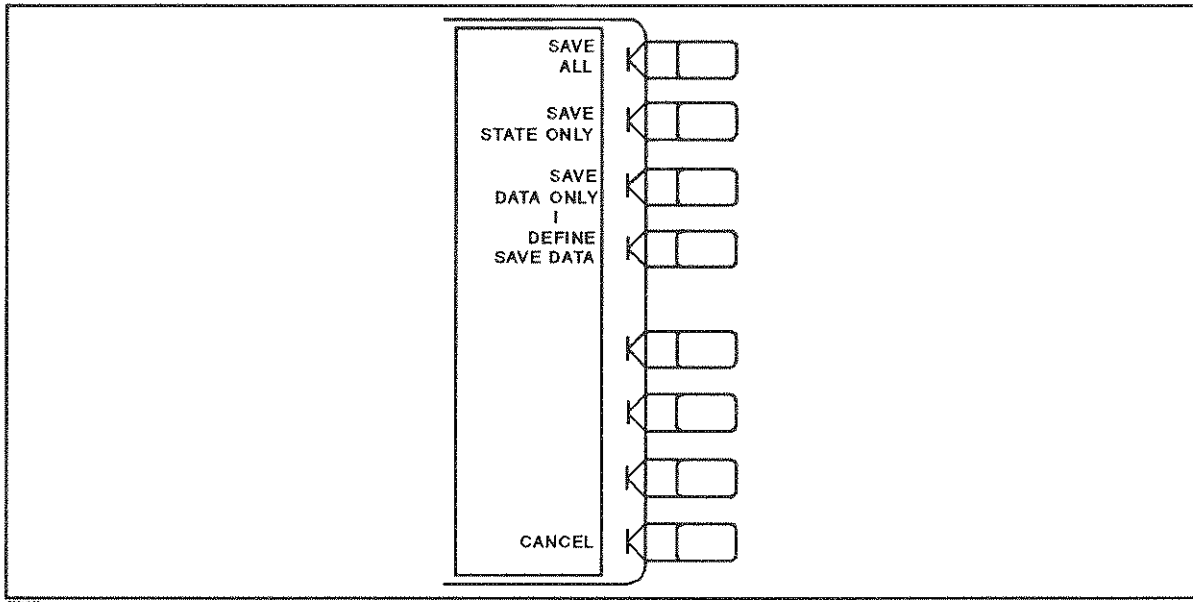

Figure 11-7. Save File Menu

SAVE ALL (SAVDAL) specifies to save the instrument states, the “data arrays”, and the “memory arrays”.

SAVE STATE ONLY (SAVDSTA) specifies to save only the instrument states and the calibration coefficients.

SAVE DATA ONLY (SAVDDAT) specifies to save the internal data arrays which is defined by the **DEFINE SAVE DATA** key.

DEFINE SAVE DATA provides the define save data menu which selects the applicable data arrays to be saved.

Title Menu

This menu defines a file name to be saved.

The file title is up to eight characters of alphabet (upper and lower case), figures, etc. If more than eight characters are selected, the last character is written over repeatedly .

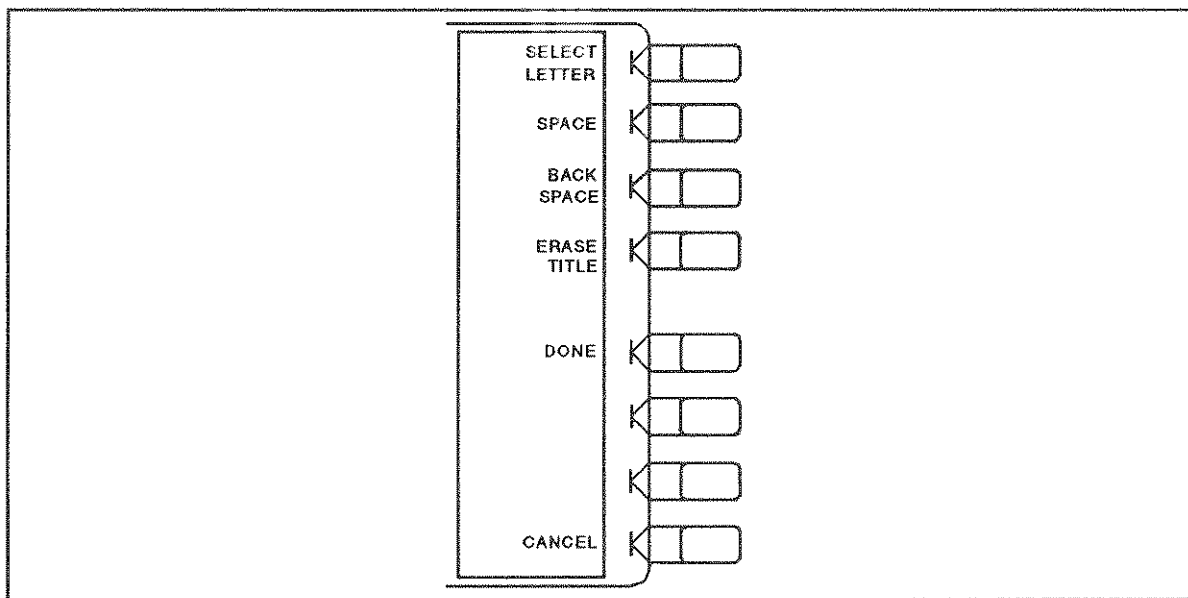

Figure 11-8. Title Menu

SELECT LETTER The active entry area displays the letters of the alphabet, figures, etc. To define a title, rotate the knob until the arrow ↑ points at the desired letter, then press **SELECT LETTER**. Repeat this until the complete file name is defined, for a maximum of eight characters.

SPACE Because the LIF format doesn't allow any spaces in the file name. Don't use this key.

BACK SPACE deletes the last character entered.

ERASE TITLE deletes the entire file name.

DONE saves the data specified in the define save menu and return to the save menu.

CANCEL quits this menu without saving the file, and return to the save menu.

Define Save Data Menu

This menu defines which data arrays are saved on the disk using the **SAVE DATA ONLY** softkey. Refer to “Internal Data Arrays” for description of each data arrays.

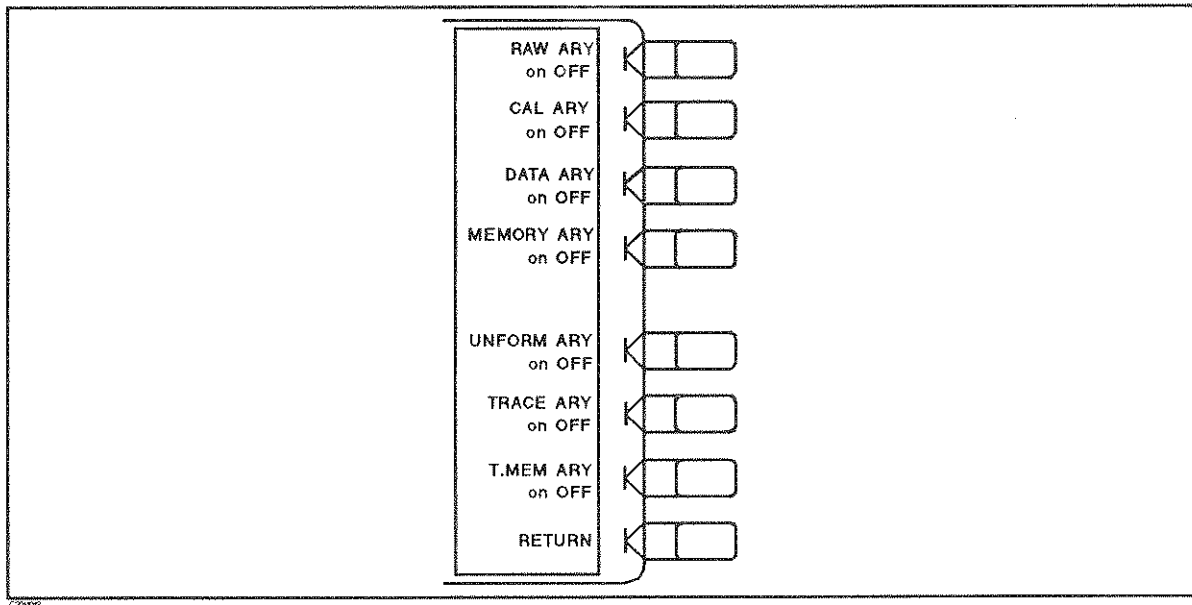

Figure 11-9. Define Save Data Menu

RAW ARY on OFF (SAVRAON, SAVRAOFF) toggles the raw data arrays to be saved or not.

CAL ARY on OFF (SAVCAON, SAVCAOFF) toggles the calibration coefficients arrays to be saved or not.

DATA ARY on OFF (SAVDAON, SAVDAOFF) toggles the data arrays to be saved or not.

MEMORY ARY on OFF (SAVMAON, SAVMAOFF) toggles the memory arrays to be saved or not.

UNFORM ARY on OFF (SAVUAON, SAVUAOFF) toggles the unformat arrays to be saved or not.

TRACE ARY on OFF (SAVTAON, SAVTAOFF) toggles the trace arrays to be saved or not.

T.MEM ARY on OFF (SAVTMAON, SAVTMAOFF) toggles the memory trace arrays to be saved or not.

RETURN returns to the save file menu.

Re-save File Menu

This menu lists the sorted file names, which were previously saved, on the softkey label area and allows updating the file with the current instrument state or data.

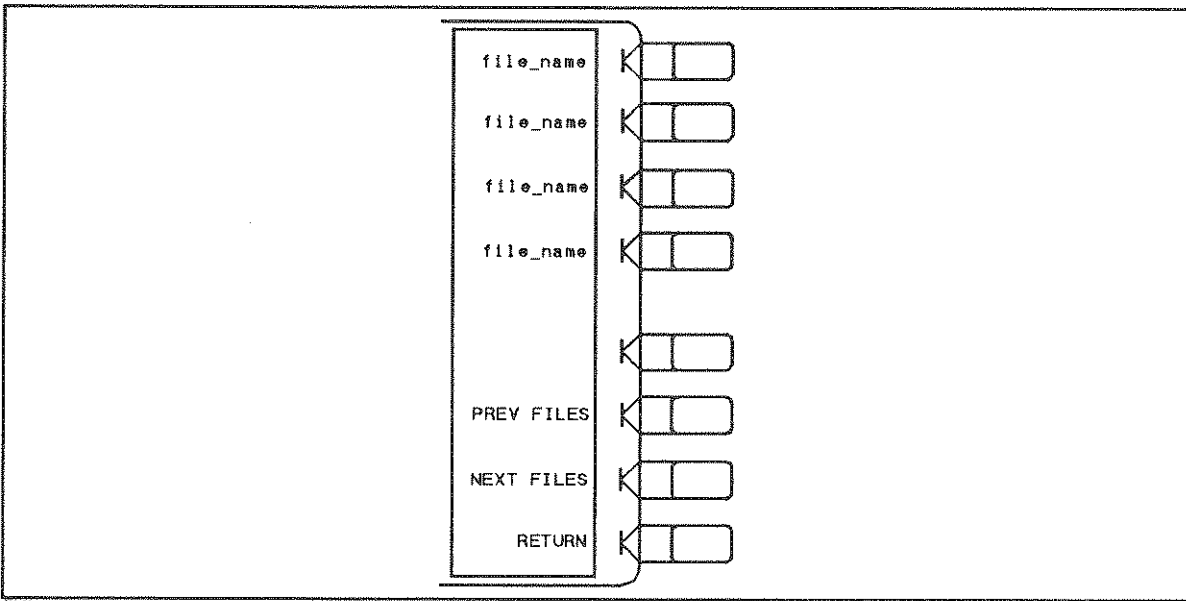

Figure 11-10. Re-save File Menu

file_name updates the file previously saved with the current instrument states or data. The data group to be saved is determined by the file name's extension. Refer to "File Names" for more detail about extension.

PREV FILES displays previous file names in the softkey label to re-save data.

NEXT FILES displays next file names in the softkey label to re-save data.

RETURN returns the save menu.

Disk Menu

This menu provides purge file menu and initialize menu which purges a file, and initializes a disk, respectively.

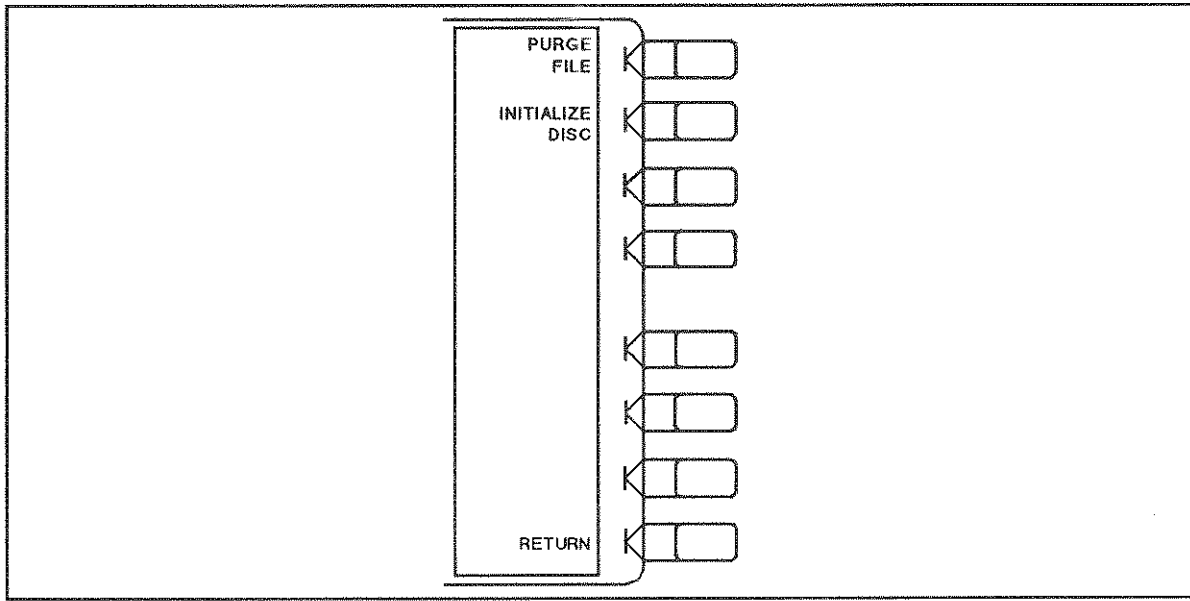

Figure 11-11. Disk Menu

PURGE FILE (PURG) leads to the purge file menu, which removes a file saved on the disk.

INITIALIZE DISK (INID) leads to the initialize menu. Before storing the data on a new disk, the disk must be initialized. The disk format is the Logical Interchange Format (LIF).

RETURN returns to the save menu.

Purge File Menu

This menu lists the sorted file names, which were previously saved, on the softkey label area and allows selecting a file to be removed from the disk.

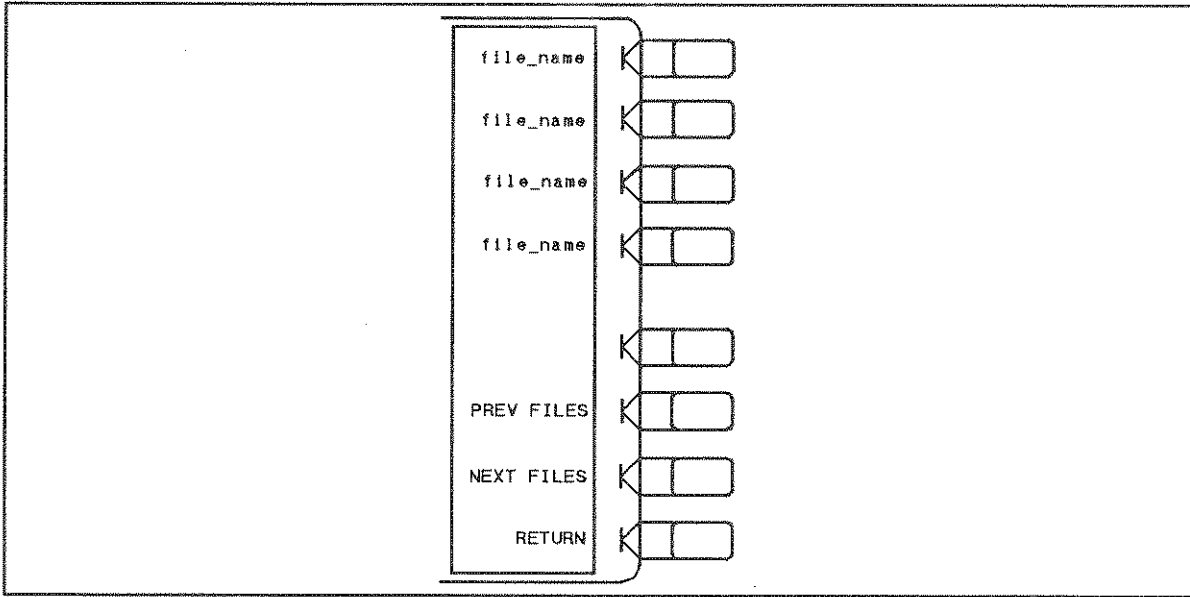

Figure 11-12. Purge File Menu

file_name selects the file name to be removed and provides the purge menu to remove the selected file.

PREV FILES displays set of previous file names in the softkey label area.

NEXT FILES displays next file names in the softkey labels area.

RETURN returns to the disk menu.

Purge Menu

This menu confirms the purge operation and removes the selected file.

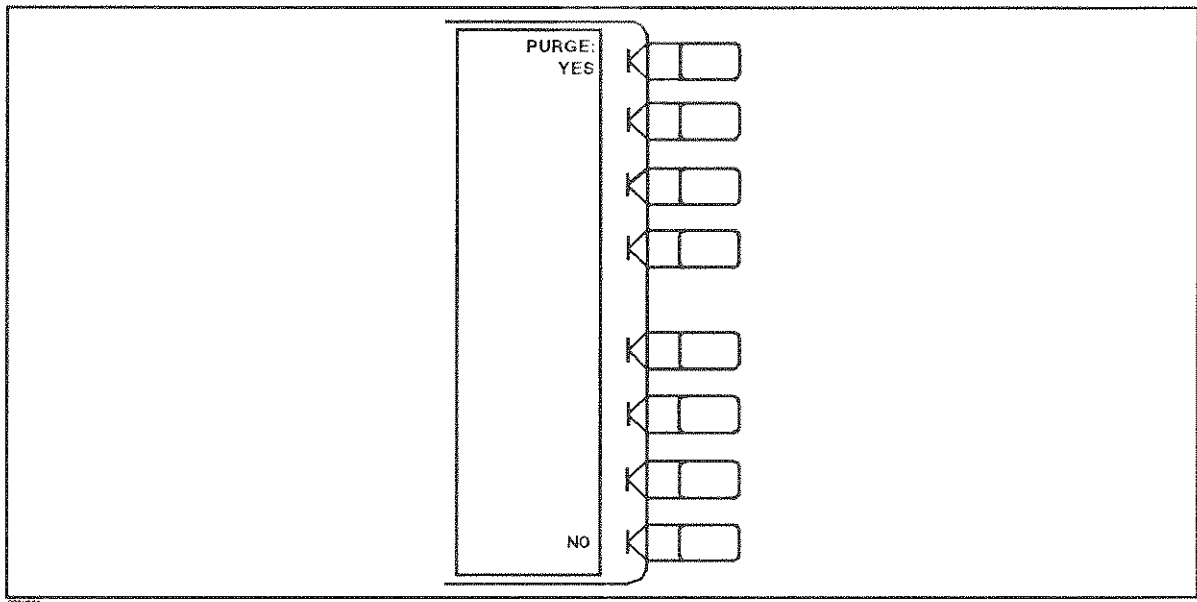

Figure 11-13. Purge Menu

PURGE: YES remove the file and return to the purge file menu.

NO returns to the purge file menu without purging the file.

Initialize Menu

This initializes a disk. A new disk must be initialized with the LIF format before it is used for storage. The LIF format is compatible with HP 9000 series 200/300 computers.

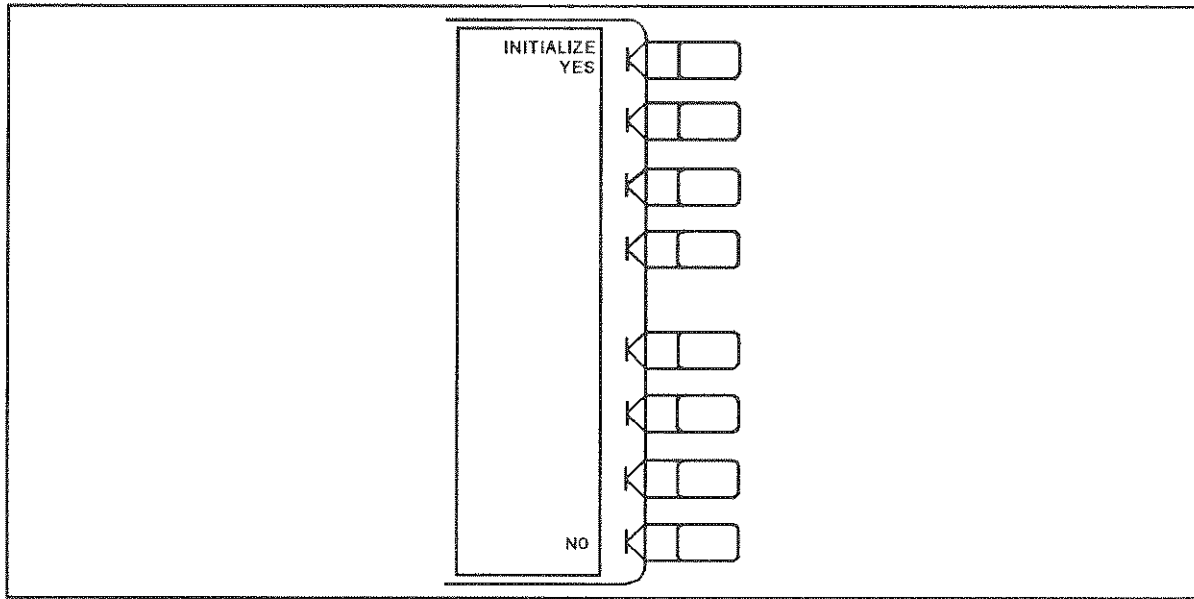

Figure 11-14. Initialize Menu

Caution



If a disk is initialized, all data on the disk is cleared. Be sure no needed data is saved on the disk before initialize a disk.

INITIALIZE YES initializes the disk, then returns to the disk menu.

NO returns to the disk menu without initializing the disk.

Recall Menu

This provides the menus for data recalling or file utilities.

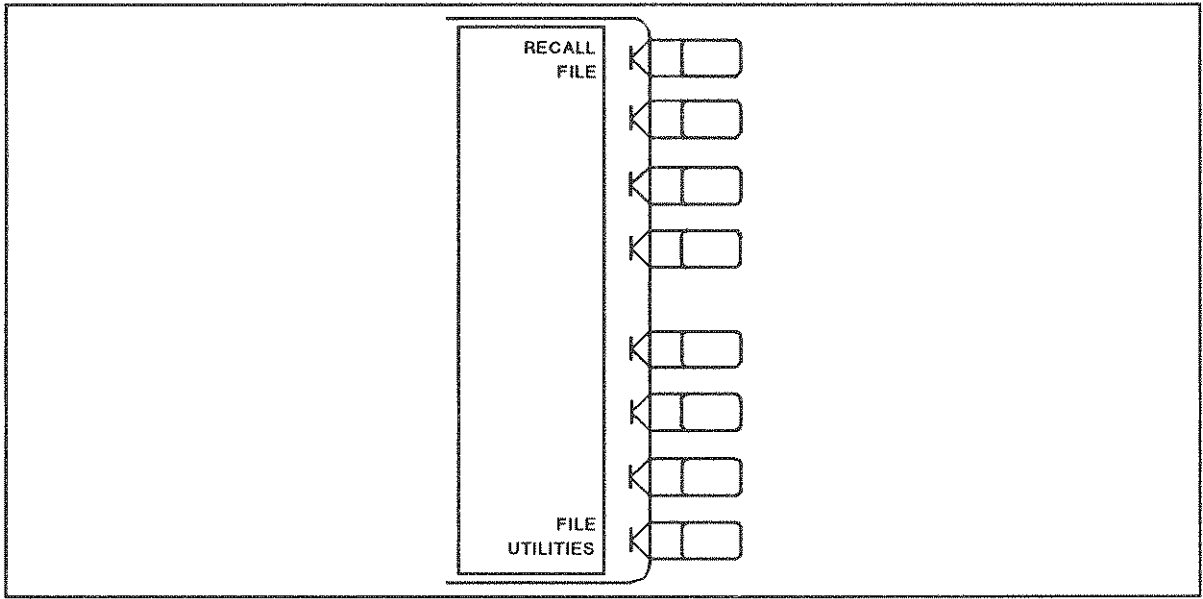

Figure 11-15. Recall Menu

RECALL FILE (RECD) leads to the recall file menu, which loads the instrument states or data from the disk.

FILE UTILITIES leads to the disk menu, which initializes a disk, and purges a file.

Recall File Menu

This menu lists sorted file names, which were previously saved, on the softkey label for selection, and recalls the selected file. The data group to be recalled depends on the file name extension. Refer to “File Names” for more detail.

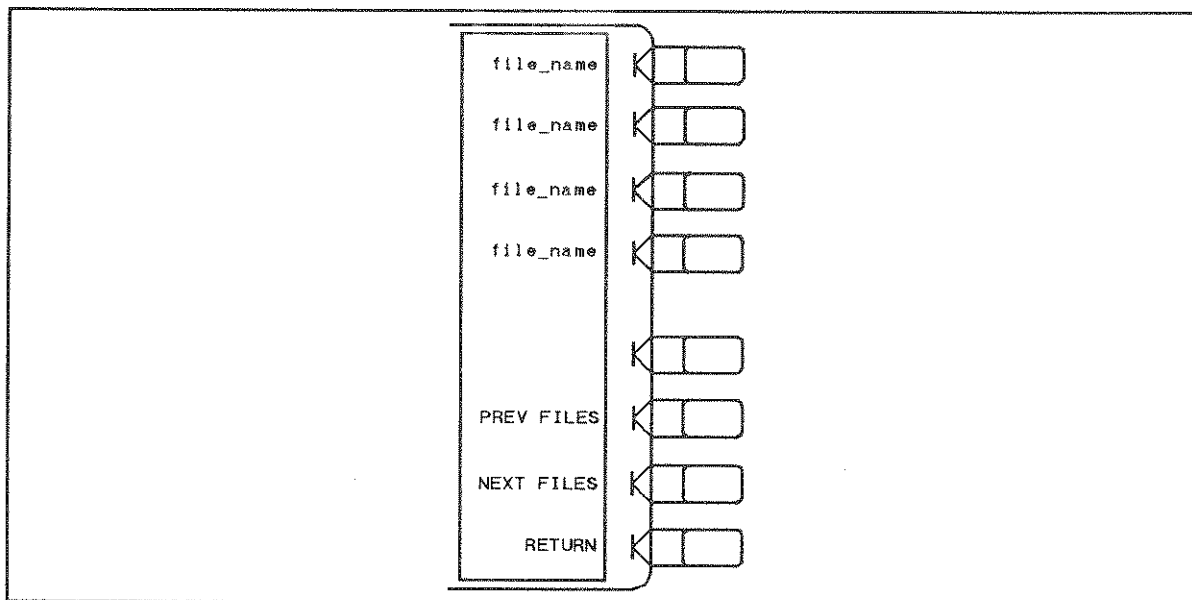

Figure 11-16. Recall File Menu

file_name selects a file to be loaded and loads the instrument state or data.

PREV FILES displays previous set of file names on the softkey label to load data.

NEXT FILES displays next set of file names on the softkey label to load data.

RETURN returns to the recall menu.

Contents

12. HP-IB Remote Programming	
INTRODUCTION	12-1
HOW HP-IB WORKS	12-2
Talker	12-2
Listener	12-2
Controller	12-2
HP-IB REQUIREMENTS	12-2
ANALYZER HP-IB CAPABILITIES	12-3
BUS MODE	12-3
SETTING ADDRESSES	12-4

Figures

12-1. Analyzer Single Bus Concept	12-4
---	------

HP-IB Remote Programming

INTRODUCTION

The analyzer is factory-equipped with a remote programming digital interface using the Hewlett-Packard Interface Bus (HP-IB). (HP-IB is Hewlett-Packard's hardware, software, documentation, and support for IEEE 488.1, IEC-625, IEEE 488.2, and JIS-C1901 worldwide standards for interfacing instruments.) This allows the analyzer to be controlled by an external computer that sends commands or instructions to and receives data from the analyzer using the HP-IB. In this way, a remote operator has the same control of the instrument available to a local operator from the front panel, except for the line power switch.

In addition, the analyzer itself can use HP-IB to directly control compatible peripherals, without the use of an external controller. It can output measurement results directly to a compatible printer or plotter.

This chapter provides an overview of HP-IB operation. Chapter 9 provides information on different controller modes, and on setting up the analyzer as a controller of peripherals. It also explains how to use the analyzer as a controller to print and plot. HP-IB equivalent mnemonics for front panel functions are provided in parentheses throughout this manual.

More complete information on programming the analyzer remotely over HP-IB is provided in *HP-IB Programming Manual*. The *HP-IB Programming Manual* includes examples of remote measurements using an HP 9000 series 200 or 300 computer with BASIC programming. The *HP-IB Programming Manual* assumes familiarity with front panel operation of the instrument.

A complete general description of the HP-IB is available in *Tutorial Description of the Hewlett-Packard Interface Bus*, HP publication 5952-0156. For more information on the IEEE 488.1 standard, refer to *IEEE Standard Digital Interface for Programmable Instrumentation*, published by the Institute of Electrical and Electronics Engineers, Inc., 345 East 47th Street, New York 10017, USA.

HOW HP-IB WORKS

The HP-IB uses a party-line bus structure in which up to 15 devices can be connected on one contiguous bus. The interface consists of 16 signal lines and 6 grounded lines in a shielded cable. With this cabling system, many different types of devices including instruments, computers, plotters and printers can be connected in parallel.

Every HP-IB device must be capable of performing one or more of the following interface functions:

Talker

A talker is a device capable of sending device-dependent data when addressed to talk. There can be only one active talker at any given time. Examples of this type of device are voltmeters, counters, and tape readers. The analyzer is a talker when it sends trace data or marker information over the bus.

Listener

A listener is a device capable of receiving device-dependant data when addressed to listen. There can be any number of active listeners at any given time. Examples of this type of device are printers, power supplies, and signal generators. The analyzer is a listener when it is controlled over the bus by a computer.

Controller

A controller is a device capable of managing the operation of the bus and addressing talkers and listeners. There can be only one active controller at any time. Examples of controllers include desktop computers and minicomputers. In a multiple-controller system, active control can be passed between controllers, but there can only be one *system controller*, which acts as the master, and can regain active control at any time. The analyzer is an active controller when it plots or prints in the addressable mode. The analyzer is a system controller when it is in the system controller mode. These modes are discussed in more detail in "HP-IB Menu" in Chapter 9.

HP-IB REQUIREMENTS

Number of Interconnected Devices:	15 maximum.
Interconnection Path/ Maximum Cable Length:	20 meters maximum or 2 meters per device, whichever is less.
Message Transfer Scheme:	Byte serial/bit parallel asynchronous data transfer using a 3-line handshake system.
Data Rate:	Maximum of 1 megabyte per second over limited distances with tri-state drivers. Actual data rate depends on the transfer rate of the slowest device involved.
Address Capability:	Primary addresses: 31 talk, 31 listen. A maximum of 1 active talker and 14 active listener at one time.

Multiple Controller Capability:

In systems with more than one controller (like the analyzer system), only one can be active at a time. The active controller can pass control to another controller, but only one system controller is allowed.

ANALYZER HP-IB CAPABILITIES

As defined by the IEEE 488.1 standard, the analyzer has the following capabilities:

SH1	Full source handshake.
AH1	Full acceptor handshake.
T6	Basic talker, answers serial poll, unaddresses if MLA is issued. No talk-only mode.
L4	Basic listener, unaddresses if MTA is issued. No listen-only mode.
SR1	Complete service request (SRQ) capabilities.
RL1	Complete remote/local capability including local lockout.
PP0	Does not respond to parallel poll.
DC1	Complete device clear.
DT1	Responds to a group execute trigger.
C1, C2, C3	System controller capabilities in system controller mode.
C10	Pass control capabilities in addressable mode.
E2	Tri-state drivers.

BUS MODE

The analyzer uses a single-bus architecture. The single bus allows both the analyzer and the host controller to have complete access to the peripherals in the system.

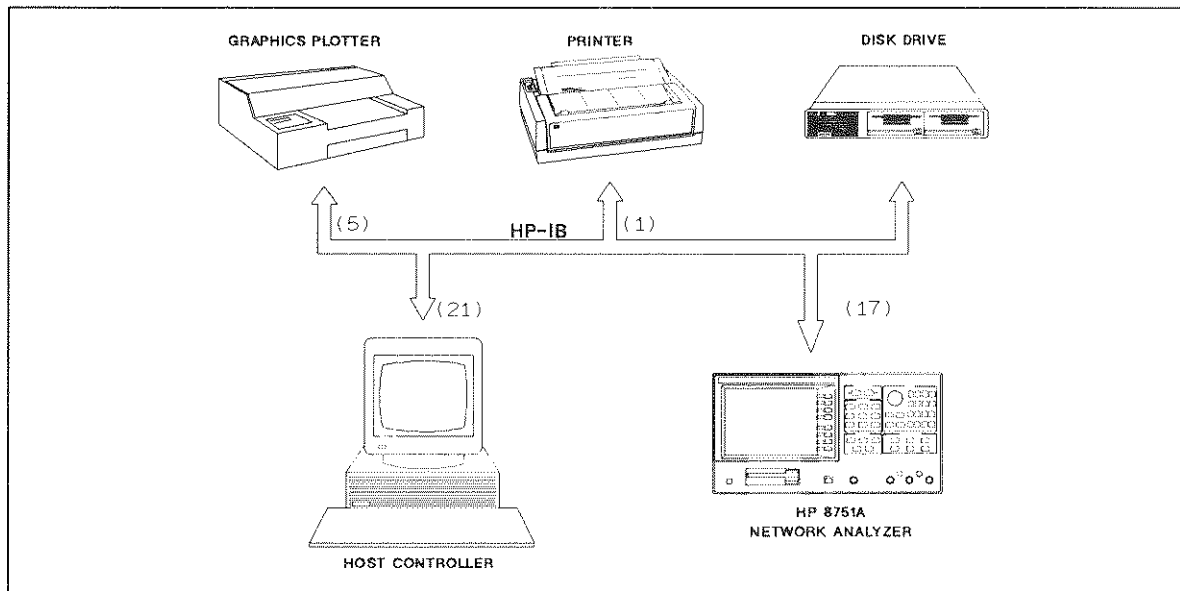

C2012002

Figure 12-1. Analyzer Single Bus Concept

Two different modes are possible, system controller, and addressable.

System Controller	This mode allows the analyzer to control peripherals directly in a stand-alone environment (without an external controller). This mode can only be selected manually from the analyzer front panel. Use this mode for operation when no computer is connected to the analyzer. Printing and plotting use this mode.
Addressable	This is the traditional programming mode, in which the computer is involved in all peripheral access operations. When the external controller is connect the analyzer through HP-IB (as shown in Figure 12-1), this mode allows you to control the analyzer over HP-IB in the talker mode in order to send data, and in the listener mode to receive commands, and also allows the analyzer to take or pass control in order to plot and print.

Chapter 9 explains the two different bus modes in detail, and provides information on setting the correct bus mode. Programming information for the addressable mode is provided in the *HP-IB Programming Manual*.

SETTING ADDRESSES

In communications though HP-IB, each instrument on the bus is identified by an HP-IB address. This address code must be different for each instrument on the bus. Refer to "Address Menu" in Chapter 9 for information on default addresses, and on setting and changing addresses. These addresses are not affected when you press **PRESET** or cycle the power.

Contents

A. Default	
PRESET STATE	A-1
PREDEFINED CALIBRATION KIT	A-6
Predefined Standards	A-6
Predefined Standard Class Assignments	A-8
B. Menu Map	
INTRODUCTION	B-1
C. I/O Port	
I/O PORT	C-1
Pin Assignment	C-1
Related HP-IB Commands	C-2
Using The I/O Port Without an External Controller nor Instrument BASIC	C-2
D. Manual Changes	
INTRODUCTION	D-1
MANUAL CHANGES	D-1

Figures

B-1. Operating Softkey Menu Map (1 of 5)	B-1
B-2. Operating Softkey Menu Map (2 of 5)	B-2
B-3. Operating Softkey Menu Map (3 of 5)	B-3
B-4. Operating Softkey Menu Map (4 of 5)	B-4
B-5. Operating Softkey Menu Map (5 of 5)	B-5
C-1. I/O Port Pin Assignments	C-1
C-2. An Example of a Test System Without Controller	C-2

Tables

A-1. Preset Conditions	A-1
A-2. Preset conditions	A-2
A-3. Preset conditions	A-3
A-4. Preset conditions	A-4
A-5. Preset conditions	A-5
A-6. Results of Power Loss to Battery Backup Memory (Factory Setting)	A-6
A-7. 7 mm Standard Cal Kit	A-6
A-8. 50 Ω Type-N Standard Cal Kit	A-7
A-9. 75 Ω Type-N Standard Cal Kit	A-7
A-10. Standard Class Assignments Table (7 mm)	A-8
D-1. Manual Changes by Serial Number	D-1
D-2. Manual Changes by Firmware's Version	D-1

Default

PRESET STATE

When the **PRESET** key is pressed, or the analyzer is turned on, the analyzer reverts to a known state. There are subtle differences between the preset state and the power-up state, and these states are defined in Table A-1 to Table A-5.

Some power-up states are recalled from non-volatile memory (battery backup memory). If power to the non-volatile memory is lost, the analyzer will have certain parameters set to factory settings. Table A-6 lists the factory settings. The operating time of the battery backup memory is approximately 72 hours. The battery is automatically recharged while the instrument is on. The recharge time (time required to fully recharge the battery) is approximately 10 minutes.

When line power is cycled the analyzer performs a self-test routine. Upon successful completion of the self-test routine, the instrument state is set to the following preset conditions. The same conditions are true following a “PRES” or “*RST” command over the HP-IB bus.

Table A-1. Preset Conditions

Operating Parameter	Initialize Method	
	Power On	PRESET key
Stimulus Conditions		
Sweep Type	Linear frequency	Linear Frequency
Display Mode	Start/Stop	Start/Stop
Trigger Type	Continuous	Continuous
External Trigger	Off	Off
Sweep Time	80.4 ms	80.4 ms
Start Frequency	5 Hz (or 100 kHz ¹)	5 Hz (or 100 kHz ¹)
Frequency Span	499.999995 MHz (or 499.9 MHz ¹)	499.999995 MHz (or 499.9 MHz ¹)
CW frequency	100 MHz	100 MHz
Source Power	0 dBm	0 dBm
Start Power	-50 dBm	-50 dBm
Stop Power	-15 dBm	-50 dBm
Power trip	Clear	Clear
Coupled Channels	On	On
Frequency List		
Frequency List	Empty	Empty
Edit Mode	Start/Stop, Number of Points	Start/Stop, Number of Points

¹ when S-parameter test set is connected

Table A-2. Preset conditions

Operating Parameter	Initialize Method	
	Power On	PRESET key
Response Conditions		
Parameter		
Channel 1	A/R (or S_{11}^1)	A/R (or S_{11}^1)
Channel 2	B/R (or S_{21}^1)	B/R (or S_{21}^1)
Conversion	Off	Off
Format	Log magnitude (all inputs)	Log magnitude (all inputs)
Display	Data	Data
Dual Channel	Off	Off
Active Channel	Channel 1	Channel 1
Frequency Blank	Disabled	Disabled
Split Display	On	On
Intensity	83 %	No effect (same as before preset)
Background Intensity	0 %	No effect (same as before preset)
Color Selections		
Channel 1 Data	Yellow	No effect (same as before preset)
Channel 1 Memory	Green	No effect (same as before preset)
Channel 2 Data	Blue	No effect (same as before preset)
Channel 2 Memory	Pink	No effect (same as before preset)
Graticule	Gray	No effect (same as before preset)
Warning	Red	No effect (same as before preset)
Text	White	No effect (same as before preset)
Beeper:Done	On	On
Beeper:Warning	Off	Off
Title	Empty	Empty
Number of Points	201	201
IF Bandwidth	4 kHz	4 kHz
IF Averaging Factor	16; Off	16; Off
Smoothing Aperture	1% Span; Off	1% Span; Off
Group Delay Aperture	1% Span	1% Span
Phase Offset	0°	0°
Electrical Delay	0 s	0 s
Conjugate Matching	Off	Off

1 when S-parameter test set is connected

Table A-3. Preset conditions

Operating Parameter	Initialize Method	
	Power On	PRESET key
Calibration		
Correction	Off	Off
Calibration Type	None	None
Calibration Kit	7 millimeter	7 millimeter
System Impedance	50 Ω	50 Ω
Velocity Factor	1	1
Extensions	Off	Off
Port 1	0 s	0 s
Port 2	0 s	0 s
Input R	0 s	0 s
Input A	0 s	0 s
Input B	0 s	0 s
Scale		
Log Magnitude	10 dB	10 dB
Phase	90°	90°
Group Delay	10 nsec	10 nsec
Smith Chart	1	1
Polar Chart	1	1
Linear Magnitude	0.1	0.1
SWR	1	1
Real	0.2	0.2
Imaginary	0.2	0.2
Reference Line Position		
Log Magnitude	5 dB	5 dB
Phase	5°	5°
Group Delay	5 nsec	5 nsec
Smith Chart	-	-
Polar Chart	-	-
Linear Magnitude	0	0
SWR	1	1
Real	5	5
Imaginary	5	5
Reference Value		
Log Magnitude	0 dB	0 dB
Phase	0°	0°
Group Delay	0 nsec	0 nsec
Smith Chart	1	1
Polar Chart	1	1
Linear Magnitude	0	0
SWR	1	1
Real	0	0
Imaginary	0	0

Table A-4. Preset conditions

Operating Parameter	Initialize Method	
	Power On	(PRESET) key
Markers		
Markers 1,2,3,4,5,6,7,8	5 Hz (or 100 kHz ¹) all markers off	5 Hz (or 100 kHz ¹) all markers off
Markers On	Data	Data
Active Marker	1	1
Reference Marker	None	None
Marker Mode	Continuous	Continuous
Delta Marker Mode	Off	Off
Coupling	On	On
Marker List	Off	Off
Marker Time	Off	Off
Marker Search	Off	Off
Marker Target Value	-3 dB	-3 dB
Marker Width Value	-3 dB; Off	-3 dB; Off
Marker Tracking	Off	Off
Marker Stimulus Offset	0 Hz	0 Hz
Marker Value Offset	0 dB	0 dB
Marker Aux Offset (Phase)	0°	0°
Marker Statistics	Off	Off
Polar Marker	LIN MKR	LIN MKR
Smith Marker	R+jX	R+jX
Limit Lines		
Limit Lines	Off	Off
Limit Testing	Off	Off
Limit Line Table	Clear	No effect (Same as before preset)
Edit Mode	Upper/Lower Limits	Upper/Lower Limits
Stimulus Offset	0 Hz	0 Hz
Amplitude Offset	0 dB	0 dB
Beep Fail	Off	Off

¹ when S-parameter test set is connected

Table A-5. Preset conditions

Operating Parameter	Initialize Method	
	Power On	PRESET key
System Parameters		
HP-IB Addresses	Battery backup memory	No effect (same as before preset)
HP-IB Mode	Addressable mode	No effect (same as before preset)
Input Attenuation		
Input A	20 dB	20 dB
Input B	20 dB	20 dB
Input R	20 dB	20 dB
Test Set	The analyzer checks for presence of HP 87511A/B or HP 85046A/B	The analyzer checks for presence of HP 87511A/B or HP 85046A/B
Test Set Attenuation		
Port 1	0 dB	0 dB
Port 2	0 dB	0 dB
Plot		
Copy Time	Off	Off
Define Plot	All	All
Plot Quadrant	Full page	Full page
Scale Plot	Full	Full
Plot Speed	Fast	Fast
Line Type for Data	7 (solid)	7 (solid)
Line Type for Memory	7 (solid)	7 (solid)
Print	Standard	Standard
Pen Number		
Channel 1		
Data	1	1
Memory	5	5
Graticule	3	3
Text	1/4/5	1/4/5
Marker	1/5	1/5
Channel 2		
Data	2	2
Memory	6	6
Graticule	3	3
Text	4	4
Marker	2/4/6	2/4/6

Table A-6.
Results of Power Loss to Battery Backup Memory (Factory Setting)

Parameter	Factory Setting
HP-IB Address, HP 8751A	17
HP-IB Address, Plotter	5
HP-IB Address, Printer	1
HP-IB Address, Controller	21
DC Detect or Calibration Coefficients	Reset
Calibration Kit Definitions	Factory set default (Refer to Table A-7 to Table A-12.)

PREDEFINED CALIBRATION KIT

Predefined Standards

Table A-7. 7 mm Standard Cal Kit

NO.	STANDARD TYPE	C0 $\times 10^{-15} \text{F}$	C1 $\times 10^{-27} \text{F/Hz}$	C2 $\times 10^{-36} \text{F/Hz}^2$	OFFSET DELAY ps	OFFSET LOSS M Ω /s	OFFSET Z ₀ Ω	STANDARD LABEL
1	SHORT				0	700	50	SHORT
2	OPEN	92.85	0	7.2	0	700	50	OPEN
3	LOAD				0	700	50	BROADBAND
4	DELAY/THRU				0	700	50	THRU
5	LOAD				0	700	50	SLIDING
6	LOAD				0	700	50	LOWBAND
7	SHORT				0	700	50	
8	OPEN	79.4	0	40	0	700	50	OPEN

Table A-8. 50 Ω Type-N Standard Cal Kit

NO.	STANDARD TYPE	C0 $\times 10^{-15} \text{F}$	C1 $\times 10^{-27} \text{F/Hz}$	C2 $\times 10^{-36} \text{F/Hz}^2$	OFFSET DELAY ps	OFFSET LOSS MΩ/s	OFFSET Z ₀ Ω	STANDARD LABEL
1	SHORT				0	700	50	SHORT[M]
2	OPEN	108	55	130	0	700	50	OPEN[M]
3	LOAD				0	700	50	BROADBAND
4	DELAY/THRU				0	700	50	THRU
5	LOAD				0	700	50	SLIDING
6	LOAD				0	700	50	LOWBAND
7	SHORT				17.544	700	50	SHORT[F]
8	OPEN	62	17	28	17.544	700	50	OPEN[F]

Table A-9. 75 Ω Type-N Standard Cal Kit

NO.	STANDARD TYPE	C0 $\times 10^{-15} \text{F}$	C1 $\times 10^{-27} \text{F/Hz}$	C2 $\times 10^{-36} \text{F/Hz}^2$	OFFSET DELAY ps	OFFSET LOSS MΩ/s	OFFSET Z ₀ Ω	STANDARD LABEL
1	SHORT				0	1.13×10^3	75	SHORT[M]
2	OPEN	63.5	84	56	0	1.13×10^3	75	OPEN[M]
3	LOAD				0	1.13×10^3	75	BROADBAND
4	DELAY/THRU				0	1.13×10^3	75	THRU
5	LOAD				0	1.13×10^3	75	SLIDING
6	LOAD				0	1.13×10^3	75	LOWBAND
7	SHORT				17.544	1.13×10^3	75	SHORT[F]
8	OPEN	41	40	5	17.544	1.13×10^3	75	OPEN[F]

Predefined Standard Class Assignments

Table A-10. Standard Class Assignments Table (7 mm)

CLASS	A	B	C	D	E	F	G	STANDARD CLASS LABEL
S _{11A}	2							OPEN
S _{11B}	1							SHORT
S _{11C}	3							LOAD
S _{22A}	2							OPEN
S _{22B}	1							SHORT
S _{22C}	3							LOAD
Forward Transmission	4							THRU
Reverse Transmission	4							THRU
Forward Match	4							THRU
Reverse Match	4							THRU
Response	1	2	4					RESPONSE
Response & Isolation	1	2	4					RESPONSE

Table A-11. Standard Class Assignments Table (50 Ω Type-N)

CLASS	A	B	C	D	E	F	G	STANDARD CLASS LABEL
S _{11A}	2	8						OPENS
S _{11B}	1	7						SHORTS
S _{11C}	3							LOAD
S _{22A}	2	8						OPENS
S _{22B}	1	7						SHORTS
S _{22C}	3							LOAD
Forward Transmission	4							THRU
Reverse Transmission	4							THRU
Forward Match	4							THRU
Reverse Match	4							THRU
Response	1	7	2	8	4			RESPONSE
Response & Isolation	1	7	2	8	4			RESPONSE

Table A-12. Standard Class Assignments Table (75 Ω Type-N)

CLASS	A	B	C	D	E	F	G	STANDARD CLASS LABEL
S _{11A}	2	8						OPENS
S _{11B}	1	7						SHORTS
S _{11C}	3							LOAD
S _{22A}	2	8						OPENS
S _{22B}	1	7						SHORTS
S _{22C}	3							LOAD
Forward Transmission	4							THRU
Reverse Transmission	4							THRU
Forward Match	4							THRU
Reverse Match	4							THRU
Response	1	7	2	8	4			RESPONSE
Response & Isolation	1	7	2	8	4			RESPONSE

Menu Map

INTRODUCTION

The following figures show the structure of the analyzer's softkey menus.

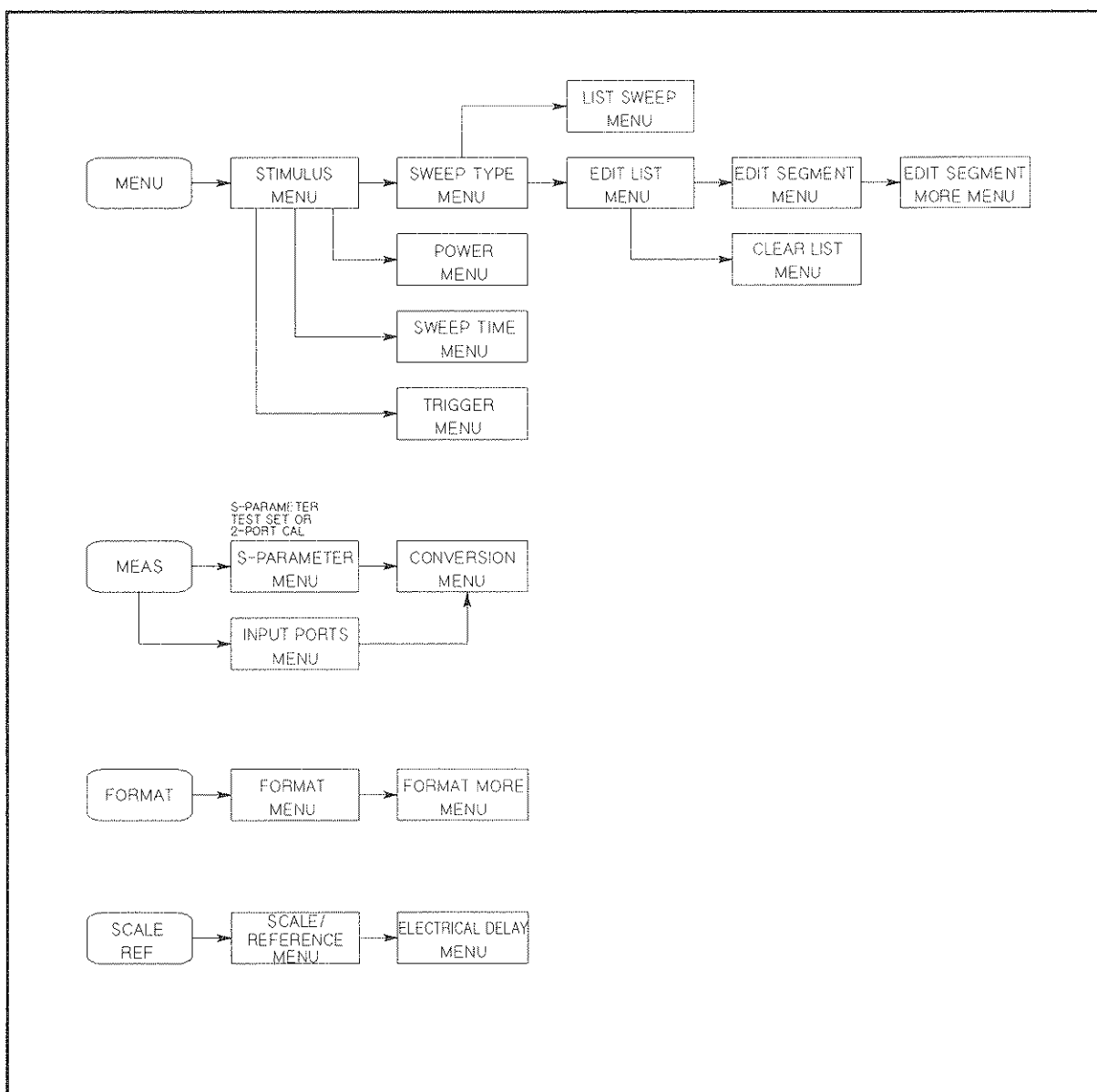

C200B001

Figure B-1. Operating Softkey Menu Map (1 of 5)

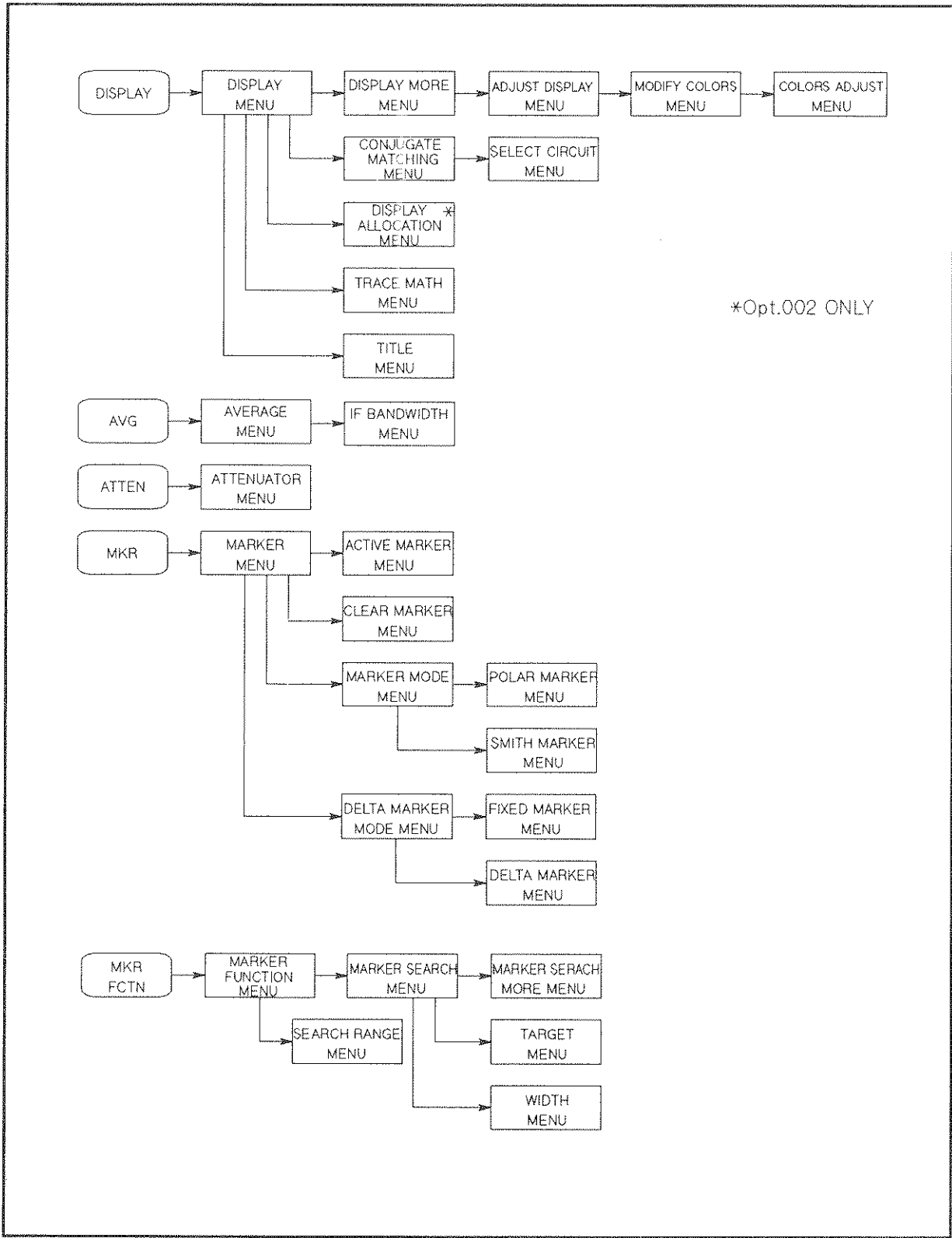

C200B002

Figure B-2. Operating Softkey Menu Map (2 of 5)

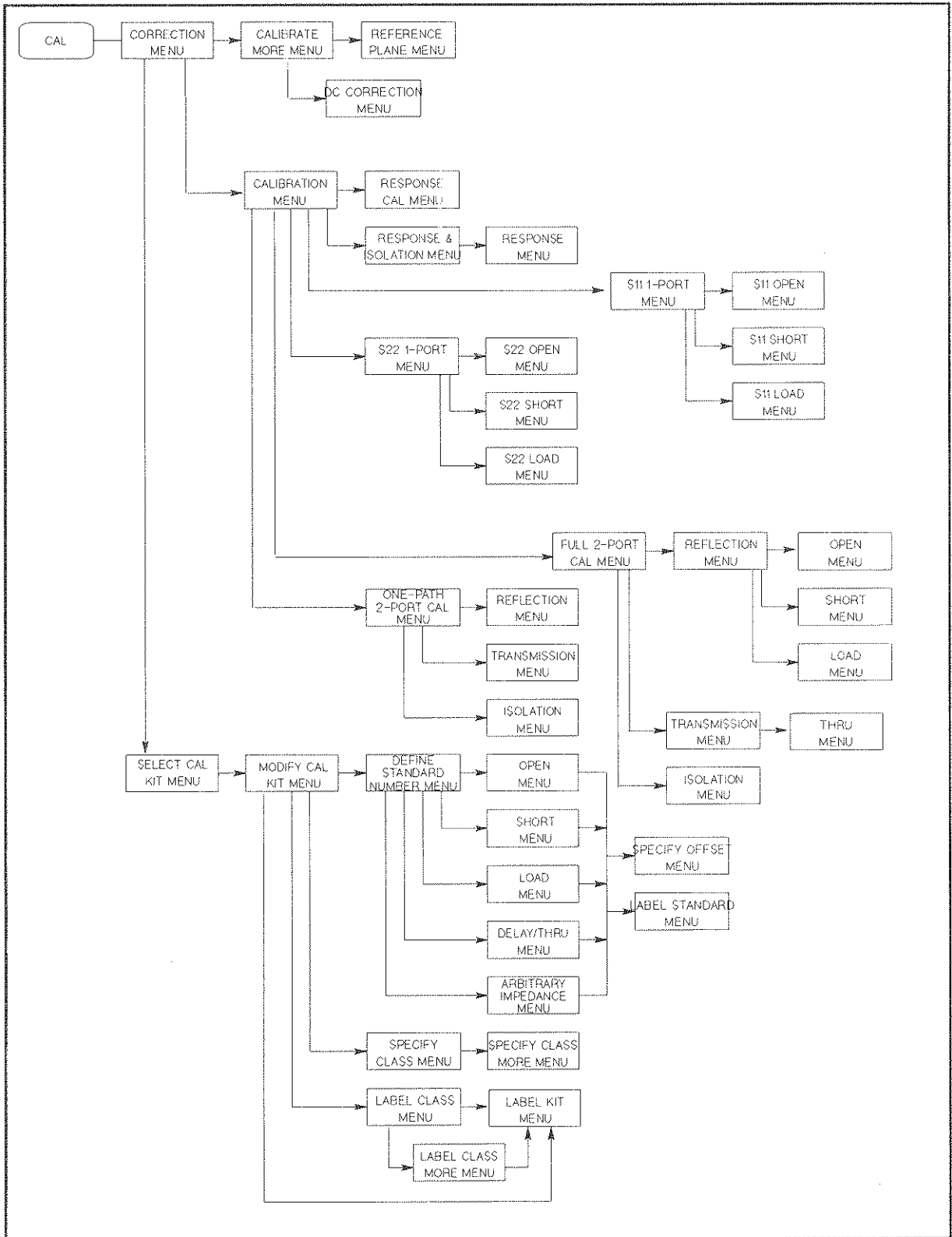

C2008.003

Figure B-3. Operating Softkey Menu Map (3 of 5)

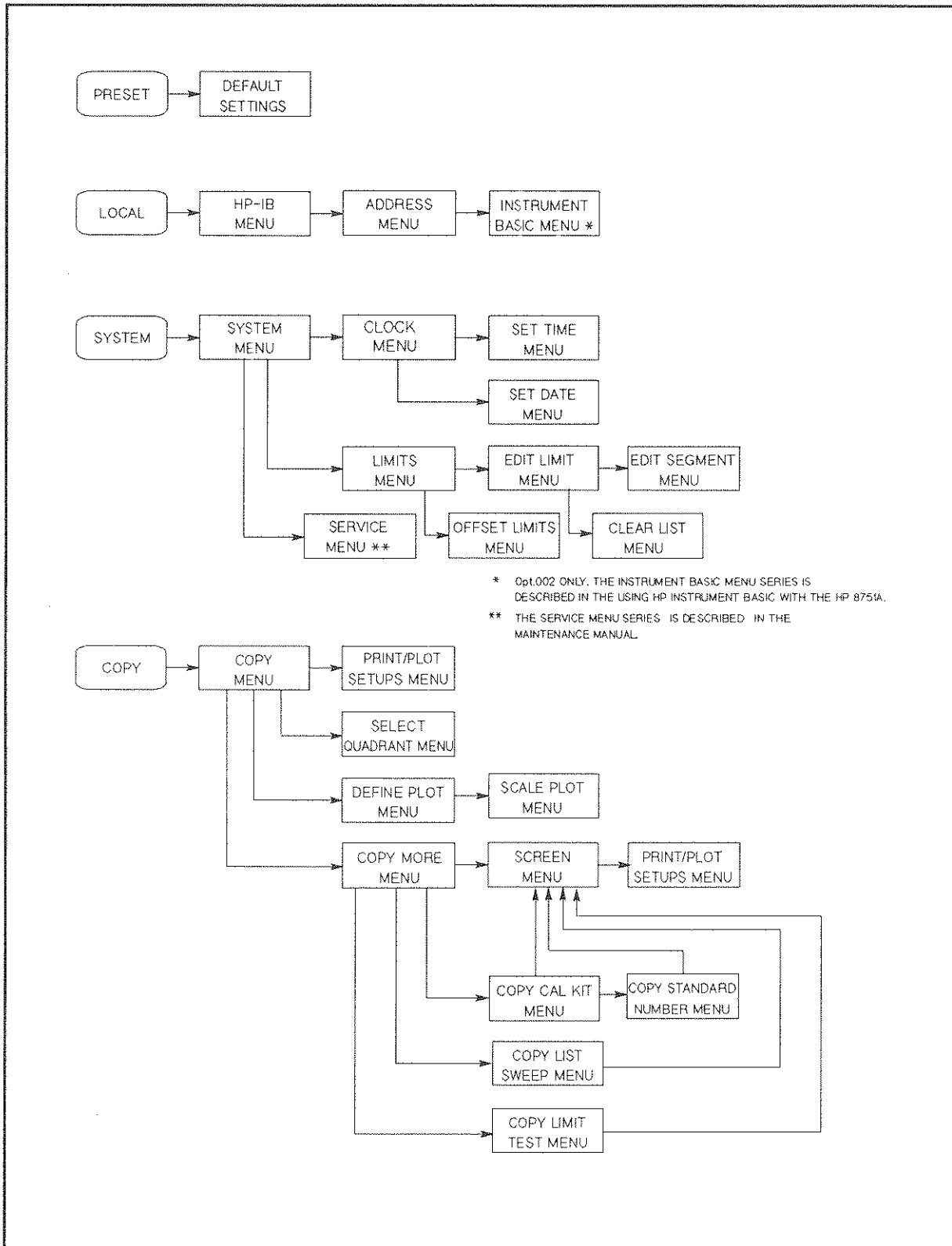

C200B004

Figure B-4. Operating Softkey Menu Map (4 of 5)

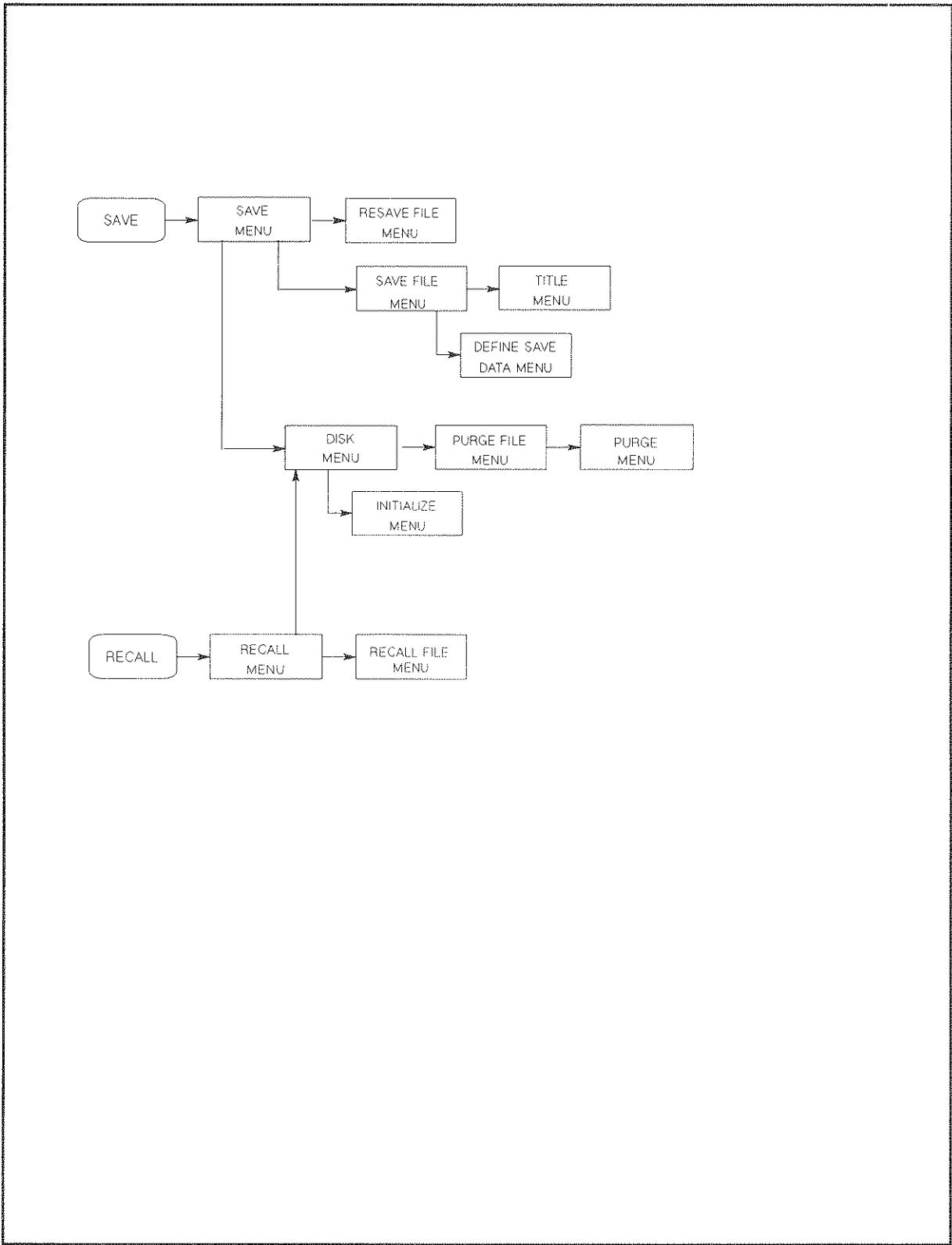

C200B005

Figure B-5. Operating Softkey Menu Map (5 of 5)

I/O Port

I/O PORT

The I/O port on the analyzer rear panel communicates with the external devices such as a handler on a production line, for example.

Pin Assignment

The I/O port consists of 15 TTL compatible signals, which are 8-bit output, 4-bit input, sweep end, pass/fail, and ground. The pin assignments are shown in Figure C-1.

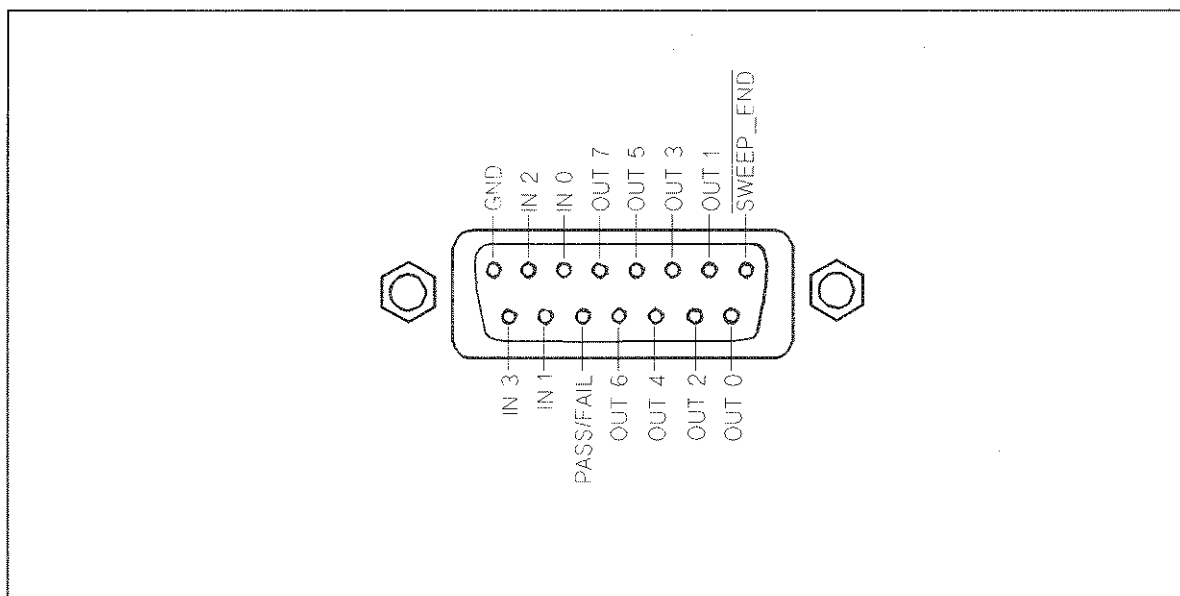

C2000001

Figure C-1. I/O Port Pin Assignments

The signals carried through each pin are described below.

SWEEP_END outputs a negative pulse when the analyzer completes a sweep. The pulse width is > 160 ns.

OUT 0 thru 7 output signals to external devices and are controlled by two HP-IB commands, OUT8IO, as described below. Once OUT8IO is executed, the signal is latched, and until OUT8IO is executed again.

IN 0 thru 4 input signals from external devices and are read by the HP-IB command INP8IO, as described below.

PASS/FAIL is affected only when the Limit Testing, described in "LIMIT LINE AND LIMIT TESTING" in Chapter 9, is active. This signal presents HIGH and LOW if the test result is PASS and FAIL, respectively.

Related HP-IB Commands

There are three HP-IB commands which directly control the I/O port.

OUT8IO outputs 8-bit data to the OUT 0 thru 7 lines. The OUT 0 signal is the LSB (least significant bit), while the OUT 7 signal is the MSB (most significant bit).

INP8IO inputs 4-bit data from the IN 0 thru 3 signals to the analyzer's memory. The IN 0 signal is the LSB (least significant bit), while the IN 3 signal is the MSB (most significant bit).

OUTPINP8IO? is a query command which outputs 8 bit data to the controller. The data is obtained as 4 bits by the INP8IO command and attaches the four bit as the upper bits to extend the 4 bit data to 8 bit data. The four upper significant bits (four bits from MSB) of 8 bit are set to zero.

Using The I/O Port Without an External Controller nor Instrument BASIC

The I/O port can be used without an external controller nor Instrument BASIC (Opt. 002). Figure C-2 shows an example of a test system using no external controller nor the Instrument BASIC capability.

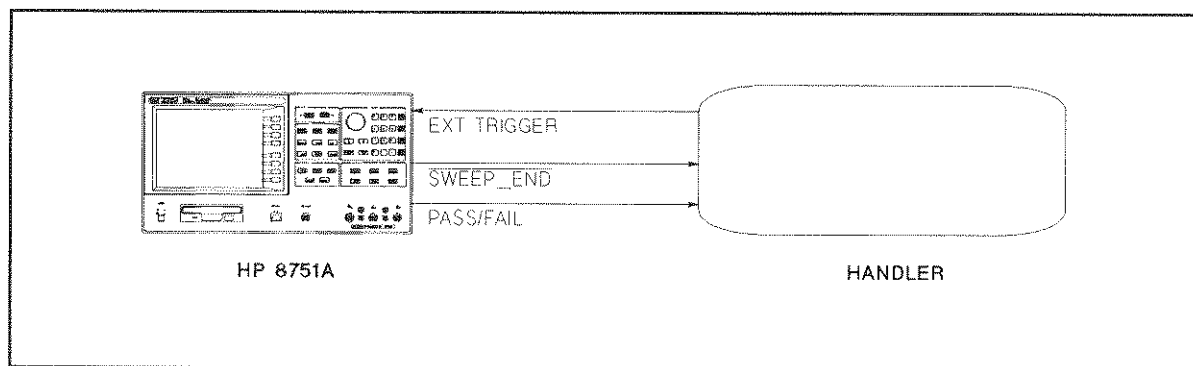

Figure C-2. An Example of a Test System Without Controller

The testing procedure using this system will be as follows.

1. The handler contacts the DUT.
2. The handler outputs a positive going pulse to trigger the analyzer. (See *General Information* section for more details on the external trigger signal.)
3. The analyzer measures the DUT, and outputs a *SWEEP_END* signal. If the limit test is set to be on, the analyzer also outputs the PASS/FAIL signal to the I/O port.
4. The handler distinguishes if the DUT passes or fails the test, and puts the DUT into the proper bin.
5. Return to the step 1.

Manual Changes

INTRODUCTION

This appendix contains the information required to adapt this manual to earlier versions or configurations of the HP 8751A than the current printing date of this manual. The information in this manual applies directly to HP 8751A Network Analyzer whose serial number prefix is listed on the title page of this manual.

MANUAL CHANGES

To adapt this manual to your HP 8751A, refer to Table D-1 and Table D-2, and make all of the manual changes listed opposite your instrument's serial number and ROM-based firmware's version.

Instruments manufactured after the printing of this manual may be different than those documented in this manual. Later instrument versions will be documented in a manual changes supplement that will accompany the manual shipped with that instrument. If your instrument serial number is not listed on the title page of this manual or in Table D-1, it may be documented in a *yellow MANUAL CHANGES* supplement.

Turn on the line switch or execute the “*IDN?” command via HP-IB for confirmation of the ROM-based firmware's version. Refer to HP-IB Programming Manual for the information of the “*IDN?”. For additional information on serial number coverage, refer to Chapter 1 in General Information.

Table D-1. Manual Changes by Serial Number

Serial Prefix or Number	Make Manual Changes
	There are no earlier configurations than the printing date of this manual.

Table D-2. Manual Changes by Firmware's Version

Version	Make Manual Changes
	There are no earlier versions than the printing date of this manual.

Contents

Messages

ERROR MESSAGES IN ALPHABETICAL ORDER	Messages-1
ERROR MESSAGES IN NUMERICAL ORDER	Messages-14

Error Messages

This section lists the error messages that may be displayed on the analyzer display or transmitted by the instrument over HP-IB. Each error message is accompanied by an explanation, and suggestions are provided to help in solving the problem. Where applicable, references are given to related sections of the Operation and Maintenance manuals.

When displayed, error messages are usually preceded with the word "CAUTION:". That part of the error message has been omitted here for the sake of brevity. Some messages are for information only, and do not indicate an error condition. Two listings are provided: the first is in alphabetical order, and the second in numerical order.

In addition to error messages, instrument status is indicated by status notations in the left margin of the display. Examples are "*", "mSH", and "P|". Sometimes these appear in conjunction with error messages. A complete listing of status and notations and their meanings is provided in "CRT DISPLAY" in Chapter 2.

ERROR MESSAGES IN ALPHABETICAL ORDER

159 +12V OUT OF SPEC

Severe error. Contact your nearest Hewlett-Packard office.

160 +15V(A) OUT OF SPEC

Severe error. Contact your nearest Hewlett-Packard office.

157 +18V OUT OF SPEC

Severe error. Contact your nearest Hewlett-Packard office.

161 +22V OUT OF SPEC

Severe error. Contact your nearest Hewlett-Packard office.

162 +65V OUT OF SPEC

Severe error. Contact your nearest Hewlett-Packard office.

156 -12.6V OUT OF SPEC

Severe error. Contact your nearest Hewlett-Packard office.

155 -15V OUT OF SPEC

Severe error. Contact your nearest Hewlett-Packard office.

192 1st IF OFFSET OSC TEST FAILED

Severe error. Contact your nearest Hewlett-Packard office.

190 1st LOCAL AMP TEST FAILED

Severe error. Contact your nearest Hewlett-Packard office.

186 1st LOCAL MIXER LOCAL PORT ALC TEST FAILED

Severe error. Contact your nearest Hewlett-Packard office.

149 A1 CPU EXT BUS TEST FAILED

Severe error. Contact your nearest Hewlett-Packard office.

141 A1 ROM TEST FAILED

Severe error. Contact your nearest Hewlett-Packard office.

A40 HEAT SINK TOO HOT

The temperature sensors on the A4 post-regulator assembly have detected an over-temperature condition. Power off and cool down the instrument for approximately 10 minutes. If this message is displayed again, contact your nearest Hewlett-Packard office.

165 Ach +5V(A)/2 OUT OF SPEC

Severe error. Contact your nearest Hewlett-Packard office.

173 Ach A/D LINEARITY POOR

Severe error. Contact your nearest Hewlett-Packard office.

166 Ach A/D REF VOLTAGE OUT OF SPEC

Severe error. Contact your nearest Hewlett-Packard office.

170 Ach RECEIVER FUNCTIONALLY POOR

Severe error. Contact your nearest Hewlett-Packard office.

176 Ach/Rch IF GAIN OUT OF SPEC

Severe error. Contact your nearest Hewlett-Packard office.

6 ADDITIONAL STANDARD NEEDED

Error correction for the selected calibration class cannot be computed until all the necessary standards have been measured.

14 BACKUP DATA LOST

Data check-sum error on the battery backup memory has occurred. The battery is recharged for approximately 10 minutes after power on.

143 BACKUP RAM TEST FAILED

Severe error. Contact your nearest Hewlett-Packard office.

167 Bch -5.2V(A)/2 OUT OF SPEC

Severe error. Contact your nearest Hewlett-Packard office.

174 Bch A/D LINEARITY POOR

Severe error. Contact your nearest Hewlett-Packard office.

168 Bch A/D REF VOLTAGE OUT OF SPEC

Severe error. Contact your nearest Hewlett-Packard office.

171 Bch RECEIVER FUNCTIONALLY POOR

Severe error. Contact your nearest Hewlett-Packard office.

177 Bch/Rch IF GAIN OUT OF SPEC

Severe error. Contact your nearest Hewlett-Packard office.

-160 Block data error

Block data is improper.

-168 Block data not allowed

Block data is not allowed.

9 CALIBRATION ABORTED

The calibration in progress was terminated due to change of the active channel or stimulus parameters.

7 CALIBRATION REQUIRED

No valid calibration coefficients were found, when user attempted to turn calibration on. Refer to Chapter 7.

60 CAN'T CHANGE-ANOTHER CONTROLLER ON BUS

The analyzer cannot assume the mode of system controller until the active controller is removed from the bus or relinquishes the bus.

-148 Character data not allowed

Character data not allowed for this operation.

-144 Character data too long

Character data is too long (maximum length is 12 characters).

136 CONTINUOUS SWITCHING NOT ALLOWED

The current measurement requires the S-parameter test set to switch automatically between forward and reverse measurements (driving test port 1 and, then test port 2). Refer to Chapter 5.

-253 CORRUPT MEDIA

A legal program command could not be executed because of corrupt media; for example, bad disk or wrong format.

13 CURRENT PARAMETER NOT IN CAL SET

HP-IB only. Correction is not valid for the selected measurement parameter. Refer to Chapter 7.

-222 Data out of range

Numerical parameter of HP-IB command is out of the range defined.

-104 Data type error

Improper data type used (for example, string data was expected, but numeric data was received).

10 DC CALIBRATION ABORTED

Pressing the **ABORT DC CAL** softkey causes the analyzer to abort the DC detector linearity calibration in progress.

97 DC OVERLOAD ON INPUT A

96 DC OVERLOAD ON INPUT B

98 DC OVERLOAD ON INPUT R

The DC voltage at one of the three receiver inputs approaches a DC damage level. Refer to "Instrument Specifications" in the *General Information* section for the DC damage level.

-255 DIRECTORY FULL

A legal program command could not be executed because the media directory was full.

142 DRAM TEST FAILED

Severe error. Contact your nearest Hewlett-Packard office.

144 EEPROM TEST FAILED

Severe error. Contact your nearest Hewlett-Packard office.

182 EEPROM WRITE FAILED

Severe error. Contact your nearest Hewlett-Packard office.

12 EXCEEDED 7 STANDARDS PER CLASS

A maximum of seven standards can be defined for any class. Refer to Chapter 7.

5 EXTERNAL REFERENCE UNLOCKED

The frequency of the external reference signal input to the connector on the rear panel deviates from 10/N MHz, where N is an integer between 1 to 10, and phase lock can no longer be maintained. Refer to Chapter 2 for details about the signal.

158 FAN POWER OUT OF SPEC

Severe error. Contact your nearest Hewlett-Packard office.

153 FDC CHIP TEST FAILED

Severe error. Contact your nearest Hewlett-Packard office.

-257 FILE NAME ERROR

A legal program command could not be executed because the file name on the device media was in error; for example, an attempt was made to copy to a duplicate file name.

-256 FILE NAME NOT FOUND

A legal program command could not be executed because the file name on the device media was not found; for example, an attempt was made to read or copy a nonexistent file.

191 FN FREQ TEST FAILED

Severe error. Contact your nearest Hewlett-Packard office.

181 FN PRETUNE-DAC/MONITOR FAILURE

Severe error. Contact your nearest Hewlett-Packard office.

61 FORMAT NOT VALID FOR MEASUREMENT

The conversion function except the 1/S mode is not valid for the Smith, Inverse Smith, and SWR formats.

32 **FORMAT TYPE IS NOT SMITH**

The conjugate matching function is only valid in the Smith chart format.

147 **FPC TEST FAILED**

Severe error. Contact your nearest Hewlett-Packard office.

-105 **GET not allowed**

GET is not allowed inside a program message.

150 **GSP I/F TEST FAILED**

Severe error. Contact your nearest Hewlett-Packard office.

154 **HPIB CHIP TEST FAILED**

Severe error. Contact your nearest Hewlett-Packard office.

146 **INTR TIMER TEST FAILED**

Severe error. Contact your nearest Hewlett-Packard office.

-161 **Invalid block data**

Invalid block data was received (for example, END received before length satisfied).

-141 **Invalid character data**

Bad character data or unrecognized character data was received.

-121 **Invalid character in number**

Invalid character in numeric data.

-101 **Invalid character**

Invalid character was received.

104 **INVALID FILE NAME**

HP-IB only. The file name for the RECALL, PURGE, or RE-SAVE function must have a extension, "_A", "_D", or "_S". Refer to Chapter 11 for more information.

-103 **Invalid separator**

The message unit separator (for example, ";", ",", ") is improper.

-151 **Invalid string data**

Invalid string data was received (for example, END received before close quote).

-131 Invalid suffix

Units are unrecognized, or the units are not appropriate.

152 KEY CHIP TEST FAILED

Severe error. Contact your nearest Hewlett-Packard office.

66 LIST TABLE EMPTY OR INSUFFICIENT TABLE

The frequency list is empty. To implement list frequency mode, add segments to the list table. Refer to Chapter 5.

80 LOCAL MAX NOT FOUND

The maximum peak whose sharpness is defined by the peak define function cannot be found.

81 LOCAL MIN NOT FOUND

The minimum peak whose sharpness is defined by the peak define function cannot be found.

-250 MASS STORAGE ERROR

A mass storage error occurred. This error message should be used when the device cannot detect the more specific errors described for errors -251 through -259.

-254 MEDIA FULL

A legal program command could not be executed because the media was full; for example, there is no room on the disk.

-258 MEDIA PROTECTED

A legal program command could not be executed because the media was protected; for example, the write-protect tab on a disk was present.

-251 MISSING MASS STORAGE

A legal program command could not be executed because of missing mass storage; for example, attempt to access an external disk drive by using Instrument BASIC.

-252 MISSING MEDIA

A legal program command could not be executed because of a missing media; for example, no disk.

-109 Missing parameter

A command with improper number of parameters received.

178 MIXER LINEARITY POOR

Severe error. Contact your nearest Hewlett-Packard office.

8 NO CALIBRATION CURRENTLY IN PROGRESS

The **RESUME CAL SEQUENCE** softkey is not valid unless a calibration was already in progress. Start a new calibration. Refer to Chapter 7.

111 NO DATA TRACE DISPLAYED

The **SCALE FOR [DATA]** is selected while the data trace is not displayed.

76 NO DATA TRACE

The **MARKER ON [DATA]** is selected while the data trace is not displayed.

105 NO LEGAL FILES ON DISK

There are no files on the disk with extensions, “_A”, “_D”, or “_S”. Refer to Chapter 11 for more information.

82 NO MARKER DELTA - PEAK DEF NOT SET

The **MARKER → PEAK DEF** softkey requires that delta marker mode be turned on, with at least two markers displayed. Refer to Chapter 8.

79 NO MARKER DELTA - RANGE NOT SET

The **SEARCH RNG STORE** softkey requires that delta marker mode be turned on, with at least two markers displayed. Refer to Chapter 8.

78 NO MARKER DELTA - SPAN NOT SET

The **MARKER → SPAN** softkey requires that delta marker mode be turned on, with at least two markers displayed. Refer to Chapter 8.

112 NO MEMORY TRACE DISPLAYED

The **SCALE FOR [MEMORY]** is selected while the memory trace is not displayed.

77 NO MEMORY TRACE

The **MARKER ON [MEMORY]** is selected while the memory trace is not displayed.

117 NO VALID Ach ABS MAG CORRECTION CONSTANTS

Severe error. Contact your nearest Hewlett-Packard office.

118 NO VALID Bch ABS MAG CORRECTION CONSTANTS

Severe error. Contact your nearest Hewlett-Packard office.

122 NO VALID DC FULL SCALE CORRECTION CONSTANTS

Severe error. Contact your nearest Hewlett-Packard office.

125 NO VALID FN PRETUNE CORRECTION CONSTANTS

Severe error. Contact your nearest Hewlett-Packard office.

123 NO VALID HF PWR LIN CORRECTION CONSTANTS

Severe error. Contact your nearest Hewlett-Packard office.

124 NO VALID LF PWR LIN CORRECTION CONSTANTS

Severe error. Contact your nearest Hewlett-Packard office.

30 NO VALID MEMORY TRACE

If a memory trace is to be displayed or otherwise used, a data trace must first be stored to memory. Refer to "DISPLAY KEY" in Chapter 6.

121 NO VALID RATIO A/B CORRECTION CONSTANTS

Severe error. Contact your nearest Hewlett-Packard office.

119 NO VALID RATIO A/R CORRECTION CONSTANTS

Severe error. Contact your nearest Hewlett-Packard office.

120 NO VALID RATIO B/R CORRECTION CONSTANTS

Severe error. Contact your nearest Hewlett-Packard office.

116 NO VALID Rch ABS MAG CORRECTION CONSTANTS

Severe error. Contact your nearest Hewlett-Packard office.

126 NO VALID STEP OSC CORRECTION CONSTANTS

Severe error. Contact your nearest Hewlett-Packard office.

31 NOT AVAILABLE FOR THIS FORMAT

The D&M SCALE [COUPLED] softkey is not valid when the format is either LOG MAG & PHASE, or LOG MAG & DELAY.

41 NOT ENOUGH DATA

HP-IB only. The amount of data sent to the analyzer is less than that expected.

11 NOT VALID FOR PRESENT TEST SET

The calibration requested is inconsistent with the test set present. This message occurs in the following situations:

- A full 2-port calibration is requested with a test set other than an S-parameter test set.
- A one-path 2-port calibration is requested with an S-parameter test set (this procedure is typically used with a transmission/reflection test set).

-128 Numeric data not allowed

Numerical data not allowed for this operation.

-123 Numeric overflow

Numerical data value was too large (exponent magnitude >32k).

94 OVERLOAD ON INPUT A, POWER REDUCED

93 OVERLOAD ON INPUT B, POWER REDUCED

95 OVERLOAD ON INPUT R, POWER REDUCED

When the power level at one of the three receiver inputs exceeds a certain level greater than the maximum input level, the RF output power level is automatically reduced to minimum and the annotation "P↓" appears in the left margin of the display. Refer to "Power Menu" in Chapter 5.

-108 Parameter not allowed

Too many parameters for the command received.

21 PLOT ABORTED

Pressing the **COPY ABORT** softkey causes the analyzer to abort the plot in progress.

25 PLOTTER NOT READY-PINCH WHEELS UP

If user attempts to plot when plotter's pinch wheels are up, this message is displayed.

23 PLOTTER: not on, not connected, wrong address

The plotter does not respond to control. Verify power to the plotter, and check the HP-IB connection between the analyzer and the plotter. Ensure that the plotter address recognized by the analyzer matches the HP-IB address set on the plotter itself. Refer to "**LOCAL** Key" in Chapter 9 for instruction on setting peripheral addresses.

180 POOR PRETUNE TRACKING

Severe error. Contact your nearest Hewlett-Packard office.

185 POWER LINEARITY TEST FAILED

Severe error. Contact your nearest Hewlett-Packard office.

POWER SHUT DOWN (ANALOG SYSTEM)

Severe error. Contact your nearest Hewlett-Packard office.

4 POWER SHUT DOWN (FDD, FRONT PANEL)

Severe error. Contact your nearest Hewlett-Packard office.

20 PRINT ABORTED

Pressing the **COPY ABORT** softkey causes the analyzer to abort the plot in progress.

24 PRINT/PLOT IN PROGRESS, ABORT WITH COPY ABORT

If a print or plot is in progress and a second print or plot is attempted, this message is displayed and the second attempt is ignored. To abort a print or plot in progress, press **COPY ABORT**.

22 PRINTER: not on, not connected, wrong address

The printer does not respond to control. Verify power to the plotter, and check the HP-IB connection between the analyzer and the printer. Ensure that the printer address recognized by the analyzer matches the HP-IB address set on the printer itself. Refer to "**LOCAL** Key" in Chapter 9 for instruction on setting peripheral addresses.

-112 Program mnemonic too long

Program mnemonic is too long (maximum length is 12 characters).

-430 Query DEADLOCKED

Input buffer and output buffer are full; cannot continue.

-400 Query error

Query is improper.

-410 Query INTERRUPTED

Query is followed by DAB or GET before the response was completed.

-440 Query UNTERMINATED after indefinite response

The query which requests arbitrary data response (*IDN? and *OPT? queries) is sent before usual queries in a program message. (for example, **FREQ?;*IDN?** was expected, but ***IDN?;FREQ?** is received.)

-420 Query UNTERMINATED

Addressed to talk, incomplete program message received.

145 RATE TIMER TEST FAILED

Severe error. Contact your nearest Hewlett-Packard office.

163 Rch +5V(D)/2 OUT OF SPEC

Severe error. Contact your nearest Hewlett-Packard office.

172 Rch A/D LINEARITY POOR

Severe error. Contact your nearest Hewlett-Packard office.

164 Rch A/D REF VOLTAGE OUT OF SPEC

Severe error. Contact your nearest Hewlett-Packard office.

169 Rch RECEIVER FUNCTIONALLY POOR

Severe error. Contact your nearest Hewlett-Packard office.

148 REALTIME CLOCK TEST FAILED

Severe error. Contact your nearest Hewlett-Packard office.

REAR PANEL FAN STOPPED

The analyzer detected that the rear panel fan stopped and automatically shut the power down.

103 RECALL ERROR: INSTR STATE PRESET

A serious error, for example corrupted data, is detected on recalling file, and this forced the analyzer to be preset.

184 RF AMP FLATNESS TEST FAILED

Severe error. Contact your nearest Hewlett-Packard office.

187 RF MIXER LOCAL PORT ALC TEST FAILED

Severe error. Contact your nearest Hewlett-Packard office.

193 RF OSC TEST FAILED

Severe error. Contact your nearest Hewlett-Packard office.

189 RF POWER LEVEL ALC(HF) TEST FAILED

Severe error. Contact your nearest Hewlett-Packard office.

188 RF POWER LEVEL ALC(LF) TEST FAILED

Severe error. Contact your nearest Hewlett-Packard office.

102 SAVE ERROR

A serious error, for example physically damaged disk surface, is detected on saving file.

175 SOURCE ATTENUATOR OUT OF SPEC

Severe error. Contact your nearest Hewlett-Packard office.

183 STEP OSC TEST FAILED

Severe error. Contact your nearest Hewlett-Packard office.

-150 String data error

String data is improper.

-158 String data not allowed

String data is not allowed.

-138 Suffix not allowed

A suffix is not allowed for this operation.

-102 Syntax error

Unrecognized command or data type was received.

-124 Too many digits

Numerical data length was too long (more than 255 digits received).

-350 Too many errors

Too many errors occurred in HP-IB commands.

67 TOO MANY SEGMENTS OR POINTS

Frequency list mode is limited to 31 segments or 801 points. Refer to "Edit List Menu" in Chapter 5 for more information.

50 TOO MANY SEGMENTS

The maximum number of segments for the limit line table is 18. Refer to Chapter 9.

-223 Too much data

Either there is too much binary data to send to the analyzer when data transfer format is FORM 2, FORM 3 or FORM 5, or number of data is greater than the number of points.

40 TOO MUCH DATA

The number of data to be sent to the analyzer is greater than that expected.

-113 Undefined header

Undefined header or an unrecognized command was received (operation not allowed).

179 VCO MISADJUSTED,RETRY THIS TEST

Severe error. Contact your nearest Hewlett-Packard office.

151 VRAM TEST FAILED

Severe error. Contact your nearest Hewlett-Packard office.

ERROR MESSAGES IN NUMERICAL ORDER

POWER SHUT DOWN (ANALOG SYSTEM)

Severe error. Contact your nearest Hewlett-Packard office.

A40 HEAT SINK TOO HOT

The temperature sensors on the A4 post-regulator assembly have detected an over-temperature condition. Power off and cool down the instrument for approximately 10 minutes. If this message is displayed again, contact your nearest Hewlett-Packard office.

REAR PANEL FAN STOPPED

The analyzer detected that the rear panel fan stopped and automatically shut the power down.

4 POWER SHUT DOWN (FDD, FRONT PANEL)

Severe error. Contact your nearest Hewlett-Packard office.

5 EXTERNAL REFERENCE UNLOCKED

The frequency of the external reference signal input to the connector on the rear panel deviates from $10/N$ MHz, where N is an integer between 1 to 10, and phase lock can no longer be maintained. Refer to Chapter 2 for details about the signal.

6 ADDITIONAL STANDARDS NEEDED

Error correction for the selected calibration class cannot be computed until all the necessary standards have been measured.

7 CALIBRATION REQUIRED

No valid calibration coefficients were found, when user attempted to turn calibration on. Refer to Chapter 7.

8 NO CALIBRATION CURRENTLY IN PROGRESS

The **RESUME CAL SEQUENCE** softkey is not valid unless a calibration was already in progress. Start a new calibration. Refer to Chapter 7.

9 CALIBRATION ABORTED

The calibration in progress was terminated due to change of the active channel or stimulus parameters.

10 DC CALIBRATION ABORTED

Pressing the **ABORT DC CAL** softkey causes the analyzer to abort the DC detector linearity calibration in progress.

11 NOT VALID FOR PRESENT TEST SET

The calibration requested is inconsistent with the test set present. This message occurs in the following situations:

- A full 2-port calibration is requested with a test set other than an S-parameter test set.
- A one-path 2-port calibration is requested with an S-parameter test set (this procedure is typically used with a transmission/reflection test set).

12 EXCEEDED 7 STANDARDS PER CLASS

A maximum of seven standards can be defined for any class. Refer to Chapter 7.

13 CURRENT PARAMETER NOT IN CAL SET

HP-IB only. Correction is not valid for the selected measurement parameter. Refer to Chapter 7.

14 BACKUP DATA LOST

Data check-sum error on the battery backup memory has occurred. The battery is recharged for approximately 10 minutes after power on.

20 PRINT ABORTED

Pressing the **COPY ABORT** softkey causes the analyzer to abort the plot in progress.

21 PLOT ABORTED

Pressing the **COPY ABORT** softkey causes the analyzer to abort the plot in progress.

22 PRINTER: not on, not connect, wrong address

The printer does not respond to control. Verify power to the plotter, and check the HP-IB connection between the analyzer and the printer. Ensure that the printer address recognized by the analyzer matches the HP-IB address set on the printer itself. Refer to "**LOCAL** Key" in Chapter 9 for instruction on setting peripheral addresses.

23 PLOTTER: not on, not connect, wrong address

The plotter does not respond to control. Verify power to the plotter, and check the HP-IB connection between the analyzer and the plotter. Ensure that the plotter address recognized by the analyzer matches the HP-IB address set on the plotter itself. Refer to “**LOCAL** Key” in Chapter 9 for instruction on setting peripheral addresses.

24 PRINT/PLOT IN PROGRESS, ABORT WITH COPY ABORT

If a print or plot is in progress and a second print or plot is attempted, this message is displayed and the second attempt is ignored. To abort a print or plot in progress, press **COPY ABORT**.

25 PLOTTER NOT READY-PINCH WHEELS UP

If user attempts to plot when plotter’s pinch wheels are up, this message is displayed.

30 NO VALID MEMORY TRACE

If a memory trace is to be displayed or otherwise used, a data trace must first be stored to memory. Refer to “**DISPLAY** KEY” in Chapter 6.

31 NOT AVAILABLE FOR THIS FORMAT

The **D&M SCALE [COUPLED]** softkey is not valid when the format is either LOG MAG & PHASE, or LOG MAG & DELAY.

32 FORMAT TYPE IS NOT SMITH

The conjugate matching function is only valid in the Smith chart format.

40 TOO MUCH DATA

The number of data to be sent to the analyzer is greater than that expected.

41 NOT ENOUGH DATA

HP-IB only. The amount of data sent to the analyzer is less than that expected.

50 TOO MANY SEGMENTS

The maximum number of segments for the limit line table is 18. Refer to Chapter 9.

60 CAN’T CHANGE- ANOTHER CONTROLLER ON BUS

The analyzer cannot assume the mode of system controller until the active controller is removed from the bus or relinquishes the bus.

61 FORMAT NOT VALID FOR MEASUREMENT

The conversion function except the 1/S mode is not valid for the Smith, Inverse Smith, and SWR formats.

66 LIST TABLE EMPTY OR INSUFFICIENT TABLE

The frequency list is empty. To implement list frequency mode, add segments to the list table. Refer to Chapter 5.

67 TOO MANY SEGMENTS OR POINTS

Frequency list mode is limited to 31 segments or 801 points. Refer to “Edit List Menu” in Chapter 5 for more information.

76 NO DATA TRACE

The **MARKER ON [DATA]** is selected while the data trace is not displayed.

77 NO MEMORY TRACE

The **MARKER ON [MEMORY]** is selected while the memory trace is not displayed.

78 NO MARKER DELTA - SPAN NOT SET

The **MARKER → SPAN** softkey requires that delta marker mode be turned on, with at least two markers displayed. Refer to Chapter 8.

79 NO MARKER DELTA - RANGE NOT SET

The **SEARCH RNG STORE** softkey requires that delta marker mode be turned on, with at least two markers displayed. Refer to Chapter 8.

80 LOCAL MAX NOT FOUND

The maximum peak whose sharpness is defined by the peak define function cannot be found.

81 LOCAL MIN NOT FOUND

The minimum peak whose sharpness is defined by the peak define function cannot be found.

82 NO MARKER DELTA - PEAK DEF NOT SET

The **MARKER → PEAK DEF** softkey requires that delta marker mode be turned on, with at least two markers displayed. Refer to Chapter 8.

93 OVERLOAD ON INPUT B, POWER REDUCED

94 OVERLOAD ON INPUT A, POWER REDUCED

95 OVERLOAD ON INPUT R, POWER REDUCED

When the power level at one of the three receiver inputs exceeds a certain level greater than the maximum input level, the RF output power level is automatically reduced to minimum and the annotation “P↓” appears in the left margin of the display. Refer to “Power Menu” in Chapter 5.

96 DC OVERLOAD ON INPUT B

97 DC OVERLOAD ON INPUT A

98 DC OVERLOAD ON INPUT R

The DC voltage at one of the three receiver inputs approaches a DC damage level. Refer to "Instrument Specifications" in the *General Information* section for the DC damage level.

102 SAVE ERROR

A serious error, for example physically damaged disk surface, is detected on saving file.

103 RECALL ERROR: INSTR STATE PRESET

A serious error, for example corrupted data, is detected on recalling file, and this forced the analyzer to be preset.

104 INVALID FILE NAME

HP-IB only. The file name for the RECALL, PURGE, or RE-SAVE function must have an extension, "_A", "_D", or "_S". Refer to Chapter 11 for more information.

105 NO LEGAL FILES ON DISK

There are no files on the disk with extensions, "_A", "_D", or "_S". Refer to Chapter 11 for more information.

111 NO DATA TRACE DISPLAYED

The **SCALE FOR [DATA]** is selected while the data trace is not displayed.

112 NO MEMORY TRACE DISPLAYED

The **SCALE FOR [MEMORY]** is selected while the memory trace is not displayed.

116 NO VALID Rch ABS MAG CORRECTION CONSTANTS

Severe error. Contact your nearest Hewlett-Packard office.

117 NO VALID Ach ABS MAG CORRECTION CONSTANTS

Severe error. Contact your nearest Hewlett-Packard office.

118 NO VALID Bch ABS MAG CORRECTION CONSTANTS

Severe error. Contact your nearest Hewlett-Packard office.

119 NO VALID RATIO A/R CORRECTION CONSTANTS

Severe error. Contact your nearest Hewlett-Packard office.

120 NO VALID RATIO B/R CORRECTION CONSTANTS

Severe error. Contact your nearest Hewlett-Packard office.

121 NO VALID RATIO A/B CORRECTION CONSTANTS

Severe error. Contact your nearest Hewlett-Packard office.

122 NO VALID DC FULL SCALE CORRECTION CONSTANTS

Severe error. Contact your nearest Hewlett-Packard office.

123 NO VALID HF PWR LIN CORRECTION CONSTANTS

Severe error. Contact your nearest Hewlett-Packard office.

124 NO VALID LF PWR LIN CORRECTION CONSTANTS

Severe error. Contact your nearest Hewlett-Packard office.

125 NO VALID FN PRETUNE CORRECTION CONSTANTS

Severe error. Contact your nearest Hewlett-Packard office.

126 NO VALID STEP OSC CORRECTION CONSTANTS

Severe error. Contact your nearest Hewlett-Packard office.

136 CONTINUOUS SWITCHING NOT ALLOWED

The current measurement requires the S-parameter test set to switch automatically between forward and reverse measurements (driving test port 1 and, then test port 2). Refer to Chapter 5.

141 A1 ROM TEST FAILED

Severe error. Contact your nearest Hewlett-Packard office.

142 DRAM TEST FAILED

Severe error. Contact your nearest Hewlett-Packard office.

143 BACKUP RAM TEST FAILED

Severe error. Contact your nearest Hewlett-Packard office.

144 EEPROM TEST FAILED

Severe error. Contact your nearest Hewlett-Packard office.

145 RATE TIMER TEST FAILED

Severe error. Contact your nearest Hewlett-Packard office.

146 INTR TIMER TEST FAILED

Severe error. Contact your nearest Hewlett-Packard office.

147 FPC TEST FAILED

Severe error. Contact your nearest Hewlett-Packard office.

148 REALTIME CLOCK TEST FAILED

Severe error. Contact your nearest Hewlett-Packard office.

149 A1 CPU EXT BUS TEST FAILED

Severe error. Contact your nearest Hewlett-Packard office.

150 GSP I/F TEST FAILED

Severe error. Contact your nearest Hewlett-Packard office.

151 VRAM TEST FAILED

Severe error. Contact your nearest Hewlett-Packard office.

152 KEY CHIP TEST FAILED

Severe error. Contact your nearest Hewlett-Packard office.

153 FDC CHIP TEST FAILED

Severe error. Contact your nearest Hewlett-Packard office.

154 HPIB CHIP TEST FAILED

Severe error. Contact your nearest Hewlett-Packard office.

155 -15V OUT OF SPEC

Severe error. Contact your nearest Hewlett-Packard office.

156 -12.6V OUT OF SPEC

Severe error. Contact your nearest Hewlett-Packard office.

157 +18V OUT OF SPEC

Severe error. Contact your nearest Hewlett-Packard office.

158 FAN POWER OUT OF SPEC

Severe error. Contact your nearest Hewlett-Packard office.

159 **+12V OUT OF SPEC**

Severe error. Contact your nearest Hewlett-Packard office.

160 **+15V(A) OUT OF SPEC**

Severe error. Contact your nearest Hewlett-Packard office.

161 **+22V OUT OF SPEC**

Severe error. Contact your nearest Hewlett-Packard office.

162 **+65V OUT OF SPEC**

Severe error. Contact your nearest Hewlett-Packard office.

163 **Rch +5V(D)/2 OUT OF SPEC**

Severe error. Contact your nearest Hewlett-Packard office.

164 **Rch A/D REF VOLTAGE OUT OF SPEC**

Severe error. Contact your nearest Hewlett-Packard office.

165 **Ach +5V(A)/2 OUT OF SPEC**

Severe error. Contact your nearest Hewlett-Packard office.

166 **Ach A/D REF VOLTAGE OUT OF SPEC**

Severe error. Contact your nearest Hewlett-Packard office.

167 **Bch -5.2V(A)/2 OUT OF SPEC**

Severe error. Contact your nearest Hewlett-Packard office.

168 **Bch A/D REF VOLTAGE OUT OF SPEC**

Severe error. Contact your nearest Hewlett-Packard office.

169 **Rch RECEIVER FUNCTIONALLY POOR**

Severe error. Contact your nearest Hewlett-Packard office.

170 **Ach RECEIVER FUNCTIONALLY POOR**

Severe error. Contact your nearest Hewlett-Packard office.

171 **Bch RECEIVER FUNCTIONALLY POOR**

Severe error. Contact your nearest Hewlett-Packard office.

172 Rch A/D LINEARITY POOR

Severe error. Contact your nearest Hewlett-Packard office.

173 Ach A/D LINEARITY POOR

Severe error. Contact your nearest Hewlett-Packard office.

174 Bch A/D LINEARITY POOR

Severe error. Contact your nearest Hewlett-Packard office.

175 SOURCE ATTENUATOR OUT OF SPEC

Severe error. Contact your nearest Hewlett-Packard office.

176 Ach/Rch IF GAIN OUT OF SPEC

Severe error. Contact your nearest Hewlett-Packard office.

177 Bch/Rch IF GAIN OUT OF SPEC

Severe error. Contact your nearest Hewlett-Packard office.

178 MIXER LINEARITY POOR

Severe error. Contact your nearest Hewlett-Packard office.

179 VCO MISADJUSTED,RETRY THIS TEST

Severe error. Contact your nearest Hewlett-Packard office.

180 POOR PRETUNE TRACKING

Severe error. Contact your nearest Hewlett-Packard office.

181 FN PRETUNE-DAC/MONITOR FAILURE

Severe error. Contact your nearest Hewlett-Packard office.

182 EEPROM WRITE FAILED

Severe error. Contact your nearest Hewlett-Packard office.

183 STEP OSC TEST FAILED

Severe error. Contact your nearest Hewlett-Packard office.

184 RF AMP FLATNESS TEST FAILED

Severe error. Contact your nearest Hewlett-Packard office.

185 POWER LINEARITY TEST FAILED

Severe error. Contact your nearest Hewlett-Packard office.

186 1st LOCAL MIXER LOCAL PORT ALC TEST FAILED

Severe error. Contact your nearest Hewlett-Packard office.

187 RF MIXER LOCAL PORT ALC TEST FAILED

Severe error. Contact your nearest Hewlett-Packard office.

188 RF POWER LEVEL ALC(LF) TEST FAILED

Severe error. Contact your nearest Hewlett-Packard office.

189 RF POWER LEVEL ALC(HF) TEST FAILED

Severe error. Contact your nearest Hewlett-Packard office.

190 1st LOCAL AMP TEST FAILED

Severe error. Contact your nearest Hewlett-Packard office.

191 FN FREQ TEST FAILED

Severe error. Contact your nearest Hewlett-Packard office.

192 1st IF OFFSET OSC TEST FAILED

Severe error. Contact your nearest Hewlett-Packard office.

193 RF OSC TEST FAILED

Severe error. Contact your nearest Hewlett-Packard office.

-440 Query UNTERMINATED after indefinite response

The query which requests arbitrary data response (*IDN? and *OPT? queries) is sent before usual queries in a program message. (for example, FREQ?;*IDN? was expected, but *IDN?;FREQ? is received.)

-430 Query DEADLOCKED

Input buffer and output buffer are full; cannot continue.

-420 Query UNTERMINATED

Addressed to talk, incomplete program message received.

-410 Query INTERRUPTED

Query is followed by DAB or GET before the response was completed.

–400 **Query error**

Query is improper.

–350 **Too many errors**

Too many errors occurred in HP-IB commands.

–258 **MEDIA PROTECTED**

A legal program command could not be executed because the media was protected; for example, the write-protect tab on a disk was present.

–257 **FILE NAME ERROR**

A legal program command could not be executed because the file name on the device media was in error; for example, an attempt was made to copy to a duplicate file name.

–256 **FILE NAME NOT FOUND**

A legal program command could not be executed because the file name on the device media was not found; for example, an attempt was made to read or copy a nonexistent file.

–255 **DIRECTORY FULL**

A legal program command could not be executed because the media directory was full.

–254 **MEDIA FULL**

A legal program command could not be executed because the media was full; for example, there is no room on the disk.

–253 **CORRUPT MEDIA**

A legal program command could not be executed because of corrupt media; for example, bad disk or wrong format.

–252 **MISSING MEDIA**

A legal program command could not be executed because of a missing media; for example, no disk.

–251 **MISSING MASS STORAGE**

A legal program command could not be executed because of missing mass storage; for example, attempt to access an external disk drive by using Instrument BASIC.

–250 **MASS STORAGE ERROR**

A mass storage error occurred. This error message should be used when the device cannot detect the more specific errors described for errors –251 through –259.

-223 Too much data

Either there is too much binary data to send to the analyzer when data transfer format is FORM 2, FORM 3 or FORM 5, or number of data is greater than the number of points.

-222 Data out of range

Numerical parameter of HP-IB command is out of the range defined.

-168 Block data not allowed

Block data is not allowed.

-161 Invalid block data

Invalid block data was received (for example, END received before length satisfied).

-160 Block data error

Block data is improper.

-158 String data not allowed

String data is not allowed.

-151 Invalid string data

Invalid string data was received (for example, END received before close quote).

-150 String data error

String data is improper.

-148 Character data not allowed

Character data not allowed for this operation.

-144 Character data too long

Character data is too long (maximum length is 12 characters).

-141 Invalid character data

Bad character data or unrecognized character data was received.

-138 Suffix not allowed

A suffix is not allowed for this operation.

-131 Invalid suffix

Units are unrecognized, or the units are not appropriate.

-128 Numeric data not allowed

Numerical data not allowed for this operation.

-124 Too many digits

Numerical data length was too long (more than 255 digits received).

-123 Numeric overflow

Numerical data value was too large (exponent magnitude >32k).

-121 Invalid character in number

Invalid character in numeric data.

-113 Undefined header

Undefined header or an unrecognized command was received (operation not allowed).

-112 Program mnemonic too long

Program mnemonic is too long (maximum length is 12 characters).

-109 Missing parameter

A command with improper number of parameters received.

-108 Parameter not allowed

Too many parameters for the command received.

-105 GET not allowed

GET is not allowed inside a program message.

-104 Data type error

Improper data type used (for example, string data was expected, but numeric data was received).

-103 Invalid separator

The message unit separator (for example, ";", ",", ") is improper.

-102 Syntax error

Unrecognized command or data type was received.

-101 Invalid character

Invalid character was received.

Index

Symbols

x1, 4-2
⇓, 4-2
⇑, 4-2
↑, 5-9
*, 2-8, 5-10
Δ MODE MENU, 8-4
Δ MODE OFF, 8-7
Δ REF MARKER, 8-7
ΔREF=Δ FIXED MKR, 8-7

Numbers

1/S, 6-8

A

A, 6-6
AB, 6-6
A/B, 6-6
ABODCALI, 7-17
ABORT DC CAL, 7-17
ACTIVATE MARKER, 8-4
Active channel, 2-6, 3-1
Active channel key, 2-4, 3-1
Active Entry Area, 2-8
Active marker, 8-4, 8-5
ADD, 5-14, 9-18
ADDRCONT, 9-6
ADDRESS: 8751, 9-6
Addressable, 9-4, 12-4
ADDRESSABLE ONLY, 9-4
ADDRESS: CONTROLLER, 9-6
ADDRESS: PLOTTER, 9-6
ADDRESS: PRINTER, 9-6
ADDRPLOT, 9-6
ADDRPRIN, 9-6
ADJUST DISPLAY, 6-26
Adjust display menu, 6-33
ADR, 2-8
ALC (automatic leveling control), 1-2
ALL BASIC, 6-27
ALL INSTRUMENT, 6-27

ALL MKR OFF, 8-4
AMPLITUDE OFFSET, 9-21
Aperture, 6-17
AR, 6-6
A/R, 6-6
ATTEN, 6-2, 6-42
Attenuator menu, 6-42
ATTENUATOR PORT 1, 5-8
ATTENUATOR PORT 2, 5-8
ATTIA0DB, 6-42
ATTIA20DB, 6-42
ATTIB0DB, 6-42
ATTIB20DB, 6-42
ATTIRODB, 6-42
ATTIR20DB, 6-42
ATTP1, 5-8
ATTP2, 5-8
AUTO, 6-20
AUTOREC, 11-3
Auto recall, 11-3
AUTO SCALE, 6-20
Auto sweep time, 5-9
Averaging, 1-6, 6-37
Averaging factor, 6-37, 6-40
AVERAGING FACTOR, 6-39
AVERAGING on OFF, 6-40
AVERAGING RESTART, 6-39, 6-40
AVERFACT, 6-39
AVEROFF, 6-40
AVERON, 6-40
AVERREST, 6-39
Avg, 2-8, 6-40
AVG, 6-2, 6-18, 6-37

B

B, 6-6
BACI, 6-33
BACKGROUND INTENSITY, 6-33
BACK SPACE, 4-2
BACK SPACE, 6-29, 11-10
BASIC STATUS, 6-27
Battery backup, A-1

BDC, 6-5
Bdc, 6-5
BDCR, 6-5
Bdc/R, 6-5
BEEP DONE OFF, 6-26
BEEP DONE ON, 6-26
BEEP DONE ON off, 6-26
BEEP FAIL OFF, 9-17
BEEP FAIL ON, 9-17
BEEP FAIL on OFF, 9-17
BEEP WARN OFF, 6-26
BEEP WARN ON, 6-26
BEEP WARN on OFF, 6-26
BLUE connector, 2-10
BR, 6-6
E/R, 6-6
BRIGHTNESS, 6-35, 6-36
Built-in Flexible Disk Drive, 2-5

C

C1, 2-8
C?, 2-8
C2, 2-8
C2!, 2-8
C2?, 2-8
CAL, 7-8
CAL ARY on OFF, 11-11
CALCASSI, 10-13
CALCULATE PARAMETERS, 6-31, 6-32
CALIBRATE MENU, 7-12
CALIBRATE: NONE, 7-18
Calibration, 7-1, 7-17
Calibration coefficients arrays, 11-1
Calibration kit, 7-34
Calibration standard, 1-2
CALIFUL2, 7-19
CALIONE2, 7-19
CALIRAI, 7-18
CALIRESP, 7-18
CALIS111, 7-18
CALIS221, 7-19
CALK7MM, 7-13
Cal kit, 7-34
CAL KIT: 7 mm, 7-13
CAL KIT, 7-12, 7-35
CAL KIT DEFINITION, 10-13
CALKN50, 7-13
CALKN75, 7-13
CALKUSED, 7-13
CALN, 7-18
CALP, 6-31

CALS, 10-14
CBRI, 6-35
CENT, 5-3, 5-16
CENTER, 5-16
CH1, 3-1
CH1 DATA, 6-34
CH1 MEM LIMIT LN, 6-34
CH2, 3-1
CH2 DATA, 6-34
CH2 MEM LIMIT LN, 6-34
CHAN1, 3-1
CHAN2, 3-1
Channel coupling, 7-9
Class assignment, A-8
CLASS ASSIGNMENT, 10-13
CLEAR LIST, 5-14
Clear list menu, 5-17, 9-20
CLEAR LIST YES, 5-17, 9-20
CLEAR MARKER, 8-4
Clear marker menu, 8-6
CLEAR POWER TRIP, 5-7
CLEL, 5-14, 5-17
CLEM1, 8-6
CLEM2, 8-6
CLEM3, 8-6
CLEM4, 8-6
CLEM5, 8-6
CLEM6, 8-6
CLEM7, 8-6
CLEM8, 8-6
CLEPTRIP, 5-7
Clock menu, 9-8
Cnj, 2-8
CNJ.P DISP on OFF, 6-25
COLOCH1D, 6-34
COLOCH1M, 6-34
COLOCH2D, 6-34
COLOCH2M, 6-34
COLOGRAT, 6-34
COLOR, 6-35
COLOR, 6-35, 6-36, 10-5
Color adjust menu, 6-35
COLOTEXT, 6-34
COLOWARN, 6-34
CONJ MATCH on OFF, 6-31
Conjugate matching, 1-7, 6-30
CONJUGATE MATCHING, 6-25
Conjugate matching circuit parameters, 2-8
CONMOFF, 6-31
COMMON, 6-31
CONPCP, 6-31

CONPCS, 6-31
 CONPDISPOFF, 6-25
 CONPDISPON, 6-25
 CONPLP, 6-31
 CONPLS, 6-31
 CONT, 5-10
 CONTINUOUS, 5-10, 8-10
 Controller, 12-2
 CONV, 6-5
 CONV1DS, 6-8
 CONVERSION, 6-5, 6-6
 Conversion menu, 6-7
 CONVOFF, 6-8
 CONVYREF, 6-8
 CONVYTRA, 6-8
 CONVZREF, 6-8
 CONVZTRA, 6-8
 COPA, 10-5, 10-16
 COPTOFF, 10-5, 10-16
 COPTON, 10-5, 10-16
 COPY, 9-8, 10-2
 COPY ABORT, 10-5, 10-16
 Copy cal kit menu, 10-13
 Copy limit test menu, 10-15
 Copy list sweep menu, 10-14
 Copy menu, 10-4
 Copy more menu, 10-11
 Copy standard number menu, 10-14
 COPY TIME, 9-8
 COPY TIME on OFF, 10-5, 10-16
 Cor, 2-8
 Correction menu, 7-11
 CORRECTION on OFF, 7-11
 CORROFF, 7-11
 CORRON, 7-11
 COUCOFF, 5-6
 COUCON, 5-6
 COUPLED CH on OFF, 5-6
 Cp, 6-31
 Cp-Cs, 6-32
 Cp-Ls, 6-32
 Crosstalk, 7-2, 7-5, 7-18
 CRT display, 2-4, 2-6
 Cs, 6-31
 Cs-Cp, 6-32
 Cs-Lp, 6-32
 CTR & SPAN, 10-15
 CWFREQ, 5-7
 CW FREQ, 5-7

D

DATA and MEMORY, 6-28
 Data arrays, 11-2
 DATA ARY on OFF, 11-11
 DATA & GRATCL, 10-8
 DATA-MEM, 6-28
 DATA/MEM, 6-28
 DATA ONLY, 10-8
 Data point, 1-4
 DATA — MEM, 6-28
 DATE MM/DD/YY, 9-8
 DATE MODE: MonDayYear, 9-9
 DATI, 6-28
 DAY, 9-10
 DayMonYear, 9-9
 DAYMYEAR, 9-9
 DCCOROFF, 7-16
 DCCORON, 7-16
 DC correction menu, 7-16
 DC CORR on OFF, 7-16
 DC DETECT. LIN CORR, 7-15
 DC voltage measurement, 6-4
 Default, A-1
 DEFAULT COLORS, 6-33, 6-36
 DEFAULT SETUP, 10-6
 DEFC, 6-33
 DEFINE PLOT, 10-5
 Define plot menu, 10-8
 DEFINE SAVE DATA, 11-9
 Define save data menu, 11-11
 DEFINE STANDARD, 7-36
 Define standard menu, 7-37
 Define standard number menu, 7-37
 DEFINE TRACE, 6-25
 DEFS, 7-36
 Del, 2-8
 DELA, 6-10
 DELAY, 6-10
 DELETE, 5-14, 9-18
 DELO, 8-7
 DELR1, 8-8
 DELR2, 8-8
 DELR3, 8-8
 DELR4, 8-8
 DELR5, 8-8
 DELR6, 8-8
 DELR7, 8-8
 DELR8, 8-8
 DELRFIXM, 8-7

DELTA LIMITS , 9-19
Delta marker menu, 8-8
Delta marker mode, 8-2, 8-7
DFLT, 10-6
Directivity, 7-2, 7-18, 7-19, 7-47
DISAALLB, 6-27
DISAALLI, 6-27
DISAHHB, 6-27
Disk capacity, 11-3
Disk format, 11-3
Disk menu, 11-13
DISL1, 10-14
DISL2, 10-14
DISLLIST, 10-15
DISMCTSP, 10-15
DISMMD, 10-15
DISMNUM, 10-15
DISMSTEP, 10-15
DISMSTSP, 10-15
DISMUL, 10-15
DISPDATA, 6-28
DISPDATM, 6-28
DISPDDM, 6-28
DISPDMM, 6-28
DISPLAY, 6-1, 6-23
DISPLAY ALLOCATION, 6-25
Display allocation menu, 6-27
DISPLAY: DATA, 6-28
DISPLAY LIST, 10-15
DISPLAY: LIST1, 10-14
Display menu, 6-24
DISPMEMO, 6-28
DISP MODE: ST & SP, 10-15
DISP MODE: UPR & LWR, 10-15
D&M SCALE, 6-20
DUACOFF, 6-24
DUACON, 6-24
DUAL CHAN on OFF, 6-24
DUT, 1-1

E

EDIT: , 5-14
EDIT, 5-14, 9-18
EDITDONE, 5-14
EDIT LIMIT LINE, 9-17
Edit limits menu, 9-17
EDITLIML, 9-17
EDITLIS1, 5-14
EDITLIS2, 5-14
EDITLIST, 5-12
EDIT LIST, 5-12
Edit list menu, 5-13

Edit segment menu, 5-14, 9-18
ELEC DELAY MENU, 6-20
Electrical delay, 1-7, 6-20, 7-16
ELECTRICAL DELAY, 6-21, 7-14
ELED, 6-21
Entry, 2-5, 4-1
ENTRY OFF, 4-2
ERASE TITLE, 6-29, 11-10
EXECUTE DC CAL, 7-16
EXEDCALI, 7-16
EXPANDED PHASE, 6-13
Expanded Phase format, 6-14
EXPP, 6-13
Ext, 2-8
EXTENSION, 7-15
EXTENSIONS on OFF, 7-15
EXT PROG RUN/CONT connector, 2-10
EXT REF INPUT connector, 2-10
EXTTOFF, 5-10
EXTTON, 5-10
EXTTPOIN, 5-11
EXT TRIGGER connector, 2-10
EXT. TRIG ON POINT, 5-11
EXT. TRIG ON SWEEP, 5-10

F

Factory setting, A-1
Fan, 2-10
File name, 11-2
File size, 11-3
FILE UTILITIES, 11-8, 11-17
Fixed marker menu, 8-9
FIXED MKR AUX VALUE, 8-10
FIXED MKR STIMULUS, 8-9
FIXED MKR VALUE, 8-10
Format, 2-6, 6-9
FORMAT, 6-1, 6-9
Format more menu, 6-13
Forward transmission coefficient, 6-5
FREQ, 6-26
FREQUENCY BLANK, 6-26
Frequency list mode, 5-12
Frequency response, 7-2, 7-6, 7-18, 7-19, 7-47, 7-49, 7-52
Front panel, 2-4
FULL 2-PORT, 7-19
Full 2-Port Calibration, 7-27
FULL PAGE, 10-7
Full two-port calibration, 7-6
FULP, 10-7

FWD MATCH, 7-44
FWD TRANS. , 7-44

G

G, 4-2
G/n, 4-2
GRATICULE, 6-34
GREEN connector, 2-10
GRODAPER, 6-40
Group delay, 6-16
GROUP DELAY APERTURE, 6-18, 6-40

H

HALF INSTR HALF BASIC, 6-27
Hard copy, 10-1
Hewlett-Packard Interface Bus, 9-3, 12-1
Hld, 2-8, 5-10
HOLD, 5-10
HOLD , 5-10
HOUR , 9-9
HP 11667A, 1-2
HP 11850C/D, 1-2
HP 87511A/B, 1-2, 2-9, 7-54
HP 87512A/B, 1-2, 2-9, 6-4, 7-54
HP-HIL connector, 2-5
HP-IB, 2-3, 9-3, 12-1
HP-IB address, 12-4
HP-IB connector, 2-9

I

IBASIC, 9-7
IF bandwidth, 1-6, 6-38, 6-40, 6-41
IFBW, 5-16, 6-40
IF BW , 5-16, 6-40
IFBWAUTO, 6-41
IF BW AUTO, 6-41
IF (Intermediate frequency), 1-2
IMAG, 6-13
IMAGINARY, 6-13
Imaginary format, 6-13
INID, 11-13
Initialize, A-1
INITIALIZE DISK, 11-13
Initialize menu, 11-16
INITIALIZE YES, 11-16
INPUT-A: , 6-42
INPUT-B: , 6-42
Input port menu, 6-6
INPUT PORTS, 6-5
INPUT-R: , 6-42
Instrument BASIC, 9-21

Instrument data arrays, 11-1
Instrument state, 2-2
Instrument state data, 11-1
Instrument state function, 2-5, 9-1
Instrument states and internal data arrays, 11-2
INTE, 6-33
INTENSITY, 6-33
Interpolated error correction, 5-11, 7-9
INT REF OUTPUT connector, 2-10
Inverse smith chart format, 6-14
InvL TYPE: Cs-Cp , 6-32
InvL TYPE: Cs-Lp , 6-32
InvL TYPE: Ls-Cp , 6-32
InvL TYPE: Ls-Lp , 6-32
INVSCHAR, 6-14
INV SMITH CHART, 6-14
I/O port connector, 2-9
Isolation, 7-2, 7-5, 7-18, 7-19, 7-52
Isolation calibration, 7-10
Isolation error, 7-53

K

K, 4-2
KEY 15, 7-8
KEY 17, 8-14
KEY 19, 5-5
KEY 24, 4-2
KEY 25, 4-2
KEY 26, 4-2
KEY 27, 4-2
KEY 41, 4-2
KEY 42, 4-2
KEY 43, 4-2
KITD, 7-36
KIT DONE, 7-36
k/m, 4-2

L

LABEL CLASS, 7-36
Label class menu, 7-45
LABEL KIT, 7-36, 7-45
Label kit menu, 7-45
Label standard menu, 7-42
LABK, 7-36
LEFL, 10-7
LEFT LOWER, 10-7
LEFT UPPER, 10-7
LEFU, 10-7
LIF (logical inter change format), 11-3
LIMCLEL, 9-20
LIMD, 9-19
LIMIAMPO, 9-21

LIMILINEOFF, 9-16
 LIMILINEON, 9-16
 LIMIMAOFF, 9-21
 LIMISTIO, 9-21
 LIMITESTOFF, 9-16
 LIMITESTON, 9-16
 Limit line, 9-11
 LIMIT LINE OFFSETS, 9-17
 LIMIT LINE on OFF, 9-16
 LIMIT MENU, 9-7
 Limits menu, 9-16
 Limit test, 9-11
 LIMIT TEST on OFF, 9-16
 LIMIT TEST TABLE, 10-13
 LIML, 9-19
 LIMM, 9-20
 LIMS, 9-19
 LIMSADD, 9-18
 LIMSDEL, 9-18
 LIMSDON, 9-20
 LIMSEDI, 9-18
 LIMU, 9-19
 Linear frequency sweep mode, 5-11
 LINE switch, 2-4
 LINE TYPE DATA, 10-8
 LINE TYPE MEMORY, 10-8
 LINFREQ, 5-11
 LIN FREQ, 5-11
 LINM, 6-12
 LIN MAG, 6-12
 LINTDATA, 10-8
 LINTMEMO, 10-8
 LISDFBASE, 5-12
 LISDOBASE, 5-12
 LISFREQ, 5-12
 LISSLIS1, 5-13
 LISSLIS2, 5-13
 LIST2, 10-14
 LIST DISP: FREQ BASE, 5-12
 LIST DONE, 5-14
 Listener, 12-2
 LIST FREQ [], 5-12
 List sweep menu, 5-12
 LIST SWEEP TABLE, 5-12, 10-13
 LIST VALUES, 10-11
 LISV, 10-11
 Load match, 7-2, 7-4, 7-19, 7-52
 Load match error, 7-53
 LOCAL, 9-3
 LOCAL MAX, 8-19, 8-20
 LOCAL MIN, 8-19, 8-20
 Local mode, 9-3
 Logarithmic frequency sweep mode, 5-11
 LOGFREQ, 5-11
 LOG FREQ, 5-11
 LOGM, 6-9
 LOG MAG, 6-9
 LOG MAG & DELAY, 6-15
 Log magnitude and delay format, 6-15
 Log magnitude and Phase Format, 6-15
 LOG MAG & PHASE, 6-14
 LOGMD, 6-15
 LOGMP, 6-14
 LOWER GRATICULE, 10-9
 LOWER LIMIT, 9-19
 Lp, 6-31
 Lp-Cs, 6-32
 Ls-Cp, 6-32
 L TYPE: Cp-Cs, 6-32
 L TYPE: Cp-Ls, 6-32
 L TYPE: Lp-Cs, 6-32
 L TYPE: Lp-Ls, 6-32
M
 M, 4-2
 MA, 4-2
 man, 5-11
 MANTRIG, 5-11
 Manual Changes, D-1
 Manual sweep time, 5-8
 MANUAL TRG ON POINT, 5-11
 MARK1, 8-5
 MARK2, 8-5
 MARK3, 8-5
 MARK4, 8-5
 MARK5, 8-5
 MARK6, 8-5
 MARK7, 8-5
 MARK8, 8-5
 MARKCENT, 8-15
 MARKCONT, 8-10
 MARKCOUP, 8-11
 MARKDELA, 6-21
 MARKDISC, 8-10
 Marker data readout, 2-7
 Marker function menu, 8-15
 Marker list, 8-1
 Marker menu, 8-4
 Marker mode menu, 8-10
 MARKER MODE MENU, 8-5

MARKER → AMP. OFS. , 9-21
MARKER → CENTER , 8-15
MARKER → DELAY , 6-21
MARKER → DELAY , 6-21
MARKER → MIDDLE , 9-20
MARKER → REFERENCE , 6-20, 8-15
MARKER → SPAN , 8-15
MARKER → START , 8-15
MARKER → STIMULUS , 9-19
MARKER → STOP , 8-15
MARKERS: COUPLED , 8-11
MARKERS: DISCRETE , 8-10
Marker Search menu, 8-17
MARKERS ON [DATA] , 8-4
Marker statistics, width value, 2-7
MARKERS: UNCOUPLED , 6-25
Marker time mode, 8-1
MARKFAUV, 8-10
MARKFSTI, 8-9
MARKFVAL, 8-10
MARKLOFF, 8-4
MARKLON, 8-4
MARKMIDD, 9-20
MARKODATA, 8-4
MARKOFF, 8-4
MARKOMEMO, 8-4
MARKPEAD, 8-19
MARKREF, 6-20, 8-15
MARKSPAN, 8-15
MARKSTAR, 5-15, 8-15
MARKSTIM, 9-19
MARKSTOP, 5-15, 8-15
MARKTIMEOFF, 8-11
MARKTIMEON, 8-11
MARKUNCO, 8-11
MARKZERO, 8-4
MAX , 8-17
(MEAS) , 6-1, 6-2
MEASA, 6-6
MEASB, 6-6
MEASTATOFF, 8-16
MEASTATON, 8-16
Measured input, 2-6
MEASURE RESTART , 5-2, 5-6
MEMORY , 6-28
Memory arrays, 11-2
MEMORY ARY on OFF , 11-11
Memory trace arrays, 11-2
(MENU) , 5-5

Message area, 2-8
MIDDLE VALUE , 9-20
MID & DLT , 10-15
MIN , 8-17, 9-9
Minimum sweep time, 5-9
(MKR) , 8-1
(MKR FCTN) , 8-14
MKR LIST on off , 8-4
MKR → START , 5-15
MKR → STOP , 5-15
MKR SEARCH , 8-16
MKR TIME on OFF , 8-11
MKR ZERO , 8-4
(M//μ) , 4-2
MODI1, 7-13
MODIFY , 7-13, 7-35
Modify cal kit menu, 7-35
MODIFY COLORS , 6-33
Modify colors menu, 6-34
MONDYEAR, 9-9
MONTH , 9-10
msH, 2-8, 5-2

N

N , 4-2
N 50Ω , 7-13
N 75Ω , 7-13
Network analyzer inputs R, A, and B, 2-5
NEXP, 10-17
NEXT PAGE , 10-17
Non-volatile memory, A-1
NUMBER of GROUPS , 5-2, 5-10
NUMBER of POINTS , 5-5, 5-15, 10-15
NUMG, 5-10

O

OFF , 6-8
OFFSET DELAY , 7-41
Offset limit menu, 9-21
OFFSET LOSS , 7-41
OFFSET ZO , 7-41
OFSD, 7-41
OFSL, 7-41
OFSZ, 7-41
Omitting isolation calibration, 7-10
ONE-PATH 2-PORT , 7-19
One-Path 2-Port Calibration, 7-31
One-path two-port calibration, 7-6
One-port calibration, 7-6

One-Port Error Model, 7-47
OPEP, 10-12
OPERATING PARAMETERS, 10-12
Option 001, 2-10
Option 002, 9-21
ORDER BASE, 5-12
Output power level, 5-5, 5-7

P

PARAMETER: Ls, 6-31
PARSOFF, 8-16
PARSON, 8-16
PART SRCH on OFF, 8-16
Pass/Fail, 2-7
P₁, 2-8, 5-7
PEADX, 8-19
PEADY, 8-19
PEAK DEF: AX(Y), 8-20
PEAK-PEAK, 8-19, 8-20
PHAO, 6-22
PHAS, 6-10
PHASE, 6-10
PHASE OFFSET, 6-22
PLOALL, 10-8
PLODGRAT, 10-8
PLODONLY, 10-8
PLOSFAST, 10-9
PLOSSLOW, 10-9
PLOT, 10-4, 10-16
PLOT, 10-4, 10-16
PLOT: ALL, 10-8
PLOT SPEED, 10-9
POIN, 5-5
Point, 1-4
POINT, 5-15
POLA, 6-11
POLAR, 6-11
Polar marker menu, 8-11
POLAR MKR MENU, 8-11
POLMLIN, 8-12
POLMLOG, 8-12
POLMRI, 8-12
POREOFF, 7-15
POREON, 7-15
PORT1, 7-16
PORT2, 7-16
PORTA, 7-16
PORTB, 7-16
PORT EXTENSIONS, 7-14
PORTR, 7-15
POWE, 5-5, 5-7, 5-16
POWER, 5-5, 5-7

power splitter, 1-2
POWER SWEEP, 5-12
Power sweep mode, 5-12
Power trip, 5-7
POWS, 5-12
PREP, 10-17
PRESET, 2-5, A-1
Preset state, A-1
PREV FILES, 11-12
PREV PAGE, 10-17
PRIC, 10-5
PRICFIXE, 10-6
PRICVARI, 10-6
PRINALL, 10-4, 10-16
PRINT COLOR [FIXED], 10-6
PRINT/PLOT SETUP, 10-5
PRINT/PLOT SETUPS, 10-16
PRINT: STANDARD, 10-5
PRINT [STANDARD], 10-4, 10-16
PRIS, 10-5
PROBE POWER connector, 2-5
PURG, 11-13
PURGE FILE, 11-13
Purge file menu, 11-14
PURGE: YES, 11-15

R

RAW ARY on OFF, 11-11
Raw data arrays, 11-1
REAL, 6-13
REAL, 6-13
Real format, 6-13
Rear panel, 2-9
RECALL, 11-6
RECALL COLORS, 6-33, 6-36
RECALL FILE, 11-17
Recall file menu, 11-18
Recall menu, 11-17
RECC, 6-33
RECD, 11-17
Recharge time, A-1
RED connector, 2-10
Reference level, 2-7
Reference plane menu, 7-15
REFERENCE POSITION, 6-20
REFERENCE VALUE, 6-20
Reflection coefficient, 6-5, 6-12, 7-47
Ref1: FWD S11 (A/R), 6-5
Ref1: REV S22 (B/R), 6-5
REF OVEN (Option 001) connector, 2-10

REFP, 6-20
REFV, 6-20
Remote mode, 9-3
RESAVD, 11-8
RE-SAVE FILE, 11-8
Re-save file menu, 11-12
RESC, 7-12
RESD, 10-17
RESET COLOR, 6-35
Response, 2-2
RESPONSE, 7-18, 7-44
Response and isolation calibration, 7-6, 7-22,
7-24, 7-45
Response calibration, 7-6, 7-20, 7-21, 7-44
Response function, 2-4, 6-1
RESPONSE & ISOLATION, 7-18, 7-45
REST, 5-6
RESTORE DISPLAY, 10-17
RESUME CAL SEQUENCE, 7-12
Reverse transmission coefficient, 6-5
REV.MATCH, 7-44
REV.TRANS., 7-44
RF OUT connector, 2-5
 ρ , 6-12
RIGHT LOWER, 10-7
RIGHT UPPER, 10-7
RIGL, 10-7
RIGU, 10-7
RMT, 2-8
RSCD, 6-35

S

S11, 6-5
S11 1-PORT, 7-18
S₁₁ 1-port calibration, 7-25, 7-44
S11B, 7-44
S11C, 7-44
S₁₁ one-port calibration, 7-6
S12, 6-5
S21, 6-5
S22, 6-5
S22 1-PORT, 7-19
S₂₂ 1-port calibration, 7-26, 7-44
S₂₂ one-port calibration, 7-6
SADD, 5-14
SAVCAOFF, 11-11
SAVCAON, 11-11
SAVDAL, 11-9
SAVDAOFF, 11-11
SAVDAON, 11-11
SAVDDAT, 11-9
SAVDSTA, 11-9
SAVE, 11-6
SAVE ALL, 11-9
SAVE COLORS, 6-33, 6-36
SAVE DATA ONLY, 11-9
SAVE FILE, 11-8
Save file menu, 11-9
SAVE STATE ONLY, 11-9
SAVEUSEK, 7-13
SAVE USER KIT, 7-13, 7-36
SAVMAOFF, 11-11
SAVMAON, 11-11
SAVRAOFF, 11-11
SAVRAON, 11-11
SAVTAOFF, 11-11
SAVTAON, 11-11
SAVTMAOFF, 11-11
SAVTMAON, 11-11
SAVUAOFF, 11-11
SAVUAON, 11-11
SCAC, 6-20
SCAFDATA, 6-20
SCAFMEMO, 6-20
SCAL, 6-20
Scale/Div, 2-7
SCALE/DIV, 6-20
SCALE FOR, 6-20
SCALE FULL, 10-9
SCALE PLOT, 10-8
Scale plot menu, 10-9
SCALE REF, 6-1, 6-19
Scale reference menu, 6-19
SCAPFULL, 10-9
SCAPGL, 10-9
SCAPGU, 10-9
scattering parameters, 6-3
SCAU, 6-20
Screen menu, 10-16
SDEL, 5-14
SDON, 5-16
SEAL, 8-18
SEALMAX, 8-19
SEALMIN, 8-19
SEAMAX, 8-17
SEAMEAN, 8-19
SEAMIN, 8-17
SEAOFF, 8-17
SEAPPEAK, 8-19
SEAR, 8-18
SEARCH IN, 8-21
SEARCH LEFT, 8-18

SEARCH: MEAN, 8-19
SEARCH: OFF, 8-17
SEARCH OUT, 8-21
SEARCH RANGE, 8-15
Search Range menu, 8-16
SEARCH RIGHT, 8-18
SEARCH RNG STORE, 8-16
SEARSTOR, 8-16
SEATARG, 8-17, 8-18
SEC, 9-9
SEDI, 5-14
Segment, 9-13
SEGMENT, 5-14, 9-18
SEGMENT DONE, 5-16
SEGMENT:POWER, 5-16
SEGMENT START, 5-16
SELCLSLP, 6-32
SELEC, 6-31
SELECCPCS, 6-32
SELECCPLS, 6-32
SELECCSCP, 6-32
SELECCSLP, 6-32
SELECLPCS, 6-32
SELECLPLS, 6-32
SELECLSCP, 6-32
Select cal kit menu, 7-12
Select circuit menu, 6-32
SELECT CKT [Ls-Lp], 6-31
SELECT LETTER, 6-29, 11-10
SELECT QUADRANT, 10-5
Serial number plate, 2-9
SERVICE MENU, 9-7
SET ADDRESSES, 9-5
SETCDATE, 9-8
SET CLOCK, 9-7
SETCTIME, 9-8
Set date menu, 9-10
Set time menu, 9-9
SETZ, 7-15
SET Z0, 7-15
SING, 5-10
SINGLE, 5-10
SMIC, 6-11
SMIMGB, 8-13
SMIMLIN, 8-12
SMIMLOG, 8-12
SMIMRI, 8-12
SMIMRX, 8-13
Smith chart, 6-11
SMITH CHART, 6-11
Smith marker menu, 8-12
SMITH MKR MENU, 8-11
Smo, 2-8, 6-40
SMOOPAPER, 6-40
SMOOSOFF, 6-40
SMOOSON, 6-40
Smoothing, 1-7, 6-38
Smoothing aperture, 6-40
SMOOTHING APERTURE, 6-40
SMOOTHING on OFF, 6-40
Softkey, 2-4
Softkey label, 2-7
Source match, 7-2, 7-3, 7-19, 7-47, 7-48, 7-52
SPACE, 6-29, 11-10
SPAN, 5-3, 5-16
SPAN, 5-3
SPAN, 5-16
S-parameter, 6-2, 6-3, 6-4
S PARAMETERS, 6-6
S-parameter test set, 1-2, 2-9, 5-8, 7-54
SPECFWDM, 7-44
SPECFWDT, 7-44
SPECIFY CLASS, 7-36
Specify class menu, 7-42
Specify offset menu, 7-41
SPECIFY: S11A, 7-44
SPECIFY: S22A, 7-44
SPECRESI, 7-45
SPECRESP, 7-44
SPECREVM, 7-44
SPECREVT, 7-44
SPECS11A, 7-44
SPECS11B, 7-44
SPECS11C, 7-44
SPECS22A, 7-44
SPECS22B, 7-44
SPECS22C, 7-44
SPLDOFF, 6-25
SPLDON, 6-25
Split display, 6-25
SPLIT DISP on OFF, 6-25
SPLIT DISP ON off, 6-24
SRQ, 2-8
Standard class assignment, A-8
STANDARD DEFINITION, 10-13
Standard device, 7-9, 7-12
Standard kit, A-6
STAR, 5-3, 5-16
START, 5-3
STATISTICS, 8-16
STD DONE(DEFINED), 7-40

STD NO.n , 7-37, 10-14
 STDTARBI, 7-40
 STDTDELA, 7-40
 STDTLOAD, 7-40
 STDTOPEN, 7-39
 STDTSHOR, 7-40
 STEP SIZE, 5-16, 10-15
 Stimulus, 1-4, 2-2, 5-5
 Stimulus function, 2-4, 5-1
 STIMULUS OFFSET , 9-21
 Stimulus start value, 2-7
 Stimulus stop value, 2-7
 STIMULUS VALUE , 9-19
 STOP, 5-16
 (STOP), 5-3
 STOP , 5-16
 STPSIZ, 5-16
 Svc, 2-8
 SVCO, 6-33
 Sweep, 1-4, 5-11
 SWEEP by: , 5-13
 SWEEP TIME[], 5-5
 SWEEP TIME, 5-8
 SWEEP TIME AUTO, 5-9
 Sweep time menu, 5-8
 SWEEP TYPE MENU, 5-7
 SWET, 5-8
 SWETAUTO, 5-9
 SWR, 6-12
 SWR , 6-12
 (SYSTEM), 9-7
 System controller, 9-4, 12-3, 12-4
 SYSTEM CONTROLLER, 9-4

T

Talker, 12-2
 TARGET, 8-17, 8-18
 Target menu, 8-18
 TER1, 7-40
 TERMINAL IMPEDANCE, 7-40
 Test set, 1-2
 TEST SET INTERCONNECT, 2-9
 TEXT , 6-34
 TIME HH:MM:SS, 9-8
 TINT, 6-35
 TINT , 6-35
 TITL, 6-25
 Title, 2-8, 6-28, 11-10
 TITLE , 6-25
 T.MEM ARY on OFF , 11-11

Trace arrays, 11-2
 TRACE ARY on OFF , 11-11
 Trace math menu, 6-27
 Trace math operation, 1-7
 Tracking, 7-2, 7-6, 7-19, 7-47, 7-49, 7-52
 TRACKING on OFF, 8-17
 TRACKOFF, 8-17
 TRACKON, 8-17
 Trans: FWD S21 (B/R), 6-5
 Transmission coefficient, 7-52
 Transmission/reflection test kit, 1-2, 2-9, 7-54
 Transmission/reflection test set, 6-4
 Trans: REV S12 (A/R), 6-5
 Trigger menu, 5-9
 TRIGGER MENU , 5-5
 TRIGGER: TRIG OFF, 5-10
 Two-Port Error Model, 7-52

U

U, 4-2
 UNCOUPLED, 8-11
 UNIFORM ARY on OFF, 11-11
 Unformat arrays, 11-2
 UPPER GRATICULE, 10-9
 UPPER LIMIT, 9-19
 User-defined cal kit, 7-34
 USER KIT, 7-13

V

VELOCITY FACTOR, 7-14
 VELOFACT, 7-14

W

WARNING, 6-34
 WIDSIN, 8-21
 WIDSON, 8-21
 Width menu, 8-21
 WIDTHS on OFF, 8-21
 WIDTH VALUE, 8-21
 WIDTOFF, 8-21
 WIDTON, 8-21
 WIDV, 8-21
 (x1), 4-2

Y

YEAR, 9-10
 Y: Ref1, 6-8
 Y: Trans, 6-8

Z

Z: Refl, 6-8

Z: Trans, 6-8

HP 8751A Network Analyzer
HP-IB Programming Manual



HP Part No. 08751-90003
Printed in Japan October 1990

Contents

1. General Information	
2. Programming Basics	
Preparing for HP-IB Control	2-1
Required Equipment	2-1
Optional Equipment	2-1
Powering Up the System	2-2
Measurement Programming	2-4
Basic Programming Examples	2-6
Setting Up a Measurement	2-6
Performing a Measurement Calibration	2-8
Calibration Kits	2-8
Frequency Response Calibration	2-9
1-Port Reflection Calibration	2-11
Data Transfer from the HP 8751A to a Computer	2-13
Using Markers to Obtain Trace Data at Specific Points	2-13
Trace Transfer	2-15
Data Format	2-15
Data Levels	2-16
Data Transfer Using ASCII Transfer Format (Form 4)	2-18
Data Transfer using IEEE 64-bit Floating Point Format (Form 3)	2-20
Application Example	2-22
Advanced Programming Examples	2-24
Using List Frequency Mode	2-24
Using Limit Lines to Perform Limit Testing	2-27
Storing and Recalling Instrument Status	2-29
Coordinating disk storage	2-29
Reading Calibration Data	2-31
Miscellaneous Programming Examples	2-34
Controlling Peripherals	2-34
Transferring disk data files	2-36
Status Reporting	2-38
3. HP-IB Programming Reference	
Notation	3-1
Query Commands	3-2
Suffix	3-3
Code Naming Conventions	3-3
Reference	3-4
AB	3-4
ABODCALI	3-4
ACTLHFRE	3-4

ACTLLFRE	3-4
ACTLNORM	3-4
ADDRCONT <i>value</i>	3-4
ADDRPLOT <i>value</i>	3-4
ADDRPRIN <i>value</i>	3-4
AR	3-5
ATTIA{0DB 20DB}	3-5
ATTIB{0DB 20DB}	3-5
ATTIR{0dB 20dB}	3-5
ATTP1 <i>value</i> [dB]	3-5
ATTP2 <i>value</i> [dB]	3-5
AUTO	3-5
AVERFACT <i>value</i>	3-5
AVER{ON OFF}	3-6
AVERREST	3-6
BACI <i>value</i>	3-6
BDC	3-6
BDCR	3-6
BEEPDONE{ON OFF}	3-6
BEEPFAIL{ON OFF}	3-6
BEEPWARN{ON OFF}	3-6
BR	3-6
C0 <i>value</i>	3-7
C1 <i>value</i>	3-7
C2 <i>value</i>	3-7
CALCASSI	3-7
CALI <i>parameter</i>	3-7
CALIFUL2	3-7
CALIONE2	3-7
CALIRAI	3-7
CALIRESP	3-8
CALIS111	3-8
CALIS221	3-8
CALK <i>parameter</i>	3-8
CALK7MM	3-8
CALKN50	3-8
CALKN75	3-8
CALKUSED	3-8
CALN	3-8
CALP	3-8
CALS <i>value</i>	3-9
CBRI <i>value</i>	3-9
CENT <i>value</i> [<i>suffix</i>]	3-9
CHAIRANG	3-9
CHAN1	3-9
CHAN2	3-9
CLAD	3-9
CLASS11{A B C}	3-9
CLASS22{A B C}	3-9
CLEL	3-10
CLEM{1-8}	3-10

CLES	3-10
CLEPTRIP	3-10
COLO{CH1D CH1M CH2D CH2M GRAT TEXT WARN}	3-10
COLOIBT	3-10
COLOR <i>value</i>	3-10
CONM{ON OFF}	3-10
CONPCP <i>value</i> [F]	3-10
CONPCS <i>value</i> [F]	3-11
CONPLP <i>value</i> [H]	3-11
CONPLS <i>value</i> [H]	3-11
CONPDISP{ON OFF}	3-11
CONT	3-11
CONV <i>parameter</i>	3-11
CONVIDS	3-11
CONVOFF	3-11
CONVYREF	3-12
CONVYTRA	3-12
CONVZREF	3-12
CONVZTRA	3-12
COPA	3-12
COPT{ON OFF}	3-12
CORR{ON OFF}	3-12
COUC{ON OFF}	3-12
CWFREQ <i>value</i> [<i>suffix</i>]	3-12
DATI	3-13
DAYMYEAR	3-13
DCBUS <i>value</i>	3-13
DCCOR{ON OFF}	3-13
DEFC	3-13
DEFS <i>value</i>	3-13
DELA	3-13
DELO	3-13
DELR{1-8}	3-13
DELRFIXM	3-14
DESTOFF	3-14
DESTON	3-14
DFLT	3-14
DISA <i>parameter</i>	3-14
DISAALLB	3-14
DISAALLI	3-14
DISABASS	3-14
DISAHHB	3-14
DISL{1 2}	3-15
DISLLIST	3-15
DISMCTSP	3-15
DISMMD	3-15
DISMNUM	3-15
DISMSTEP	3-15
DISMSTSP	3-15
DISMUL	3-15
DISP <i>parameter</i>	3-15

DISPDATA	3-16
DISPDATM	3-16
DISPDDM	3-16
DISPDMM	3-16
DISPMEMO	3-16
DONE	3-16
DUAC{ON OFF}	3-16
EDITDONE	3-16
EDITLIML	3-16
EDITLIS1	3-17
EDITLIS2	3-17
EDITLIST	3-17
ELED <i>value</i> [s]	3-17
ESB?	3-17
ESNB <i>value</i>	3-17
EXEDCALI	3-17
EXET	3-17
EXPP	3-17
EXTRLOCK?	3-18
EXTT <i>parameter</i>	3-18
EXTTOFF	3-18
EXTTON	3-18
EXTTPOIN	3-18
FBUS <i>value</i>	3-18
FIRLANOR	3-18
FIRLAOPE	3-18
FIRLPNOR	3-18
FIRLPOPE	3-19
FIRR?	3-19
FMT <i>parameter</i>	3-19
FNDAUTO	3-19
FNDMANU	3-19
FNDVALU <i>value</i>	3-19
FNVNORM	3-19
FNVOPEN	3-19
FREO	3-19
FORM2	3-20
FORM3	3-20
FORM4	3-20
FORM5	3-20
FULP	3-20
FWDI	3-20
FWDM	3-20
FWDT	3-20
GRODAPER <i>value</i> [pct]	3-20
HOLD	3-20
IFBW <i>value</i> [<i>suffix</i>]	3-21
IFBWAUTO	3-21
IFRAUTO	3-21
IFRCH?	3-21
IFRX1	3-21

IFRX1X8	3-21
IFRX64	3-21
IFRX8X1	3-21
IMAG	3-21
INID	3-22
INP8IO	3-22
INPUCALC{01-12} value	3-22
INPUCALK value	3-22
INPUDATA value	3-22
INPUFORM value	3-22
INPURAW{1-4} value	3-22
INPUUFORM value	3-22
INTE value	3-23
INVSCHAR	3-23
ISOD	3-23
ISOL	3-23
KEY value	3-23
KITD	3-23
LABEFWD{M T} string	3-23
LABERES{I P} string	3-23
LABEREV{M T} string	3-24
LABES11{A B C} string	3-24
LABES22{A B C} string	3-24
LABK string	3-24
LABS string	3-24
LEFL	3-24
LEFU	3-24
LIMCLEL	3-24
LIMD value [suffix]	3-25
LIMEDONE	3-25
LIMIAMPO value [suffix]	3-25
LIMILINE{ON OFF}	3-25
LIMIMAOF	3-25
LIMISTIO value [suffix]	3-26
LIMITEST{ON OFF}	3-26
LIML value [suffix]	3-26
LIMM value [suffix]	3-26
LIMS value [suffix]	3-27
LIMSADD	3-27
LIMSDEL	3-27
LIMSDON	3-27
LIMSEDI value	3-27
LIMU value [suffix]	3-27
LINFREQ	3-28
LINM	3-28
LINT{DATA MEMO} value	3-28
LISDFBASE	3-28
LISDOBASE	3-28
LISFREQ	3-28
LISSLIS1	3-28
LISSLIS2	3-28

LISV	3-28
LOGFREQ	3-29
LOGM	3-29
LOGMD	3-29
LOGMP	3-29
MANTRIG	3-29
MARK{1-8} <i>value [suffix]</i>	3-29
MARKBUCK <i>value</i>	3-29
MARKCENT	3-30
MARKCONT	3-30
MARKCOUP	3-30
MARKDELA	3-30
MARKDISC	3-30
MARKFAUV <i>value [suffix]</i>	3-30
MARKFSTI <i>value [suffix]</i>	3-30
MARKFVAL <i>value [suffix]</i>	3-30
MARKL{ON OFF}	3-31
MARKMIDD	3-31
MARKODATA	3-31
MARKOFF	3-31
MARKOMEMO	3-31
MARKPEAD	3-31
MARKREF	3-31
MARKSPAN	3-31
MARK{STAR STOP}	3-32
MARKSTIM	3-32
MARKTIME{ON OFF}	3-32
MARKUNCO	3-32
MARKZERO	3-32
MEAS <i>parameter</i>	3-32
MEASA	3-32
MEASB	3-32
MEASR	3-32
MEASTAT{ON OFF}	3-33
MIXLPNOR	3-33
MIXLPTES	3-33
MODII	3-33
MONDYEAR	3-33
NEXP	3-33
NUMG <i>value</i>	3-33
OFSD <i>value [s]</i>	3-33
OFSL <i>value</i>	3-34
OFSZ <i>value [ohm]</i>	3-34
OMII	3-34
OPEP	3-34
OSE <i>value</i>	3-34
OSR?	3-34
OUT8IO <i>value</i>	3-34
OUTPCALC{01-12}?	3-34
OUTPCALK?	3-34
OUTPDATA?	3-35

OUTPDATAP? <i>value</i>	3-35
OUTPERRO?	3-35
OUTPFAIP?	3-35
OUTPFBUS?	3-35
OUTPFORM?	3-35
OUTPFORMP? <i>value</i>	3-35
OUTPIFORM?	3-35
OUTPINPSIO?	3-35
OUTPIRFORM?	3-35
OUTPIRTMEM?	3-36
OUTPITMEM?	3-36
OUTPLIMF?	3-36
OUTPLIML?	3-36
OUTPLIMM?	3-36
OUTPMARK?	3-36
OUTPMEMO?	3-36
OUTPMEMOP? <i>value</i>	3-36
OUTPMSTA?	3-36
OUTPMWID?	3-36
OUTPRAW{1-4}?	3-37
OUTPRFORM?	3-37
OUTPRTMEM?	3-37
OUTPSTIM?	3-37
OUTPTESS? <i>value</i>	3-37
OUTPTITL?	3-37
OUTPTMEM?	3-37
OUTPTMEMP? <i>value</i>	3-37
OUTPUFORM?	3-37
PARS{ON OFF}	3-37
PEADX <i>value</i> [<i>suffix</i>]	3-38
PEADY <i>value</i> [<i>suffix</i>]	3-38
PHAO <i>value</i> [deg]	3-38
PHAS	3-38
PLOALL	3-38
PLOC <i>parameter</i>	3-39
PLODGRAT	3-39
PLODONLY	3-39
PLOS{FAST SLOW}	3-39
PLOT	3-39
POIN <i>value</i>	3-39
POLA	3-39
POLM <i>parameter</i>	3-39
POLMLIN	3-39
POLMLOG	3-40
POLMRI	3-40
PORE{ON OFF}	3-40
PORT1 <i>value</i> [s]	3-40
PORT2 <i>value</i> [s]	3-40
PORTA <i>value</i> [s]	3-40
PORTB <i>value</i> [s]	3-40
PORTR <i>value</i> [s]	3-40

POWDAUTO	3-41
POWDMAN	3-41
POWDVALU <i>value</i>	3-41
POWE <i>value</i> [dBm]	3-41
POWLANOR	3-41
POWLAOPE	3-41
POWS	3-41
PREP	3-41
PRES	3-41
PRINALL	3-41
PRIC	3-42
PRICFIXE	3-42
PRICVARI	3-42
PRIS	3-42
PSOFT{ON OFF}	3-42
PURG <i>string</i>	3-42
QUAD <i>parameter</i>	3-42
RAID	3-42
RAISOL	3-42
RAIRESP	3-43
REAL	3-43
RECC	3-43
RECCOFF	3-43
RECCON	3-43
RECD <i>string</i>	3-43
REFD	3-43
REFL	3-43
REFP <i>value</i>	3-43
REFV <i>value</i> [<i>suffix</i>]	3-44
RESAVD <i>string</i>	3-44
RESC	3-44
RESD	3-44
RESPDONE	3-44
REST	3-44
REVI	3-45
REVM	3-45
REVT	3-45
RFOPNORM	3-45
RFOPEN	3-45
RIGL	3-45
RIGU	3-45
RSCO	3-45
S11	3-45
S12	3-45
S21	3-46
S22	3-46
SADD	3-46
SAV1	3-46
SAV2	3-46
SAVC	3-46
SAVCA{ON OFF}	3-46

SAVDALL <i>string</i>	3-46
SAVDA{ON OFF}	3-46
SAVDDAT <i>string</i>	3-47
SAVDSTA <i>string</i>	3-47
SAVEUSEK	3-47
SAVMA{ON OFF}	3-47
SAVRA{ON OFF}	3-47
SAVTA{ON OFF}	3-47
SAVTMA{ON OFF}	3-47
SAVUA{ON OFF}	3-47
SCAC	3-48
SCAFDATA	3-48
SCAFMEMO	3-48
SCAL <i>value [suffix]</i>	3-48
SCAPFULL	3-48
SCAPGL	3-48
SCAPGU	3-48
SCAU	3-49
SDEL	3-49
SDON	3-49
SEAL	3-49
SEALMAX	3-49
SEALMIN	3-49
SEAM <i>parameter</i>	3-49
SEAMEAN	3-49
SEAMAX	3-49
SEAMIN	3-50
SEAOFF	3-50
SEAPPEAK	3-50
SEAR	3-50
SEARSTOR	3-50
SEATARG <i>value [suffix]</i>	3-50
SEDI <i>value</i>	3-50
SELC <i>parameter</i>	3-51
SELCCPCS	3-51
SELCCPLS	3-51
SELCCSCP	3-51
SELCCSLP	3-51
SELCLPCS	3-51
SELCLPLS	3-51
SELCLSCP	3-51
SELCLSLP	3-51
SELD	3-51
SETCDATE <i>year,month,day</i>	3-52
SETCTIME <i>hour,min,sec</i>	3-52
SETZ <i>value [ohm]</i>	3-52
SING	3-52
SMIC	3-52
SMIM <i>parameter</i>	3-52
SMIMGB	3-52
SMIMLIN	3-53

SMIMLOG	3-53
SMIMRI	3-53
SMIMRX	3-53
SMOOAPER <i>value</i> [pct]	3-53
SMOO{ON OFF}	3-53
SOUCOFF	3-53
SOUCON	3-53
SPAN <i>value</i> [<i>suffix</i>]	3-53
SPECFWDM A[,B[,C[,D[,E[,F[,G]]]]]]	3-54
SPECFWDT A[,B[,C[,D[,E[,F[,G]]]]]]	3-54
SPECRESI A[,B[,C[,D[,E[,F[,G]]]]]]	3-54
SPECRESP A[,B[,C[,D[,E[,F[,G]]]]]]	3-54
SPECREVM A[,B[,C[,D[,E[,F[,G]]]]]]	3-54
SPECREVT A[,B[,C[,D[,E[,F[,G]]]]]]	3-54
SPECS11A A[,B[,C[,D[,E[,F[,G]]]]]]	3-55
SPECS11B A[,B[,C[,D[,E[,F[,G]]]]]]	3-55
SPECS11C A[,B[,C[,D[,E[,F[,G]]]]]]	3-55
SPECS22A A[,B[,C[,D[,E[,F[,G]]]]]]	3-55
SPECS22B A[,B[,C[,D[,E[,F[,G]]]]]]	3-55
SPECS22C A[,B[,C[,D[,E[,F[,G]]]]]]	3-55
SPLD{ON OFF}	3-56
STAN{A-G}	3-56
STAR <i>value</i> [<i>suffix</i>]	3-56
STDD	3-56
STDT <i>parameter</i>	3-56
STDTARBI	3-56
STDTDELA	3-56
STDTLOAD	3-56
STDTOPEN	3-57
STDTSHOR	3-57
STEODAUT	3-57
STEODMAN	3-57
STEODVAL <i>value</i>	3-57
STEONORM	3-57
STEOOPEN	3-57
STOP <i>value</i> [<i>suffix</i>]	3-57
STPSIZE <i>value</i> [<i>suffix</i>]	3-57
SVCO	3-58
SWET <i>value</i> [s]	3-58
SWETAUTO	3-58
SWPT <i>parameter</i>	3-58
SWR	3-58
TERI <i>value</i> [ohm]	3-58
TESC	3-58
TESS?	3-58
TEST <i>value</i>	3-58
TINT <i>value</i>	3-59
TITL <i>string</i>	3-59
TRACK{ON OFF}	3-59
TRAD	3-59
TRAN	3-59

VELOFACT <i>value</i>	3-59
WIDSIN	3-59
WIDSOUT	3-59
WIDT{ON OFF}	3-60
WIDV <i>value</i> [<i>suffix</i>]	3-60
*CLS	3-60
*ESE <i>value</i>	3-60
*ESR?	3-60
*IDN?	3-60
*OPC	3-60
*PCB <i>value</i>	3-61
*RST	3-61
*SRE <i>value</i>	3-61
*STB?	3-61
*TRG	3-61
*TST?	3-61
*WAI	3-61

A. HP-IB Commands Summary

Active Channel Block	A-1
Response Function Block	A-1
MEAS Key	A-1
Input Port Menu	A-1
S-Parameter Menu	A-1
Conversion Menu	A-2
FORMAT Key	A-2
Format Menu	A-2
Format More Menu	A-2
SCALE REF Key	A-2
Scale Reference Menu	A-2
Electrical Delay Menu	A-3
DISPLAY Key	A-3
Display Menu	A-3
Display More Menu	A-3
Display Allocation Menu	A-3
Trace Math Menu	A-3
Conjugate Matching Menu	A-3
Select Circuit Menu	A-4
Adjust Display Menu	A-4
Modify Colors Menu	A-4
Color Adjust Menu	A-4
AVG Key	A-5
Average Menu	A-5
IF Bandwidth Menu	A-5
CAL Key	A-5
Correction Menu	A-5
Select Cal Kit Menu	A-5
Calibrate More Menu	A-5
Reference Plane Menu	A-5
DC Correction Menu	A-6
Calibration Menu	A-6

Response Cal Menu	A-6
Response and Isoiation Cal Menu	A-6
S11 and S22 1-Port Cal Menus	A-6
Full 2-Port Cal Menus	A-6
One-Path 2-Port Cal Menus	A-7
Modify Cal Kit Menu	A-7
Define Standard Menus	A-8
Specify Offset Menu	A-8
Specify Class Menus	A-8
Label Class Menus	A-9
MKR Key	A-9
Marker Menu	A-9
Active Marker Menu	A-9
Clear Marker Menu	A-9
Delta Marker Mode Menu	A-9
Delta Marker Menu	A-9
Fixed Marker Menu	A-10
Marker Mode Menu	A-10
Polar Marker Menu	A-10
Smith Marker Menu	A-10
MKR FCTN Key	A-10
Marker Function Menu	A-10
Search Range Menu	A-10
Marker Search Menu	A-11
Target Menu	A-11
Marker Search More Menu	A-11
Width Menu	A-11
ATTEN Key	A-11
Stimulus Function Block	A-12
MENU Key	A-12
Stimulus Menu	A-12
Power Menu	A-12
Sweep Time Menu	A-12
Trigger Menu	A-12
Sweep Type Menu	A-12
List Sweep Menu	A-13
Edit List Menu	A-13
Edit Segment Menu	A-13
Edit Segment More Menu	A-13
Clear List Menu	A-13
Instrument State Function Block	A-14
SYSTEM Key	A-14
Real Time Clock Menu	A-14
Limits Menu	A-14
Edit Limits Menu	A-14
Edit Segment Menu	A-14
Clear List Menu	A-14
Offset Limit Menu	A-14
LOCAL Key	A-15
PRESET Key	A-15
COPY Key	A-15

Copy Menu	A-15
Print/Plot Setup Menu	A-15
Select Quadrant Menu	A-15
Define Plot Menu	A-15
Scale Plot Menu	A-16
Copy More Menu	A-16
Copy Cal Kit Menu	A-16
Copy Standard Number Menu	A-16
Copy List Sweep Menu	A-16
Copy Limit Test Menu	A-16
Screen Menu	A-16
SAVE and RECALL Keys	A-17
Save Menu	A-17
Define Save Menu	A-17
Define Save Date Menu	A-17
Disk Menu	A-17
Recall Menu	A-17
Service Function	A-17
Commands Which Don't Have Equivalent Softkey Labels	A-19
IEEE 488.2 Common Commands	A-20

B. Status Reporting

C. Key Codes

D. Calibration Types and Standard Classes, and Calibration Arrays

Messages

ERROR MESSAGES IN ALPHABETICAL ORDER	Messages-1
ERROR MESSAGES IN NUMERICAL ORDER	Messages-14

Figures

2-1. HP-IB Connections in a Typical Setup	2-2
2-2. Typical Measurement Sequence	2-4
2-3. Sample Program: Setting Up a Measurement	2-6
2-4. Sample Program: Frequency Response Calibration	2-9
2-5. 1-port Reflection Calibration	2-12

Tables

2-1. Units as a Function of Display Format	2-14
3-1. HP-IB Code Naming Convention	3-3
B-1. Status Bit Definitions of the Status Byte (STB)	B-2
B-2. Status Bit Definitions of the Event Status Register (ESR)	B-3
B-3. Status Bit Definitions of the Event Status Register B (ESB)	B-4
B-4. Status Bit Definitions of the Operational Status Register (OSR)	B-4
D-1. Calibration Types and Standard Classes	D-1
D-2. Calibration Array	D-2

General Information

This manual is an introduction to remote operation of the HP 8751A Network Analyzer using an HP 9000 series 200 or 300 computer. It is a tutorial introduction, using BASIC programming examples. The following is a brief description of each chapter and appendix.

Chapter 2 describes programming basics and provides example programs.

Chapter 3 lists HP-IB commands in alphabetic order.

Appendix A summarizes HP-IB commands according to the softkey labels.

Appendix B describes the status byte register and the other registers of the HP 8751A.

Appendix C provides the codes of the front panel keys for using the KEY HP-IB command.

Appendix D describes the calibration types and the standard classes, and the calibration coefficients.

Error Messages lists error messages with explanations.

The reader should become familiar with the operation of the HP 8751A before controlling it over HP-IB. This manual is not intended to teach BASIC programming or to discuss HP-IB theory; refer to the following documents which are better suited to these tasks.

- For more information concerning the operation of the HP 8751A, refer to the following:

HP 8751A User's Guide

HP 8751A Reference Manual

- For more information concerning BASIC, refer to the manual set for the BASIC revision being used:

BASIC Programming Techniques

BASIC Language Reference

- For more information concerning HP-IB, refer to the following:

BASIC Interfacing Techniques

Tutorial Description of the Hewlett-Packard Interface Bus

Condensed Description of the Hewlett-Packard Interface Bus

Programming Basics

This chapter describes programming basics and provides example programs.

Preparing for HP-IB Control

To run the examples in this chapter, the following equipment is required:

Required Equipment

1. HP 8751A Network Analyzer
2. HP 9000 Series 200 or 300 computer with enough memory to hold BASIC, needed binaries (refer to "Powering Up the System"), and at least 64 kilobytes of program space.
A disk drive is required to load BASIC, if no internal disk drive is available.
3. BASIC 3.0 or higher operating system.
4. HP 10833A/B/C/D HP-IB cables to interconnect the computer, the HP 8751A, and any peripherals.

Optional Equipment

1. HP 87511A S-parameter Test Set
2. HP 85032B 50 Ω type-N calibration kit
3. HP 11857D Cable Kit
4. Accessory kit
5. Device under test (DUT)
6. Cables to connect DUT
7. Printer

Powering Up the System

1. Set up the HP 8751A as shown in Figure 2-1.

Connect the HP 8751A to the computer with an HP-IB cable.

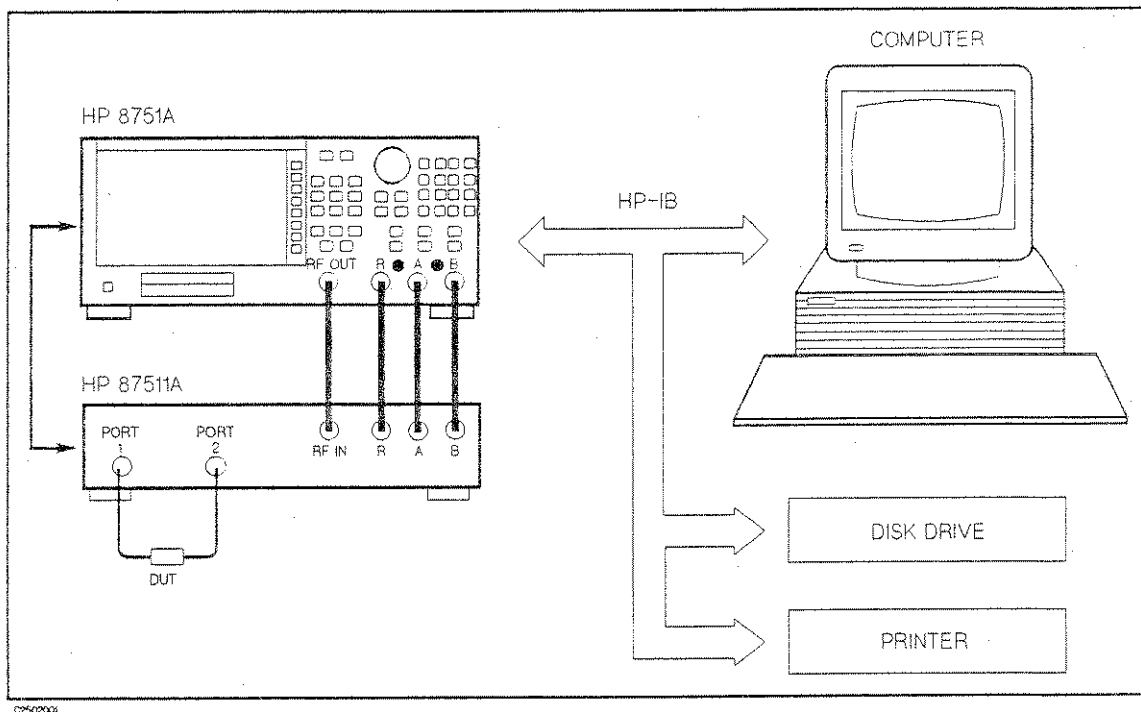

Figure 2-1. HP-IB Connections in a Typical Setup

2. Turn on the computer and load the BASIC operating system.

Load the following BASIC binary extensions:

HPIB, GRAPH, IO, KBD, and ERR.

Depending on the disk drive, a binary such as CS80 may be required.

3. Turn the HP 8751A ON.

To verify the HP 8751A's address, press **LOCAL** and select **SET ADDRESSES**

ADDRESS: 8751. If the address has been changed from the default value (17), return it to 17 while performing the examples in this document by pressing **1** **7** **x1** and the presetting the HP 8751A.

Make sure the HP 8751A is in the **ADDRESSABLE ONLY** mode, as indicated under the **LOCAL** key. This is the only mode in which the HP 8751A will accept HP-IB commands.

4. On the computer, type the following:

OUTPUT 717;"PRES" **Return** (or **EXECUTE**)

This will preset the HP 8751A. If preset does not occur, there is a problem. First check all HP-IB addresses and connections: most HP-IB problems are caused by an incorrect address and bad or loose HP-IB cables.

2-2 Programming Basics

Note



Only the HP 9000 Model 226 and 236 computers have an **EXECUTE** key. The Model 216 has an **EXEC** key with the same function. All other computer use the **Return** key as both execute and enter. The notation **Return** is used in this document.

Measurement Programming

This section describes how to organize the commands into a measurement sequence. Figure 2-2 shows a typical measurement sequence.

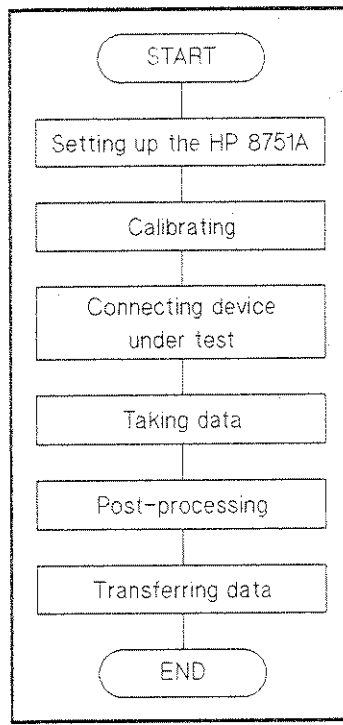

Figure 2-2. Typical Measurement Sequence

■ Setting up the HP 8751A

Define the measurement by setting all of the basic measurement parameters. These include all the stimulus parameters: sweep type, span, sweep time, number of points, and RF power level. They also include the parameter to be measured, and both IF averaging and IF bandwidth. These parameters define the way data is gathered and processed within the instrument, and to change one requires that a new sweep be triggered.

There are other parameters that can be set within the HP 8751A that do not affect data gathering directly, such as smoothing, trace scaling or trace math. These functions are classed as post processing functions: they can be changed with the HP 8751A in the hold mode, and the data will correctly reflect the current state.

The save/recall registers provide a rapid way of setting up an entire instrument state.

■ Calibrating

Measurement calibration is normally performed once the HP 8751A state has been defined. Measurement calibration is not required to make a measurement, but it does improve measurement accuracy.

There are several ways to calibrate the HP 8751A as follows:

- The simplest is to stop the program and have the operator perform the calibration from the front panel.

- Alternatively, the computer can be used to guide the operator through the calibration, as discussed in "Frequency Response Calibration" and "1-Port Reflection Calibration".
- The last option is to transfer calibration data from a previous calibration back into the instrument, as discussed in "Reading Calibration Data".

■ Connecting device under test

Have the operator connect and adjust the device. The computer can be used to speed the adjustment process by setting up such functions as limit testing, bandwidth searches, and trace statistics. All adjustments take place at this stage so that there is no danger of taking data from the device while it is being adjusted.

■ Taking data

With the device connected and adjusted, measure its frequency response, and store the data in the HP 8751A so that there is a valid trace to analyze.

The single sweep command SING is designed to ensure a valid sweep. All stimulus changes are completed before the sweep is started, and the HP-IB hold state is not released until the formatted trace is displayed. When the sweep is complete, the HP 8751A is put into the hold mode, storing the data inside the HP 8751A.

The number of groups commands NUMGn is designed to work the same as single sweep, except that it triggers n sweeps. This is useful, for example, in making a measurement with an averaging factor of n. Both single sweep and number of groups restart averaging.

■ Post-processing

With valid data to operate on, the post-processing functions can be used. Referring ahead to Figure 2-9, any function that affects the data after the error correction stage can be used. The most useful functions are trace statistics, marker searches, and electrical delay offset. If a 2-port calibration is active, then any of the four S-parameters can be viewed without taking a new sweep.

■ Transferring data

Lastly, read the results out of the HP 8751A. All the data output commands are designed to ensure that the data transmitted reflects the current state of the HP 8751A:

- OUTPDATA, OUTPRAWn, OUTPFORM, etc. will not transmit data until all formatting functions have been completed.
- OUTPLIML, OUTPLIMM, and OUTPLIMF will not transmit data until the limit test has occurred, if turned ON.
- OUTPMARK will activate a marker if one is not already selected, and it will make sure that any current marker searches have completed before transmitting data.
- OUTPMSTA makes sure that statistics have been calculated for the current trace before transmitting data. If statistics is not turned on, it will turn statistics on to update the current values, and then turn it OFF.
- OUTPMWID makes sure that a bandwidth search has been executed for the current trace before transmitting data. If bandwidth search is not turned on, it will turn the search on to update the current values, and then turn it OFF.

Data transfer is discussed further in "Data Transfer from the HP 8751A to a Computer".

Basic Programming Examples

Setting Up a Measurement

In general, the procedure for setting up measurements on the HP 8751A via HP-IB follows the same sequence as if the setup was performed manually. There is no required order, as long as the desired frequency range, number of points and power level are set prior to performing the calibration.

By interrogating the HP 8751A to determine the actual values of the start, the stop, or the center frequencies, or the frequency span, the computer can keep track of the actual frequencies.

This example illustrates how a basic measurement can be set up on the HP 8751A. The program will first select the desired parameter, the measurement format, and then the frequency range.

This example sets up a measurement of transmission log magnitude on channel 1. When prompted for the center frequency and the frequency span, enter any value in Hz from 1.0E+5 (for the S-parameter Test Set) to 5.0E+8. These will be entered into the HP 8751A, and the frequencies will be displayed.

```
10      !
11      !
12      ! Setting Up a Measurement
13      !
14      !
15      !
16      !
17      !
18      !
19      !
20      !
21      !
22      !
23      !
24      !
25      !
26      !
27      !
28      !
29      !
30      !
31      !
32      !
33      !
34      !
35      !
36      !
37      !
38      !
39      !
40      !
41      !
42      !
43      !
44      !
45      !
46      !
47      !
48      !
49      !
50      !
51      !
52      !
53      !
54      !
55      !
56      !
57      !
58      !
59      !
60      !
61      !
62      !
63      !
64      !
65      !
66      !
67      !
68      !
69      !
70      !
71      !
72      !
73      !
74      !
75      !
76      !
77      !
78      !
79      !
80      !
81      !
82      !
83      !
84      !
85      !
86      !
87      !
88      !
89      !
90      !
91      !
92      !
93      !
94      !
95      !
96      !
97      !
98      !
99      !
100     !
101     !
102     !
103     !
104     !
105     !
106     !
107     !
108     !
109     !
110     !
111     !
112     !
113     !
114     !
115     !
116     !
117     !
118     !
119     !
120     !
121     !
122     !
123     !
124     !
125     !
126     !
127     !
128     !
129     !
130     !
131     !
132     !
133     !
134     !
135     !
136     !
137     !
138     !
139     !
140     !
141     !
142     !
143     !
144     !
145     !
146     !
147     !
148     !
149     !
150     !
151     !
152     !
153     !
154     !
155     !
156     !
157     !
158     !
159     !
160     !
161     !
162     !
163     !
164     !
165     !
166     !
167     !
168     !
169     !
170     !
171     !
172     !
173     !
174     !
175     !
176     !
177     !
178     !
179     !
180     !
181     !
182     !
183     !
184     !
185     !
186     !
187     !
188     !
189     !
190     !
191     !
192     !
193     !
194     !
195     !
196     !
197     !
198     !
199     !
200     !
201     !
202     !
203     !
204     !
205     !
206     !
207     !
208     !
209     !
210     !
211     !
212     !
213     !
214     !
215     !
216     !
217     !
218     !
219     !
220     !
221     !
222     !
223     !
224     !
225     !
226     !
227     !
228     !
229     !
230     !
231     !
232     !
233     !
234     !
235     !
236     !
237     !
238     !
239     !
240     !
241     !
242     !
243     !
244     !
245     !
246     !
247     !
248     !
249     !
250     !
251     !
252     !
253     !
254     !
255     !
256     !
257     !
258     !
259     !
260     !
261     !
262     !
263     !
264     !
265     !
266     !
267     !
268     !
269     !
270     !
271     !
272     !
273     !
274     !
275     !
276     !
277     !
278     !
279     !
280     !
281     !
282     !
283     !
284     !
285     !
286     !
287     !
288     !
289     !
290     !
291     !
292     !
293     !
294     !
295     !
296     !
297     !
298     !
299     !
300     !
301     !
302     !
303     !
304     !
305     !
306     !
307     !
308     !
309     !
310     !
311     !
312     !
313     !
314     !
315     !
316     !
317     !
318     !
319     !
320     !
321     !
322     !
323     !
324     !
325     !
326     !
327     !
328     !
329     !
330     !
331     !
332     !
333     !
334     !
335     !
336     !
337     !
338     !
339     !
340     !
341     !
342     !
343     !
344     !
345     !
346     !
347     !
348     !
349     !
350     !
351     !
352     !
353     !
354     !
355     !
356     !
357     !
358     !
359     !
360     !
361     !
362     !
363     !
364     !
365     !
366     !
367     !
368     !
369     !
370     !
371     !
372     !
373     !
374     !
375     !
376     !
377     !
378     !
379     !
380     !
381     !
382     !
383     !
384     !
385     !
386     !
387     !
388     !
389     !
390     !
391     !
392     !
393     !
394     !
395     !
396     !
397     !
398     !
399     !
400     !
401     !
402     !
403     !
404     !
405     !
406     !
407     !
408     !
409     !
410     !
411     !
412     !
413     !
414     !
415     !
416     !
417     !
418     !
419     !
420     !
421     !
422     !
423     !
424     !
425     !
426     !
427     !
428     !
429     !
430     !
431     !
432     !
433     !
434     !
435     !
436     !
437     !
438     !
439     !
440     !
441     !
442     !
443     !
444     !
445     !
446     !
447     !
448     !
449     !
450     !
451     !
452     !
453     !
454     !
455     !
456     !
457     !
458     !
459     !
460     !
461     !
462     !
463     !
464     !
465     !
466     !
467     !
468     !
469     !
470     !
471     !
472     !
473     !
474     !
475     !
476     !
477     !
478     !
479     !
480     !
481     !
482     !
483     !
484     !
485     !
486     !
487     !
488     !
489     !
490     !
491     !
492     !
493     !
494     !
495     !
496     !
497     !
498     !
499     !
500     !
501     !
502     !
503     !
504     !
505     !
506     !
507     !
508     !
509     !
510     !
511     !
512     !
513     !
514     !
515     !
516     !
517     !
518     !
519     !
520     !
521     !
522     !
523     !
524     !
525     !
526     !
527     !
528     !
529     !
530     !
531     !
532     !
533     !
534     !
535     !
536     !
537     !
538     !
539     !
540     !
541     !
542     !
543     !
544     !
545     !
546     !
547     !
548     !
549     !
550     !
551     !
552     !
553     !
554     !
555     !
556     !
557     !
558     !
559     !
560     !
561     !
562     !
563     !
564     !
565     !
566     !
567     !
568     !
569     !
570     !
571     !
572     !
573     !
574     !
575     !
576     !
577     !
578     !
579     !
580     !
581     !
582     !
583     !
584     !
585     !
586     !
587     !
588     !
589     !
590     !
591     !
592     !
593     !
594     !
595     !
596     !
597     !
598     !
599     !
600     !
601     !
602     !
603     !
604     !
605     !
606     !
607     !
608     !
609     !
610     !
611     !
612     !
613     !
614     !
615     !
616     !
617     !
618     !
619     !
620     !
621     !
622     !
623     !
624     !
625     !
626     !
627     !
628     !
629     !
630     !
631     !
632     !
633     !
634     !
635     !
636     !
637     !
638     !
639     !
640     !
641     !
642     !
643     !
644     !
645     !
646     !
647     !
648     !
649     !
650     !
651     !
652     !
653     !
654     !
655     !
656     !
657     !
658     !
659     !
660     !
661     !
662     !
663     !
664     !
665     !
666     !
667     !
668     !
669     !
670     !
671     !
672     !
673     !
674     !
675     !
676     !
677     !
678     !
679     !
680     !
681     !
682     !
683     !
684     !
685     !
686     !
687     !
688     !
689     !
690     !
691     !
692     !
693     !
694     !
695     !
696     !
697     !
698     !
699     !
700     !
701     !
702     !
703     !
704     !
705     !
706     !
707     !
708     !
709     !
710     !
711     !
712     !
713     !
714     !
715     !
716     !
717     !
718     !
719     !
720     !
721     !
722     !
723     !
724     !
725     !
726     !
727     !
728     !
729     !
730     !
731     !
732     !
733     !
734     !
735     !
736     !
737     !
738     !
739     !
740     !
741     !
742     !
743     !
744     !
745     !
746     !
747     !
748     !
749     !
750     !
751     !
752     !
753     !
754     !
755     !
756     !
757     !
758     !
759     !
760     !
761     !
762     !
763     !
764     !
765     !
766     !
767     !
768     !
769     !
770     !
771     !
772     !
773     !
774     !
775     !
776     !
777     !
778     !
779     !
780     !
781     !
782     !
783     !
784     !
785     !
786     !
787     !
788     !
789     !
790     !
791     !
792     !
793     !
794     !
795     !
796     !
797     !
798     !
799     !
800     !
801     !
802     !
803     !
804     !
805     !
806     !
807     !
808     !
809     !
810     !
811     !
812     !
813     !
814     !
815     !
816     !
817     !
818     !
819     !
820     !
821     !
822     !
823     !
824     !
825     !
826     !
827     !
828     !
829     !
830     !
831     !
832     !
833     !
834     !
835     !
836     !
837     !
838     !
839     !
840     !
841     !
842     !
843     !
844     !
845     !
846     !
847     !
848     !
849     !
850     !
851     !
852     !
853     !
854     !
855     !
856     !
857     !
858     !
859     !
860     !
861     !
862     !
863     !
864     !
865     !
866     !
867     !
868     !
869     !
870     !
871     !
872     !
873     !
874     !
875     !
876     !
877     !
878     !
879     !
880     !
881     !
882     !
883     !
884     !
885     !
886     !
887     !
888     !
889     !
890     !
891     !
892     !
893     !
894     !
895     !
896     !
897     !
898     !
899     !
900     !
901     !
902     !
903     !
904     !
905     !
906     !
907     !
908     !
909     !
910     !
911     !
912     !
913     !
914     !
915     !
916     !
917     !
918     !
919     !
920     !
921     !
922     !
923     !
924     !
925     !
926     !
927     !
928     !
929     !
930     !
931     !
932     !
933     !
934     !
935     !
936     !
937     !
938     !
939     !
940     !
941     !
942     !
943     !
944     !
945     !
946     !
947     !
948     !
949     !
950     !
951     !
952     !
953     !
954     !
955     !
956     !
957     !
958     !
959     !
960     !
961     !
962     !
963     !
964     !
965     !
966     !
967     !
968     !
969     !
970     !
971     !
972     !
973     !
974     !
975     !
976     !
977     !
978     !
979     !
980     !
981     !
982     !
983     !
984     !
985     !
986     !
987     !
988     !
989     !
990     !
991     !
992     !
993     !
994     !
995     !
996     !
997     !
998     !
999     !
1000    !
1001    !
1002    !
1003    !
1004    !
1005    !
1006    !
1007    !
1008    !
1009    !
1010    !
1011    !
1012    !
1013    !
1014    !
1015    !
1016    !
1017    !
1018    !
1019    !
1020    !
1021    !
1022    !
1023    !
1024    !
1025    !
1026    !
1027    !
1028    !
1029    !
1030    !
1031    !
1032    !
1033    !
1034    !
1035    !
1036    !
1037    !
1038    !
1039    !
1040    !
1041    !
1042    !
1043    !
1044    !
1045    !
1046    !
1047    !
1048    !
1049    !
1050    !
1051    !
1052    !
1053    !
1054    !
1055    !
1056    !
1057    !
1058    !
1059    !
1060    !
1061    !
1062    !
1063    !
1064    !
1065    !
1066    !
1067    !
1068    !
1069    !
1070    !
1071    !
1072    !
1073    !
1074    !
1075    !
1076    !
1077    !
1078    !
1079    !
1080    !
1081    !
1082    !
1083    !
1084    !
1085    !
1086    !
1087    !
1088    !
1089    !
1090    !
1091    !
1092    !
1093    !
1094    !
1095    !
1096    !
1097    !
1098    !
1099    !
1100    !
1101    !
1102    !
1103    !
1104    !
1105    !
1106    !
1107    !
1108    !
1109    !
1110    !
1111    !
1112    !
1113    !
1114    !
1115    !
1116    !
1117    !
1118    !
1119    !
1120    !
1121    !
1122    !
1123    !
1124    !
1125    !
1126    !
1127    !
1128    !
1129    !
1130    !
1131    !
1132    !
1133    !
1134    !
1135    !
1136    !
1137    !
1138    !
1139    !
1140    !
1141    !
1142    !
1143    !
1144    !
1145    !
1146    !
1147    !
1148    !
1149    !
1150    !
1151    !
1152    !
1153    !
1154    !
1155    !
1156    !
1157    !
1158    !
1159    !
1160    !
1161    !
1162    !
1163    !
1164    !
1165    !
1166    !
1167    !
1168    !
1169    !
1170    !
1171    !
1172    !
1173    !
1174    !
1175    !
1176    !
1177    !
1178    !
1179    !
1180    !
1181    !
1182    !
1183    !
1184    !
1185    !
1186    !
1187    !
1188    !
1189    !
1190    !
1191    !
1192    !
1193    !
1194    !
1195    !
1196    !
1197    !
1198    !
1199    !
1200    !
1201    !
1202    !
1203    !
1204    !
1205    !
1206    !
1207    !
1208    !
1209    !
1210    !
1211    !
1212    !
1213    !
1214    !
1215    !
1216    !
1217    !
1218    !
1219    !
1220    !
1221    !
1222    !
1223    !
1224    !
1225    !
1226    !
1227    !
1228    !
1229    !
1230    !
1231    !
1232    !
1233    !
1234    !
1235    !
1236    !
1237    !
1238    !
1239    !
1240    !
1241    !
1242    !
1243    !
1244    !
1245    !
1246    !
1247    !
1248    !
1249    !
1250    !
1251    !
1252    !
1253    !
1254    !
1255    !
1256    !
1257    !
1258    !
1259    !
1260    !
1261    !
1262    !
1263    !
1264    !
1265    !
1266    !
1267    !
1268    !
1269    !
1270    !
1271    !
1272    !
1273    !
1274    !
1275    !
1276    !
1277    !
1278    !
1279    !
1280    !
1281    !
1282    !
1283    !
1284    !
1285    !
1286    !
1287    !
1288    !
1289    !
1290    !
1291    !
1292    !
1293    !
1294    !
1295    !
1296    !
1297    !
1298    !
1299    !
1300    !
1301    !
1302    !
1303    !
1304    !
1305    !
1306    !
1307    !
1308    !
1309    !
1310    !
1311    !
1312    !
1313    !
1314    !
1315    !
1316    !
1317    !
1318    !
1319    !
1320    !
1321    !
1322    !
1323    !
1324    !
1325    !
1326    !
1327    !
1328    !
1329    !
1330    !
1331    !
1332    !
1333    !
1334    !
1335    !
1336    !
1337    !
1338    !
1339    !
1340    !
1341    !
1342    !
1343    !
1344    !
1345    !
1346    !
1347    !
1348    !
1349    !
1350    !
1351    !
1352    !
1353    !
1354    !
1355    !
1356    !
1357    !
1358    !
1359    !
1360    !
1361    !
1362    !
1363    !
1364    !
1365    !
1366    !
1367    !
1368    !
1369    !
1370    !
1371    !
1372    !
1373    !
1374    !
1375    !
1376    !
1377    !
1378    !
1379    !
1380    !
1381    !
1382    !
1383    !
1384    !
1385    !
1386    !
1387    !
1388    !
1389    !
1390    !
1391    !
1392    !
1393    !
1394    !
1395    !
1396    !
1397    !
1398    !
1399    !
1400    !
1401    !
1402    !
1403    !
1404    !
1405    !
1406    !
1407    !
1408    !
1409    !
1410    !
1411    !
1412    !
1413    !
1414    !
1415    !
1416    !
1417    !
1418    !
1419    !
1420    !
1421    !
1422    !
1423    !
1424    !
1425    !
1426    !
1427    !
1428    !
1429    !
1430    !
1431    !
1432    !
1433    !
1434    !
1435    !
1436    !
1437    !
1438    !
1439    !
1440    !
1441    !
1442    !
1443    !
1444    !
1445    !
1446    !
1447    !
1448    !
1449    !
1450    !
1451    !
1452    !
1453    !
1454    !
1455    !
1456    !
1457    !
1458    !
1459    !
1460    !
1461    !
1462    !
1463    !
1464    !
1465    !
1466    !
1467    !
1468    !
1469    !
1470    !
1471    !
1472    !
1473    !
1474    !
1475    !
1476    !
1477    !
1478    !
1479    !
1480    !
1481    !
1482    !
1483    !
1484    !
1485    !
1486    !
1487    !
1488    !
1489    !
1490    !
1491    !
1492    !
1493    !
1494    !
1495    !
1496    !
1497    !
1498    !
1499    !
1500    !
1501    !
1502    !
1503    !
1504    !
1505    !
1506    !
1507    !
1508    !
1509    !
1510    !
1511    !
1512    !
1513    !
1514    !
1515    !
1516    !
1517    !
1518    !
1519    !
1520    !
1521    !
1522    !
1523    !
1524    !
1525    !
1526    !
1527    !
1528    !
1529    !
1530    !
1531    !
1532    !
1533    !
1534    !
1535    !
1536    !
1537    !
1538    !
1539    !
1540    !
1541    !
1542    !
1543    !
1544    !
1545    !
1546    !
1547    !
1548    !
1549    !
1550    !
1551    !
1552    !
1553    !
1554    !
1555    !
1556    !
1557    !
1558    !
1559    !
1560    !
1561    !
1562    !
1563    !
1564    !
1565    !
1566    !
1567    !
1568    !
1569    !
1570    !
1571    !
1572    !
1573    !
1574    !
1575    !
1576    !
1577    !
1578    !
1579    !
1580    !
1581    !
1582    !
1583    !
1584    !
1585    !
1586    !
1587    !
1588    !
1589    !
1590    !
1591    !
1592    !
1593    !
1594    !
1595    !
1596    !
1597    !
1598    !
1599    !
1600    !
1601    !
1602    !
1603    !
1604    !
1605    !
1606    !
1607    !
1608    !
1609    !
1610    !
1611    !
1612    !
1613    !
1614    !
1615    !
1616    !
1617    !
1618    !
1619    !
1620    !
1621    !
1622    !
1623    !
1624    !
1625    !
1626    !
1627    !
1628    !
1629    !
1630    !
1631    !
1632    !
1633    !
1634    !
1635    !
1636    !
1637    !
1638    !
1639    !
1640    !
1641    !
1642    !
1643    !
1644    !
1645    !
1646    !
1647    !
1648    !
1649    !
1650    !
1651    !
1652    !
1653    !
1654    !
1655    !
1656    !
1657    !
1658    !
1659    !
1660    !
1661    !
1662    !
1663    !
1664    !
1665    !
1666    !
1667    !
1668    !
1669    !
1670    !
1671    !
1672    !
1673    !
1674    !
1675    !
1676    !
1677    !
1678    !
1679    !
1680    !
1681    !
1682    !
1683    !
1684    !
1685    !
1686    !
1687    !
1688    !
1689    !
1690    !
1691    !
1692    !
1693    !
1694    !
1695    !
1696    !
1697    !
1698    !
1699    !
1700    !
1701    !
1702    !
1703    !
1704    !
1705    !
1706    !
1707    !
1708    !
1709    !
1710    !
1711    !
1712    !
1713    !
1714    !
1715    !
1716    !
1717    !
1718    !
1719    !
1720    !
1721    !
1722    !
1723    !
1724    !
1725    !
1726    !
1727    !
1728    !
1729    !
1730    !
1731    !
1732    !
1733    !
1734    !
1735    !
1736    !
1737    !
1738    !
1739    !
1740    !
1741    !
1742    !
1743    !
1744    !
1745    !
1746    !
1747    !
1748    !
1749    !
1750    !
1751    !
1752    !
1753    !
1754    !
1755    !
1756    !
1757    !
1758    !
1759    !
1760    !
1761    !
1762    !
1763    !
1764    !
1765    !
1766    !
1767    !
1768    !
1769    !
1770    !
1771    !
1772    !
1773    !
1774    !
1775    !
1776    !
1777    !
1778    !
1779    !
1780    !
1781    !
1782    !
1783    !
1784    !
1785    !
1786    !
1787    !
1788    !
1789    !
1790    !
1791    !
1792    !
1793    !
1794    !
1795    !
1796    !
1797    !
1798    !
1799    !
1800    !
1801    !
1802    !
1803    !
1804    !
1805    !
1806    !
1807    !
1808    !
1809    !
1810    !
1811    !
1812    !
1813    !
1814    !
1815    !
1816    !
1817    !
1818    !
1819    !
1820    !
1821    !
1822    !
1823    !
1824    !
1825    !
1826    !
1827    !
1828    !
1829    !
1830    !
1831    !
1832    !
1833    !
1834    !
1835    !
1836    !
1837    !
1838    !
1839    !
1840    !
1841    !
1842    !
1843    !
1844    !
1845    !
1846    !
1847    !
1848    !
1849    !
1850    !
1851    !
1852    !
1853    !
1854    !
1855    !
1856    !
1857    !
1858    !
1859    !
1860    !
1861    !
1862    !
1863    !
1864    !
1865    !
1866    !
1867   
```

Line 90	Makes channel 1 the active channel, and measures the transmission parameter, S_{21} , displaying its magnitude in dB.
Lines 100 and 110	Inputs the center frequency and the frequency span.
Lines 120 and 130	Sets the center frequency and the frequency span to the HP 8751A.
Lines 150 through 180	Queries the center frequency and the frequency span.
Lines 190 and 200	Shows the current center frequency and the frequency span.

Performing a Measurement Calibration

This section will demonstrate how to coordinate a measurement calibration over HP-IB. The HP-IB program follows the key strokes required to calibrate from the front panel: there is a command for every step.

The general keystrokes sequence is to select the calibration, measure the calibration standards, and then declare the calibration done. The actual sequence depends on the calibration kit and changes slightly for 2-port calibrations, which are divided into three calibration sub-sequences.

Calibration Kits

The calibration kit tells the HP 8751A what standards to expect at each step of the calibration. The set of standards associated with a given calibration is termed a class. Refer to Appendix D for the relation between the calibration types and the standard classes.

For example, measuring the SHORT during a 1-port calibration is one calibration step. All of the SHORTs that can be used for this calibration step make up the class, which is called class $S_{11}B$. For the 7 mm calibration kits, class $S_{11}B$ has only one standard in it. For type-N calibration kits, class $S_{11}B$ has two standards in it: male and female SHORTs.

When doing a 1-port calibration in 7 mm over HP-IB, sending CLASS11B will automatically measure the SHORT. In type-N, sending CLASS11B brings up the menu with the male and female SHORT options. To select a standard, use STANA or STANB. The STAN command is appended with the letters A through G, corresponding to the standards list under softkeys 1 through 7, softkey 1 being the topmost softkey.

Each full 2-port calibration is divided into three sub-sequences: transmission, reflection, and isolation. Each sub-sequence is treated like a calibration in its own right; each must be opened, have all the standards measured, and then be declared done. The opening and closing statements for the transmission sub-sequence are TRAN and TRAD. The opening and closing statements for the reflection sub-sequence are REFL and REFD. The opening and closing statements for isolation are ISOL and ISOD.

Frequency Response Calibration

The following program does a response calibration using a THRU calibration device. This program simplifies the calibration for the operator by giving explicit directions on the computer's display.

```
10      !
20      ! Frequency Response Calibration
30      !
40      Hp8751=717
50      ABORT 7
60      CLEAR Hp8751
70      !
80      OUTPUT Hp8751;"PRES"
90      OUTPUT Hp8751;"CHAN1; S21; LOGM"
100     INPUT "Enter center frequency (Hz)",F_cent
110     INPUT "Enter frequency span (Hz)",F_span
120     OUTPUT Hp8751;"CENT ";F_cent
130     OUTPUT Hp8751;"SPAN ";F_span
140     !
150     OUTPUT Hp8751;"HOLD"
160     OUTPUT Hp8751;"CALKN50"
170     OUTPUT Hp8751;"CALIRESP"
180     INPUT "Connect THRU, then press [Return].",Dum$
190     OUTPUT Hp8751;"CLES"
200     OUTPUT Hp8751;"STANC"
210     REPEAT
220         OUTPUT Hp8751;"ESB?"
230         ENTER Hp8751;Stat
240     UNTIL BIT(Stat,0)
250     !
260     OUTPUT Hp8751;"RESPDONE"
270     OUTPUT Hp8751;"*OPC?"
280     ENTER Hp8751;Dum
290     OUTPUT Hp8751;"CONT"
300     DISP "Response cal completed."
310     END
```

Figure 2-4. Sample Program: Frequency Response Calibration

Line 150	Sets the trigger to the hold mode.
Line 160	Selects the 50 Ω type-N calibration kit.
Line 170	Opens the calibration by calling the response calibration.
Line 180	Asks for a THRU, and waits for the operator to connect it.
Line 190	Clears all registers.
Line 200	Selects and measures the THRU. There is more than one standard in this calibration, so we must identify the specific standard within this calibration. The THRU is the third softkey selection from the

top in the menu, so use the STANC command to select THRU as the standard.

- Lines 210 through 240 Waits for the standard to be measured. This is indicated by bit 0 of event status register B.
- Lines 260 through 280 Affirms the completion of the calibration, and waits for calculation completion.
- Line 290 Sets the trigger to the continuous mode.

1-Port Reflection Calibration

The following program does a 1-port calibration using the 50 Ω type-N calibration kit. The program assumes that the port being calibrated is a 50 Ω , type-N female test port. This program simplifies the calibration for the operator by giving explicit directions on the computer display.

```
10      !
11      !
12      ! 1-port Reflection Calibration
13      !
14      !
15      ! Hp8751=717
16      !
17      ! ABORT 7
18      !
19      ! CLEAR Hp8751
20      !
21      !
22      ! OUTPUT Hp8751;"PRES"
23      !
24      ! OUTPUT Hp8751;"CHAN1; S21; LOGM"
25      !
26      ! INPUT "Enter center frequency (Hz)",F_cent
27      !
28      ! INPUT "Enter frequency span (Hz)",F_span
29      !
30      ! OUTPUT Hp8751;"CENT ";F_cent
31      !
32      ! OUTPUT Hp8751;"SPAN ";F_span
33      !
34      !
35      ! OUTPUT Hp8751;"HOLD"
36      !
37      ! OUTPUT Hp8751;"CALKN50"
38      !
39      ! OUTPUT Hp8751;"CALIS111"
40      !
41      !
42      ! INPUT "Connect OPEN at port 1, then press [Return].",Dum$
43      !
44      ! OUTPUT Hp8751;"CLASS11A"
45      !
46      ! OUTPUT Hp8751;"CLES"
47      !
48      ! OUTPUT Hp8751;"STANB"
49      !
50      ! GOSUB Op_end
51      !
52      ! OUTPUT Hp8751;"DONE"
53      !
54      !
55      ! INPUT "Connect SHORT at port 1, then press [Return].",Dum$
56      !
57      ! OUTPUT Hp8751;"CLASS11B"
58      !
59      ! OUTPUT Hp8751;"CLES"
60      !
61      ! OUTPUT Hp8751;"STANB"
62      !
63      ! GOSUB Op_end
64      !
65      ! OUTPUT Hp8751;"DONE"
66      !
67      !
68      ! INPUT "Connect LOAD at port 1, then press [Return].",Dum$
69      !
70      ! OUTPUT Hp8751;"CLES"
71      !
72      ! OUTPUT Hp8751;"CLASS11C"
73      !
74      ! GOSUB Op_end
75      !
76      !
77      ! OUTPUT Hp8751;"SAV1"
78      !
79      ! OUTPUT Hp8751;"*OPC?"
80      !
81      ! ENTER Hp8751;Dum
82      !
83      ! OUTPUT Hp8751;"CONT"
84      !
85      ! DISP "1-port cal completed."
86      !
87      ! STOP
88      !
89      !
90      !
```

```

450 Op_end:
460   REPEAT
470     OUTPUT Hp8751;"ESB?"
480     ENTER Hp8751;Stat
490   UNTIL BIT(Stat,0)
500   RETURN
510   END

```

Figure 2-5. 1-port Reflection Calibration

Line 170	Opens the calibration by calling the S_{11} 1-port calibration.
Line 200	Selects the OPEN standard.
Line 210	Clears all the registers.
Line 220	Selects the female OPEN standard, and starts measuring the standard.
Line 230	Waits until the measurement ends.
Line 240	Completes the OPEN standard measurement.
Line 270	Selects the SHORT standard.
Line 290	Selects the female SHORT standard, and starts measuring the standard.
Line 310	Completes the SHORT standard measurement.
Line 350	Selects the LOAD standard, and starts measuring the standard.
Line 380	Saves the calibration.
Line 410	Sets the trigger to the continuous mode.
Line 450 through 500	Waits until the operation complete bit of the event status register is set to 0.

Data Transfer from the HP 8751A to a Computer

Trace information can be read out of the HP 8751A in several ways. Data can be read off the trace selectively using the markers, or the entire trace can be read out.

Using Markers to Obtain Trace Data at Specific Points

If only specific information such as a single point off the trace or the result of a marker search is needed, the marker output command can be used to read the information.

Marker data is read out with the command OUTPMARK. This command causes the HP 8751A to transmit three numbers: marker value 1, marker value 2, and marker stimulus value. Refer to Table 2-1 for all the different possibilities for values one and two.

```
10      !
11      !
12      !
13      !
14      !
15      !
16      !
17      !
18      !
19      !
20      ! Using Markers to Obtain trace data at specific points
21      !
22      !
23      !
24      !
25      !
26      !
27      !
28      !
29      !
30      !
31      !
32      !
33      !
34      !
35      !
36      !
37      !
38      !
39      !
40      Hp8751=717
41      !
42      !
43      !
44      !
45      !
46      !
47      !
48      !
49      !
50      ABORT 7
51      !
52      !
53      !
54      !
55      !
56      !
57      !
58      !
59      !
60      CLEAR Hp8751
61      !
62      !
63      !
64      !
65      !
66      !
67      !
68      !
69      !
70      !
71      !
72      !
73      !
74      !
75      !
76      !
77      !
78      !
79      !
80      OUTPUT Hp8751;"PRES"
81      !
82      !
83      !
84      !
85      !
86      !
87      !
88      !
89      !
90      OUTPUT Hp8751;"CHAN1; S21; LOGM"
91      !
92      !
93      !
94      !
95      !
96      !
97      !
98      !
99      !
100     INPUT "Enter center frequency (Hz)",F_cent
101     INPUT "Enter frequency span (Hz)",F_span
102     OUTPUT Hp8751;"CENT ";F_cent
103     OUTPUT Hp8751;"SPAN ";F_span
104     !
105     !
106     !
107     !
108     !
109     !
110     !
111     !
112     !
113     !
114     !
115     !
116     !
117     !
118     !
119     !
120     !
121     !
122     !
123     !
124     !
125     !
126     !
127     !
128     !
129     !
130     !
131     !
132     !
133     !
134     !
135     !
136     !
137     !
138     !
139     !
140     !
141     !
142     !
143     !
144     !
145     !
146     !
147     !
148     !
149     !
150     OUTPUT Hp8751;"CLES"
151     !
152     !
153     !
154     !
155     !
156     !
157     !
158     !
159     !
160     OUTPUT Hp8751;"SING"
161     !
162     !
163     !
164     !
165     !
166     !
167     !
168     !
169     !
170     REPEAT
171     !
172     !
173     !
174     !
175     !
176     !
177     !
178     !
179     !
180     OUTPUT Hp8751;"ESB?"
181     !
182     !
183     !
184     !
185     !
186     !
187     !
188     !
189     !
190     ENTER Hp8751;Stat
191     !
192     !
193     !
194     !
195     !
196     !
197     !
198     !
199     !
200     UNTIL BIT(Stat,0)
201     !
202     !
203     !
204     !
205     !
206     !
207     !
208     !
209     !
210     !
211     !
212     !
213     !
214     !
215     !
216     !
217     !
218     !
219     !
220     OUTPUT Hp8751;"AUTO"
221     !
222     !
223     !
224     !
225     !
226     !
227     !
228     !
229     !
230     OUTPUT Hp8751;"MARK1"
231     !
232     !
233     !
234     !
235     !
236     !
237     !
238     !
239     !
240     OUTPUT Hp8751;"SEAMIN"
241     !
242     !
243     !
244     !
245     !
246     !
247     !
248     !
249     !
250     OUTPUT Hp8751;"OUTPMARK?"
251     !
252     !
253     !
254     !
255     !
256     !
257     !
258     !
259     !
260     ENTER Hp8751;Val1,Val2,Stim
261     !
262     !
263     !
264     !
265     !
266     !
267     !
268     !
269     !
270     PRINT "Min val:",Val1;"dB"
271     !
272     !
273     !
274     !
275     !
276     !
277     !
278     !
279     !
280     PRINT "Stimulus:",Stim;"Hz"
281     !
282     !
283     !
284     !
285     !
286     !
287     !
288     !
289     !
290     END
```

Figure 2-6. Sample Program: Using Markers to Obtain Trace Data at Specific Points

- Lines 150 through 200 Collects one sweep of data, and wait for completion.
- Line 220 Brings the trace data in view on the HP 8751A's display.
- Line 230 Activates marker 1.

Line 240 Has the HP 8751A search for the trace minimum
 Line 250 Outputs the marker values at that point.
 Line 260 Reads marker value 1, marker value 2, and the stimulus value.

Table 2-1. Units as a Function of Display Format

Display Format	Marker Mode	OUTPMARK value 1, value 2	OUTPFOM value 1, value 2	Marker Readout ¹ value, aux value
LOG MAG		dB, ²	dB, ²	dB, ²
PHASE		degrees, ²	degrees, ²	degrees, ²
DELAY		seconds, ²	seconds, ²	seconds, ²
SMITH	LIN MKR	lin mag, degrees	real, imag	lin mag, degrees
CHART	LOG MKR	dB, degrees	real, imag	dB, degrees
	Re/Im	real, imag	real, imag	real, imag
	R + jX	real, imag ohms	real, imag	real, imag ohms
	G + jB	real, imag Siemens	real, imag	real, imag Siemens
POLAR	LIN MKR	lin mag, degrees	real, imag	lin mag, degrees
	LOG MKR	dB, degrees	real, imag	dB, degrees
	Re/Im	real, imag	real, imag	real, imag
LIN MAG		lin mag, ²	lin mag, ²	lin mag, ²
REAL		real, ²	real, ²	real, ²
SWR		SWR, ²	SWR, ²	SWR, ²

¹ The marker readout values are the marker values displayed in the upper left hand corner of the display. They also correspond to the value and aux value associated with the fixed marker.

² Value not significant in this form, but is included in data transfers.

Trace Transfer

Getting trace data out of the HP 8751A with a 200/300 series computer can be broken down into three steps:

1. Setting up the receive array.
2. Telling the HP 8751A to transmit the data.
3. Accepting the transferred data.

Data inside the HP 8751A is always stored in pairs, to accommodate real/imaginary values, for each data point. Therefore, the receiving array has to be two elements wide, and as deep as the number of points. This memory space for this array must be declared before any data is to be transferred from the HP 8751A to the computer.

Data Format. The HP 8751A can transmit data over HP-IB in four different formats. The type of format affects what kind of data array is declared (real or integer), since the format determines what type of data is transferred.

■ Form 2

IEEE 32-bit floating point format. In this mode, each number takes 4 bytes. This means that a 201-point transfer takes 1608 bytes. Figure 2-7 shows the data transfer format of Form 2.

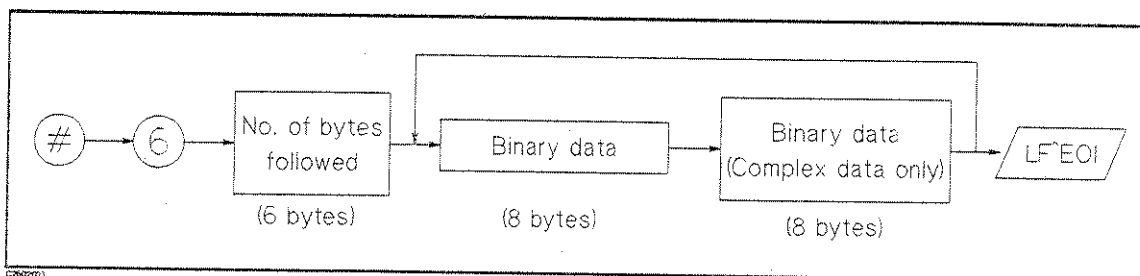

Figure 2-7. Form 2 Data Transfer Format

■ Form 3

IEEE 64-bit floating point format. In this mode, each number takes 8 bytes. This means that a 201-point transfer takes 3216 bytes. Data is stored internally in the 200/300 series computer with the IEEE 64-bit floating point format, eliminating the need for any reformatting by the computer. Figure 2-8 shows the data transfer format of Form 3.

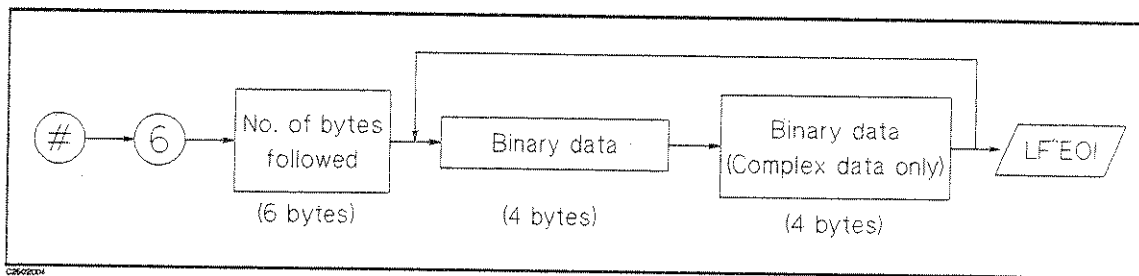

Figure 2-8. Form 3 Data Transfer Format

■ Form 4

ASCII data transfer format. In this mode, each number is sent as a 24 character string, each character being a digit, sign, or decimal point. Since there are two numbers per point, a 201-point transfer in Form 4 takes 9648 bytes.

■ Form 5

MS-DOS[®] personal computer format. This mode is a modification of IEEE 32-bit floating point format with the byte order reversed. Form 5 also has a four byte header which must be read in so that data order is maintained. In this mode, an MS-DOS[®] PC can store data internally without reformatting it.

Data Levels. Different levels of data can be read out of the HP 8751A (Refer to Figure 2-9).

■ Raw data

The basic measurement data, reflecting the stimulus parameters, IF averaging, and IF bandwidth. If a full 2-port measurement calibration is ON, there are four raw arrays kept: one for each raw S-parameter. The data is read out with the commands OUTPRAW{1-4}?. Normally, only raw 1 is available, and it holds the current parameter. If a 2-port calibration is ON the four arrays to S_{11} , S_{21} , S_{12} , and S_{22} respectively. This data is in real/imaginary pairs.

■ Error corrected data

This is the raw data with error correction applied. The array is for the currently measured parameter, and is in real/imaginary pairs. The error corrected data is read out with OUTPDATA? or OUTPDATAP?. OUTPMEMO? or OUTPMEMOP? reads the trace memory if available, which is also error corrected. Neither raw nor error corrected data reflect such post-processing functions as electrical delay offset, or trace math.

■ Unformatted data

This is the array of the complex number pairs which will be converted into a scalar number in the next stage. The unformatted data is read out with OUTPUFORM?.

■ Formatted data

This is the array of data being displayed. It reflects all post-processing functions such as electrical delay, and the units of the array read out depends on the current display format. Refer to Table 2-1 for various units as a function of display format. The formatted data is read out with OUTPFORM?, OUTPRFORM?, OUTPFORMP?, OUTPTMEM?, OUTPRTMEM?, OUTPTMEMP?, OUTPIFORM?, OUTPIRFORM?, OUTPITMEM? or OUTPIRTMEM?.

■ Calibration coefficients

The results of a calibration are arrays of calibration coefficients which are used in the error correction routines. Each array corresponds to a specific error term in the error model. The calibration coefficients are read out with OUTPCALC{01|12}?.

Formatted data is generally the most useful, being the same information seen on the display. However, if the post-processing is not necessary, as may be the case with smoothing, error corrected data is more desirable. Error corrected data also gives you the opportunity to load the data into the instrument and apply post-processing at a later time.

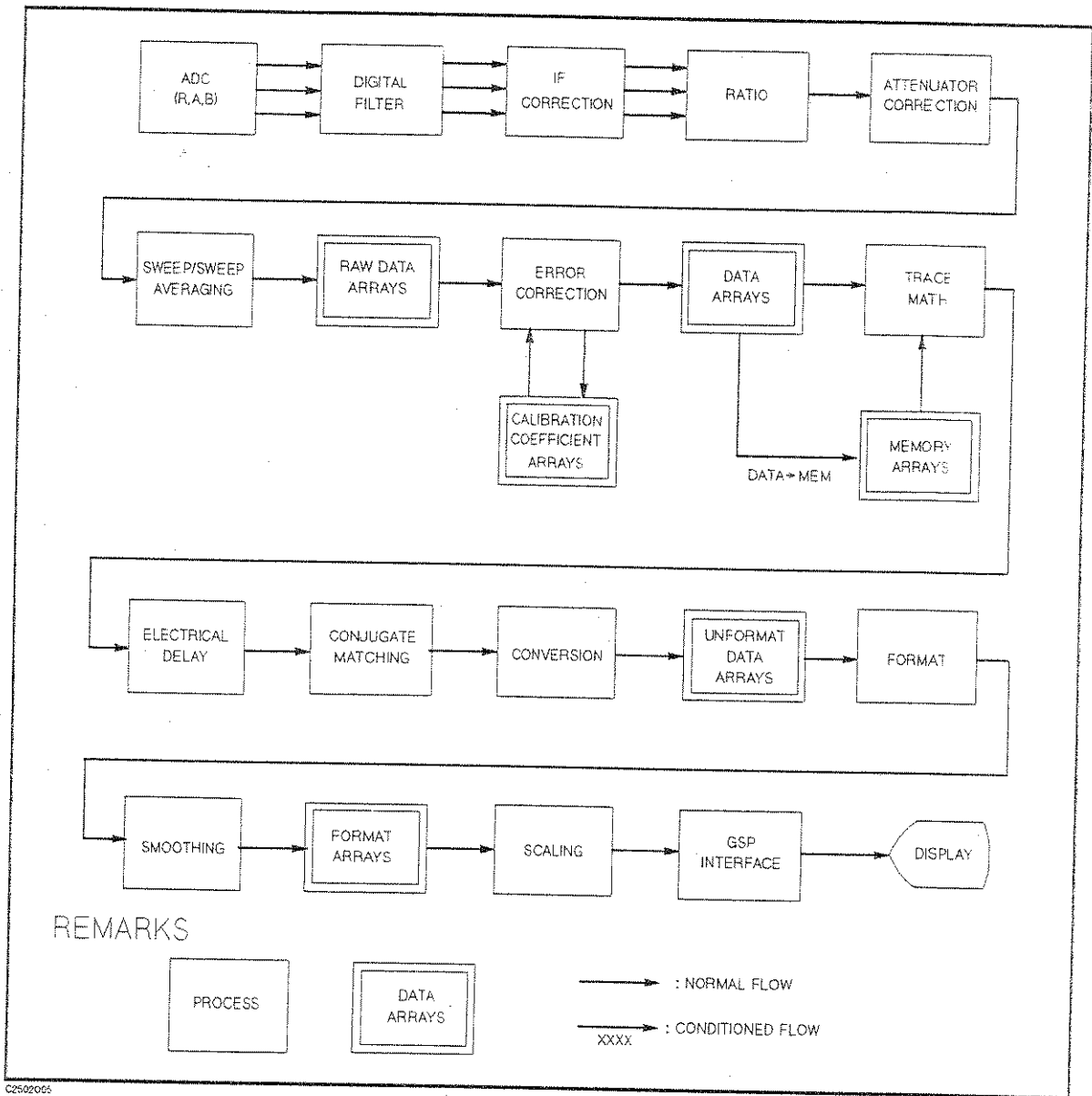

Figure 2-9. Data Processing Chain

Data Transfer Using ASCII Transfer Format (Form 4). When Form 4 is used, each number is sent as a 24 character string, each character being a digit, or decimal point. Since there are two numbers per point, a 201-point transfer in Form 4 takes 9648 bytes.

```
10      !
20      ! Data Transfer using ASCII Transfer Format
30      !
40      OPTION BASE 1
50      Hp8751=717
60      ABORT 7
70      CLEAR Hp8751
80      !
90      OUTPUT Hp8751;"PRES"
100     OUTPUT Hp8751;"CHAN1; S21; LOGM"
110     INPUT "Enter center frequency (Hz)",F_cent
120     INPUT "Enter frequency span (Hz)",F_span
130     OUTPUT Hp8751;"CENT ";F_cent
140     OUTPUT Hp8751;"SPAN ";F_span
150     !
160     OUTPUT Hp8751;"CLES"
170     OUTPUT Hp8751;"SING"
180     REPEAT
190         OUTPUT Hp8751;"ESB?"
200         ENTER Hp8751;Stat
210         UNTIL BIT(Stat,0)
220     !
230     OUTPUT Hp8751;"POIN?"
240     ENTER Hp8751;Nop
250     ALLOCATE Dat(Nop),Stim(Nop)
260     OUTPUT Hp8751;"FORM4"
270     !
280     OUTPUT Hp8751;"OUTPRFORM?"
290     ENTER Hp8751;Dat(*)
300     !
310     OUTPUT Hp8751;"OUTPSTIM?"
320     ENTER Hp8751;Stim(*)
330     !
340     FOR I=1 TO Nop
350         PRINT Stim(I);"Hz",Dat(I);"dB"
360     NEXT I
370     DEALLOCATE Dat(*),Stim(*)
380     END
```

Figure 2-10. Sample Program: Data Transfer using ASCII Transfer Format (Form 4)

- Line 40 Specifies the default lower bound of arrays to 1.
- Lines 230 and 240 Finds out how many points to expect.
- Line 250 Create arrays to hold the trace data and the stimulus data.

Line 260 Tells the HP 8751A to use the ASCII transfer format.
Line 280 Requests the real part of the formatted trace data.
Line 290 Transfers the data from the HP 8751A to the computer, and puts it
 in the receiving array.
Lines 310 and 320 Requests and transfers the stimulus data.
Line 370 Deallocates memory space.

Data Transfer using IEEE 64-bit Floating Point Format (Form 3). To use Form 3, the computer is told to stop formatting the incoming data with the ENTER statement. This is done by defining an I/O path with formatting OFF. Form 3 also has an eight-byte header to deal with. The first two bytes are the ASCII characters "#6" that indicate that a fixed length block transfer follows, and the next 6 bytes form an integer containing number of bytes in the block to follow. The header must be read in so that data order is maintained.

```

10      !
20      ! Data Transfer using IEEE 64-bit Floating Point Format
30      !
40      OPTION BASE 1
50      Hp8751=717
60      ABORT 7
70      CLEAR Hp8751
80      !
90      OUTPUT Hp8751;"PRES"
100     OUTPUT Hp8751;"CHAN1; S21; LOGM"
110     INPUT "Enter center frequency (Hz)",F_cent
120     INPUT "Enter frequency span (Hz)",F_span
130     OUTPUT Hp8751;"CENT ";F_cent
140     OUTPUT Hp8751;"SPAN ";F_span
150     !
160     OUTPUT Hp8751;"CLES"
170     OUTPUT Hp8751;"SING"
180     REPEAT
190         OUTPUT Hp8751;"ESB?"
200         ENTER Hp8751;Stat
210     UNTIL BIT(Stat,0)
220     !
230     OUTPUT Hp8751;"POIN?"
240     ENTER Hp8751;Nop
250     ALLOCATE Dat(Nop),Stim(Nop)
260     OUTPUT Hp8751;"FORM3"
270     ASSIGN @Dt TO Hp8751;FORMAT OFF
280     !
290     OUTPUT Hp8751;"OUTPRFORM?"
300     ENTER @Dt USING "#,8A";A$
310     ENTER @Dt;Dat(*)
320     ENTER @Dt USING "#,1A";B$
330     !
340     OUTPUT Hp8751;"OUTPSTIM?"
350     ENTER @Dt USING "#,8A";A$
360     ENTER @Dt;Stim(*)
370     ENTER @Dt USING "#,1A";B$
380     !
390     ASSIGN @Dt TO *
400     FOR I=1 TO Nop
410         PRINT Stim(I);"Hz",Dat(I);"dB"
420     NEXT I
430     DEALLOCATE Dat(*),Stim(*)

```

Figure 2-11. Sample Program: Data Transfer using IEEE 64-bit Floating Point Format (Form 3)

Line 260	Tells HP 8751A to output data using Form 3.
Line 270	Defines a data I/O path with ASCII formatting OFF. The I/O path points to the HP 8751A, and can be used to read or write data to the HP 8751A, as long as that data is in binary rather than ASCII format.
Line 300	Enters the header.
Line 310	Enters the data.
Line 320	Enters the terminator.
Line 390	Closes the I/O path.

Application Example

The following example is to measure the transmission parameter a bandpass filter and to get the typical parameters: -3 dB bandwidth, Center frequency, and Insertion loss.

```
10      !
20      ! Bandpass Filter Test
30      !
40      Hp8751=717
50      ABORT 7
60      CLEAR Hp8751
70      !
80      OUTPUT Hp8751;"PRES"
90      OUTPUT Hp8751;"CHAN1; S21; LOGM"
100     INPUT "Enter center frequency (Hz)",F_cent
110     INPUT "Enter frequency span (Hz)",F_span
120     OUTPUT Hp8751;"CENT ";F_cent
130     OUTPUT Hp8751;"SPAN ";F_span
140     !
150     OUTPUT Hp8751;"HOLD"
160     OUTPUT Hp8751;"CALKN50"
170     OUTPUT Hp8751;"CALIRESP"
180     INPUT "Connect THRU, then press [Return].",Dum$
190     OUTPUT Hp8751;"CLES"
200     OUTPUT Hp8751;"STANC"
210     GOSUB Op_end
220     OUTPUT Hp8751;"RESPDONE"
230     INPUT "Cal completed. Connect DUT, then press [Return].",Dum$
240     !
250     OUTPUT Hp8751;"CLES"
260     OUTPUT Hp8751;"SING"
270     GOSUB Op_end
280     !
290     OUTPUT Hp8751;"MARK1"
300     OUTPUT Hp8751;"SEAMAX"
310     OUTPUT Hp8751;"OUTPMARK?"
320     ENTER Hp8751;Loss,Val2,Stim
330     !
340     OUTPUT Hp8751;"DELR1"
350     OUTPUT Hp8751;"WIDV -3"
360     OUTPUT Hp8751;"WIDTON"
370     OUTPUT Hp8751;"OUTPMWID?"
380     ENTER Hp8751;Bw,Cent,Q
390     !
400     PRINT "-3 dB bandwidth:",Bw;"Hz"
410     PRINT "Center frequency:",Cent;"Hz"
420     PRINT "Insertion loss:",Loss;"dB"
430     STOP
440     !
450 Op_end: !
```

```
460 REPEAT
470     OUTPUT Hp8751;"ESB?"
480     ENTER Hp8751;Stat
490 UNTIL BIT(Stat,0)
500 RETURN
510 END
```

Figure 2-12. Sample Program: Application Example (Bandpass Filter Test)

Lines 80 through 130 Sets up measurement.
Lines 150 through 230 Does response calibration.
Lines 250 through 270 Takes one sweep of data.
Lines 290 through 320 Takes the insertion loss value using the marker search function.
Lines 340 through 380 Takes the -3 dB bandwidth value and the center frequency value using the bandwidth search function.

Advanced Programming Examples

Using List Frequency Mode

The list frequency mode lets you select the specific points or frequency spacing between points at which measurements are to be made. Sampling specific points reduces the measurement time since additional time is not spent measuring device characteristics at unnecessary frequencies.

This example shows how to create a list frequency table and transmit it to the HP 8751A. The command sequence for entering a list frequency table imitates the key sequence followed when entering a table from the front panel: there is a command for every key press. Editing a segment is also the same as the key sequence, but the HP 8751A automatically reorders each edited segment in order of increasing start frequency.

This example takes advantage of the computer's capabilities to simplify creating and editing the table. The table is entered and completely edited before being transmitted to the HP 8751A. To simplify the programming task, options such as entering step size are not included.

```
10      !
20      ! Using List Frequency Mode
30      !
40      OPTION BASE 1
50      Hp8751=717
60      ABORT 7
70      CLEAR Hp8751
80      !
90      INPUT "Enter number of segments",Numb
100     ALLOCATE Table(Numb,3)
110     !
120     PRINTER IS 1
130     OUTPUT 2;CHR$(255)&"K";
140     PRINT USING "10A,10A,10A,20A";"Segment","Start(Hz)","Stop(Hz)",
"Number of Points"
150     !
160     FOR I=1 TO Numb
170         GOSUB Loadpoin
180     NEXT I
190     !
200     LOOP
210     INPUT "Do you want to edit? (Y/N)",An$
220     EXIT IF An$="N" OR An$="n"
230     INPUT "Enter segment number",I
240     GOSUB Loadpoin
250     END LOOP
260     !
270     OUTPUT Hp8751;"PRES"
280     OUTPUT Hp8751;"CHAN1; S21; LOGM"
290     !
300     OUTPUT Hp8751;"EDITLIST"
310     OUTPUT Hp8751;"CLEL"
```

```

320   FOR I=1 TO Numb
330     OUTPUT Hp8751;"SADD"
340     OUTPUT Hp8751;"STAR ";Table(I,1)
350     OUTPUT Hp8751;"STOP ";Table(I,2)
360     OUTPUT Hp8751;"POIN ";Table(I,3)
370     OUTPUT Hp8751;"SDON"
380   NEXT I
390   OUTPUT Hp8751;"EDITDONE"
400   OUTPUT Hp8751;"LISFREQ"
410   OUTPUT Hp8751;"LISDOBASE"
420   !
430   OUTPUT Hp8751;"CLES"
440   OUTPUT Hp8751;"SING"
450   REPEAT
460     OUTPUT Hp8751;"ESB?"
470     ENTER Hp8751;Stat
480   UNTIL BIT(Stat,0)
490   OUTPUT Hp8751;"AUTO"
500   STOP
510   !
520 Loadpoin:  !
530   INPUT "Enter start frequency (Hz)",Table(I,1)
540   INPUT "Enter stop frequency (Hz)",Table(I,2)
550   INPUT "Enter number of points",Table(I,3)
560   IF Table(I,3)=1 THEN Table(I,2)=Table(I,1)
570   PRINT TABXY(0,I+1);I;TAB(10);Table(I,1);TAB(20);Table(I,2);TAB(35);
Table(I,3)
580   RETURN
590   END

```

Figure 2-13. Sample Program: Using List Frequency Mode

Line 90	Finds out how many segments to expect.
Line 100	Creates a table to hold the segments. Keeps start frequency, stop frequency, and number of points.
Lines 120 through 140	Clears the screen and print the table header.
Lines 160 through 180	Reads in each segment.
Lines 200 through 250	Edits the table until editing is no longer needed.
Line 300	Activates the frequency list edit mode, and opens the list frequency table for editing.
Line 310	Deletes any existing segments.
Lines 320 through 380	Enters the segment values.
Line 390	Closes the table.
Line 400	Turns on list frequency mode.
Line 410	Displays the trace for only the listed frequency ranges.

Lines 520 through 580 Enters in a segment.
Lines 530 through 550 Enters the segment values.
Line 560 Makes the stop frequency equal to the start frequency to avoid ambiguity, if only one point is in the segment.
Line 570 Prints the segment out.

Using Limit Lines to Perform Limit Testing

This example shows how to create a limit table and transmit it to the HP 8751A. The command sequence for entering a limit table imitates the key sequence followed when entering a table from the front panel: there is a command for every key press. Editing a limit is also the same as the key sequence, but remember that the HP 8751A automatically reorders the table in order of increasing start frequency.

This example takes advantage of the computer's capabilities to simplify creating and editing the table. The table is entered and completely edited before being transmitted to the HP 8751A. To simplify the programming task, options such as entering offsets are not included.

```
10      !
20      ! Setting up Limit Lines
30      !
40      OPTION BASE 1
50      Hp8751=717
60      ABORT 7
70      CLEAR Hp8751
80      !
90      OUTPUT Hp8751;"PRES"
100     OUTPUT Hp8751;"CHAN1; S21; LOGM"
110     INPUT "Enter start frequency (Hz)",F_start
120     INPUT "Enter stop frequency (Hz)",F_stop
130     OUTPUT Hp8751;"STAR ";F_start
140     OUTPUT Hp8751;"STOP ";F_stop
150     !
160     INPUT "Enter number of limits",Numb
170     ALLOCATE Table(Numb,3)
180     !
190     PRINTER IS 1
200     OUTPUT 2;CHR$(255)&"K";
210     PRINT USING "10A,15A,15A,15A";"Segment","Stimulus(Hz)","Upper(dB)",
"Lower(dB)"
220     !
230     FOR I=1 TO Numb
240         GOSUB Loadlimit
250     NEXT I
260     !
270     LOOP
280         INPUT "Do you want to edit? (Y/N)",An$
290         EXIT IF An$="N" OR An$="n"
300         INPUT "Enter segment number",I
310         GOSUB Loadlimit
320     END LOOP
330     !
340     OUTPUT Hp8751;"EDITLIML"
350     OUTPUT Hp8751;"LIMCLEL"
360     FOR I=1 TO Numb
370         OUTPUT Hp8751;"LIMSADD"
380         OUTPUT Hp8751;"LIMS ";Table(I,1)
```

```

390     OUTPUT Hp8751;"LIMU ";Table(I,2)
400     OUTPUT Hp8751;"LIML ";Table(I,3)
410     OUTPUT Hp8751;"LIMSDON"
420     NEXT I
430     !
440     OUTPUT Hp8751;"LIMEDONE"
450     OUTPUT Hp8751;"LIMILINEON"
460     OUTPUT Hp8751;"LIMITESTON"
470     DEALLOCATE Table(*)
480     STOP
490     !
500     Loadlimit: !
510     INPUT "Enter stimulus value (Hz)",Table(I,1)
520     INPUT "Enter upper limit value (dB)",Table(I,2)
530     INPUT "Enter lower limit value (dB)",Table(I,3)
540     PRINT TABXY(0,I+1);I;TAB(11);Table(I,1);TAB(27);Table(I,2);TAB(42);
Table(I,3)
550     RETURN
560     END

```

Figure 2-14. Sample Program: Setting up Limit Lines

Line 160	Finds out how many limits to expect.
Line 170	Creates a table to hold the limits. It will contain the stimulus value (frequency), the upper limit value, and the lower limit value.
Lines 190 through 210	Clears the screen and prints the table header.
Lines 230 through 250	Reads in each segment.
Lines 270 through 320	Edits the table until editing is no longer needed.
Line 340	Begins editing the limit line table.
Line 350	Deletes any existing limits.
Lines 360 through 420	Enters the segment values.
Line 440	Closes the table.
Line 450	Displays the limits.
Line 460	Activates the limit testing.
Lines 500 through 550	Enters a segment.

Storing and Recalling Instrument Status

This example demonstrates ways of storing and recalling entire instrument states over HP-IB.

Coordinating disk storage

This example shows how to save and recall the instrument status in the disk installed in the built-in disk drive.

```
10      !
20      ! Storing Instrument States
30      !
40      DIM Err$(50)
50      Hp8751=717
60      ABORT 7
70      CLEAR Hp8751
80      !
90      OUTPUT Hp8751;"PRES"
100     OUTPUT Hp8751;"CHAN1; S21; LOGM"
110     INPUT "Enter center frequency (Hz)",F_cent
120     INPUT "Enter frequency span (Hz)",F_span
130     OUTPUT Hp8751;"CENT ";F_cent
140     OUTPUT Hp8751;"SPAN ";F_span
150     !
160     INPUT "File name? (up to 8 char.)",Name$
170     OUTPUT Hp8751;"SAVDSTA """;Name$;"";"
180     OUTPUT Hp8751;"*OPC?"
190     ENTER Hp8751;Dum
200     OUTPUT Hp8751;"OUTPERRO?"
210     ENTER Hp8751;Err,Err$
220     IF Err THEN
230         PRINT "Error occurred."
240         PRINT Err$
250         STOP
260     ELSE
270         INPUT "Save done. Press [Return] to recall.",Dum$
280     END IF
290     !
300     OUTPUT Hp8751;"PRES"
310     OUTPUT Hp8751;"RECD """;Name$;"_S"";"
320     OUTPUT Hp8751;"*OPC?"
330     ENTER Hp8751;Dum
340     DISP "Done."
350     END
```

Figure 2-15. Sample Program: Storing Instrument States

Line 160 Gets the name of the file to create.

Line 170 Saves the instrument states and the calibration coefficients with the file name. The file name must be preceded and followed by double

quotation marks, and the only way to do that with an OUTPUT statement is to use two sets of quotation marks: "".

- Lines 180 and 190 Waits for completion of the saving.
- Lines 200 and 210 Examines whether an error occurred or not.
- Lines 220 through 280 If an error is detected, prints the error number and the error message.
If an error is not detected, prompts the user to continue the program.
- Line 310 Adds the extension to the file name and recalls the file.

Reading Calibration Data

This example demonstrates how to read measurement calibration data out of the HP 8751A, and how to put it back into the HP 8751A.

The data used to perform measurement error correction is stored inside the HP 8751A in up to twelve calibration coefficient arrays. Each array is a specific error coefficient, and is stored and transmitted as an error corrected data array: each point is a real/imaginary pair, and the number of points in the array is the same as the number of points in the sweep. The four data format also apply to the transfer of calibration coefficient arrays. Appendix D specifies where the calibration coefficients are stored for different calibration types.

A computer can read out the error coefficients using the OUTPCALC{01-12} commands. Each calibration type uses only as many arrays as needed, starting with array 1. Therefore, it is necessary to know the type of calibration about to be read out: attempting to read an array not being used in the current calibration causes the "REQUESTED DATA NOT CURRENTLY AVAILABLE" warning.

A computer can also store calibration coefficients in the HP 8751A. To do this, declare the type of calibration data about to be stored in the HP 8751A just as if you were about to perform that calibration. Then, instead of calling up different classes, transfer the calibration coefficients using the INPUCALC{01-12} commands. When all the coefficients are in the HP 8751A, activate the calibration by issuing the mnemonic SAVC, and have the HP 8751A take a sweep.

This example reads the response calibration coefficients into a very large array, from which they can be examined, modified, stored, or put back into the HP 8751A.

```
10  !
20  ! Reading calibration data
30  !
40  OPTION BASE 1
50  DIM Head$(6)
60  Hp8751=717
70  ABORT 7
80  CLEAR Hp8751
90  !
100 INPUT "Connect THRU and press [Return] to do cal.",Dum$
110 GOSUB Setup
120 GOSUB Cal
130 OUTPUT Hp8751;"SAVC"
140 OUTPUT Hp8751;"POIN?"
150 ENTER Hp8751;Nop
160 ALLOCATE Dat(Nop,2)
170 !
180 INPUT "Press [Return] to transmit cal data.",Dum$
190 ASSIGN @Dt TO Hp8751;FORMAT OFF
200 OUTPUT Hp8751;"FORM3"
210 OUTPUT Hp8751;"OUTPCALC01?"
220 ENTER @Dt USING "#,8A";A$
230 ENTER @Dt;Dat(*)
240 ENTER @Dt USING "#,1A";B$
250 INPUT "Transmit done. Disconnect THRU and press [Return].",Dum$
```

```

260 !
270 GOSUB Setup
280 GOSUB Cal
290 OUTPUT Hp8751;"SAVC"
300 !
310 INPUT "Press [Return] to retransmit cal data.",Dum$
320 V$=VAL$(Nop*2*8)
330 Numv=LEN(V$)
340 Head$="000000"
350 FOR I=1 TO Numv
360   Head$[7-I,7-I]=V$[Numv-I+1,Numv-I+1]
370 NEXT I
380 !
390 OUTPUT Hp8751;"INPUCALCO1 ";
400 OUTPUT Hp8751;"#6"&Head$
410 OUTPUT @Dt;Dat(*),END
420 OUTPUT Hp8751;"SAVC"
430 !
440 ASSIGN @Dt TO *
450 DEALLOCATE Dat(*)
460 DISP "Retransmit completed. Connect DUT."
470 OUTPUT Hp8751;"CONT"
480 STOP
490 !
500 Setup: !
510   F_cent=7.0E+7
520   F_span=2.0E+5
530   OUTPUT Hp8751;"PRES"
540   OUTPUT Hp8751;"CHAN1; S21; LOGM"
550   OUTPUT Hp8751;"CENT ";F_cent
560   OUTPUT Hp8751;"SPAN ";F_span
570   OUTPUT Hp8751;"SING"
580   RETURN
590   !
600 Cal: !
610   OUTPUT Hp8751;"CALIRESP"
620   OUTPUT Hp8751;"CLES"
630   OUTPUT Hp8751;"STANC"
640   REPEAT
650     OUTPUT Hp8751;"ESB?"
660     ENTER Hp8751;Stat
670     UNTIL BIT(Stat,0)
680     WAIT .001
690     OUTPUT Hp8751;"RESPDONE"
700     RETURN
710   END

```

Figure 2-16. Reading calibration data

Line 50 Declares the dimension part of the file header.

Line 110	Presets and sets up the HP 8751A, then holds the trigger.
Line 120	Performs the response calibration.
Line 130	Re-draws the trace with the calibration data.
Line 210	Requests outputting the calibration data.
Line 220	Enters the file header.
Line 230	Enters the calibration data.
Line 240	Enters the file terminator.
Line 280	Performs the calibration to set the correction ON.
Line 320	Calculates the number of bytes transferred, and represents it in the string format.
Line 330	Counts the number of characters in the string which contains the number of bytes transferred.
Line 340	Enters 0 to all the arrays of the header as the initial value.
Line 350 through 370	Places the number of bytes transferred to the header array digit by digit from the sixth array to the first array of the header.
Line 390 through 410	Transmits the file header and calibration data.

Miscellaneous Programming Examples

Controlling Peripherals

The purpose of this section is to demonstrate how to coordinate printers or plotters with the HP 8751A.

The HP 8751A has two operating modes with respect to HP-IB, as set under the LOCAL menu: System controller mode and Addressable only mode. The system controller mode is used when no controller is present. The addressable only mode is how the computer can control the HP 8751A and how the computer can pass active control to the HP 8751A so that the HP 8751A can plot or print.

Note that the HP 8751A assumes that the address of the computer is correctly stored in its HP-IB addresses menu under the ADDRESS: CONTROLLER entry. If this address is incorrect, control will not return to the computer.

If the HP 8751A is in Addressable only mode and receives a command telling it to plot or print, it sets bit 1 in the event status register to indicate that it needs control of the bus. If the computer then uses the HP-IB control command to pass control to the HP 8751A, the HP 8751A will take control of the bus, and access the peripheral. When the HP 8751A no longer needs control, it will pass it back to the computer.

Control should not be passed to the HP 8751A before it has set event status register bit 1, Request Active Control. If the HP 8751A receives control before the bit is set, control is passed immediately back.

While the HP 8751A has control, it is free to address devices to talk and listen as needed. The only functions denied it are the ability to assert the interface clear line (IFC), and remote line (REN). These are reserved for the system controller. As active controller, the HP 8751A can send messages to and read replies back from printers and plotters.

This example prints the display.

```
10      !
20      ! Controlling Peripherals
30      !
40      DIM Err$(50)
50      Hp8751=717
60      !
70      OUTPUT Hp8751;"*CLS"
80      OUTPUT Hp8751;"*ESE 2"
90      !
100     OUTPUT Hp8751;"PRINALL"
110     REPEAT
120         Stat=SPOLL(Hp8751)
130     UNTIL BIT(Stat,5)
140     !
150     PASS CONTROL Hp8751
160     DISP "Printing."
170     REPEAT
180         STATUS 7,6;Hpib
```



```

190 UNTIL BIT(Hpib,6)
200 DISP "Done."
210 !
220 OUTPUT Hp8751;"OUTPERRO?"
230 ENTER Hp8751;Err,Err$
240 IF Err THEN DISP Err$
250 END

```

Figure 2-17. Sample Program: Controlling Peripherals

Line 70	Clears the status reporting system.
Line 80	Enables the Request Active Control bit in the event status register.
Line 100	Requests printing.
Lines 110 through 130	Waits until the HP 8751A requests control.
Line 150	Passes active control to the HP 8751A.
Line 170 through 190	Waits until the print is finished and the control is returned.
Line 220 through 240	If an error occurred, prints the error number and the error message.

Transferring disk data files

The built-in disk drive is often used to store data files in addition to instrument states. The file name is then appended with two characters to indicate what is in the file. "_D" indicates the file contains the internal data array using the `SAVE DATA ONLY` or the `SAVDDAT` command. Refer to "Saving and Recalling Instrument States and Data" in the *Reference Manual* for the file structure.

This example demonstrates how to recall a data file stored by the built-in disk drive into a computer using the disk drive connected to the computer.

Before running the program, store the data to the disk installed in the built-in disk drive, remove the disk, and put the disk in the disk drive connected to the computer.

```
10      !
20      ! Transferring Disk Data Files
30      !
40      OPTION BASE 1
50      INTEGER Nop
60      DIM Sw$(7)[8],Numseg(7)
70      DATA "Raw",8,"Cal",24,"Data",2,"Mem",2,"Unform",2,"Trace",2,
"Tracemem",2
80      !
90      INPUT "File name (with extension)?",File$
100     ASSIGN @Path TO File$
110     ENTER @Path USING "6X,#"
120     Numdat=0
130     PRINT "Data contained:"
140     FOR I=1 TO 7
150         READ Dat$,Num
160         GOSUB Datasw
170     NEXT I
180     PRINT
190     ENTER @Path USING "4X,#"
200     !
210     INPUT "Press [Return] to read data.",Dum$
220     FOR J=1 TO Numdat
230         FOR I=1 TO Numseg(J)
240             PRINT Sw$(J);I
250             GOSUB Dataseg
260             PRINT
270         NEXT I
280         PRINT
290         IF J<>Numdat THEN INPUT "Press [Return] to read next data.",Dum$
300     NEXT J
310     ASSIGN @Path TO *
320     STOP
330     !
340 Datasw: !
350     ENTER @Path USING "B,#";Sw
360     IF Sw THEN
```

```

370     Numdat=Numdat+1
380     Sw$(Numdat)=Dat$
390     Numseg(Numdat)=Num
400     PRINT Sw$(Numdat)
410 END IF
420 RETURN
430 !
440 Dataseg: !
450 ENTER @Path;Nop
460 ENTER @Path USING "4X,#"
470 FOR K=1 TO Nop
480     ENTER @Path;X,Y
490     PRINT Nop,X,Y
500 NEXT K
510 ENTER @Path USING "4X,#"
520 RETURN
530 END

```

Figure 2-18. Sample Program: Transferring Disk Data Files

Lines 50 and 60	Sets up the data of possible data groups.
Line 90	Gets the file name to load. The file name must be included the extension: "_D".
Line 100	Defines an I/O path which points to the chosen file.
Line 110	Enters bytes of internal use only.
Line 120 through 170	Reads the data switches and examine the data contained.
Line 190	Enters bytes of internal use only.
Line 220 through 300	Enters a data group.
Line 230 through 270	Enters a data segment.
Line 310	Closes the I/O path.
Lines 340 through 420	Reads a data switch.
Lines 440 through 520	Enters a data segment.
Line 450	Enters the number of data bytes which follow.
Line 460	Enters bytes of internal use only.
Lines 470 through 500	Reads the data.
Line 510	Enters the bytes of internal use only.

Status Reporting

The HP 8751A has a status reporting mechanism that gives information about specific functions and events inside the HP 8751A. The status byte is an 8-bit register with each bit summarizing the state of one aspect of the HP 8751A. For example, the error queue summary bit will always be set if there are any errors in the queue. The value of the status byte can be read with the SPOLL statement. This command does not automatically put the HP 8751A into the remote mode, thus giving the operator access to the HP 8751A front panel functions. Reading the status byte does not affect its value. The sequencing bit can be set by the operator during execution of a test sequence.

The status byte also summarizes two event status registers and one operational status register that monitor specific conditions inside the HP 8751A. The status byte also has a bit that is set when the HP 8751A is issuing a service request over HP-IB, and a bit that is set when the HP 8751A has data to send out over HP-IB. Refer to Appendix B for a definition of the status registers.

The error queue holds up to 20 instrument errors and warnings in the order that they occurred. Each time the HP 8751A detects an error condition and displays a message on the CRT, it also puts the error in the error queue. If there are any errors in the queue, bit 3 of the status byte will be set. The errors can be read from the queue with the OUTPERRO? command, which causes the HP 8751A to transmit the error number and the error message of the oldest error in the queue.

It is also possible to generate interrupts using the status reporting mechanism. The status byte bits can be enabled to generate a service request (SRQ) when set. The computers can in turn be set up to generate an interrupt on the SRQ.

To be able to generate an SRQ, a bit in the status byte has to be enabled using *SRE *n*. A one in a bit position enables that bit in the status byte. Therefore, *SRE 8 enables an SRQ on bit 3, check error queue, since 8 equals 00001000 in binary representation. That means that whenever an error is put into the error queue and bit 3 gets set, and the SRQ line is asserted. The only way to clear the SRQ is to disable bit 3, re-enable bit 3, or read out all the errors from the queue.

A bit in the event status register can be enabled so that it is summarized by bit 5 of the status byte. If any bit is enabled in the event status register, bit 5 of the status byte will also be set. For example, *ESE 66 enables bits 1 and 6 of the event status register, since 66 equals 01000010 in binary representation. Therefore, whenever active control is requested or a front panel key is pressed, bit 5 of the status byte will be set. Similarly, ESNB *n* enables bits in event status register B so that they will be summarized by bit 2 in the status byte.

To generate an SRQ from an event status register, enable the desired event status register bit. Then enable the status byte to generate an SRQ. For instance, *ESE 32 and *SRE 32 enable the syntax error bit, so that when the syntax error bit is set, the summary bit in the status byte will be set, and it enables an SRQ on bit 5 of the status byte.

```
10      !
20      ! Generating Interrupts
30      !
40      Hp8751=717
50      !
60      OUTPUT Hp8751;"*CLS"
```

```

70  OUTPUT Hp8751;"*ESE 32"
80  OUTPUT Hp8751;"*SRE 32"
90  !
100 ON INTR 7 GOSUB Err_report
110 ENABLE INTR 7;2
120 !
130 LOOP
140 END LOOP
150 STOP
160 !
170 Err_report:
180 Stat=SPOLL(Hp8751)
190 OUTPUT Hp8751;"*ESR?"
200 ENTER Hp8751;Estat
210 PRINT "Syntax error detected."
220 !
230 OUTPUT Hp8751;"OUTPERRO?"
240 ENTER Hp8751;Err,Err$
250 PRINT Err,Err$
260 !
270 ENABLE INTR 7
280 RETURN
290 END

```

Figure 2-19. Sample Program: Generating interrupts

Line 60	Clears the status reporting system.
Line 70	Enables bit 5 of the event status register.
Line 80	Enables bit 5 of the status byte so that an SRQ will generated on a syntax error.
Line 100	Tells the computer where to branch it gets the interrupt.
Line 110	Tells the computer to enable an interrupt from interface 7 (HP-IB) when value 2 (bit 1: SRQ bit) of the interrupt register is set. A branch to Err_report will disable the interrupt, so the return from Err_report re-enables it. If there is more than one instrument on the bus capable of generating an SRQ, it is necessary to use serial poll to determine which device has issued the SRQ. In this case, we assume the HP 8751A did it. A branch to Err_report will disable the interrupt, so the return from Err_report re-enable it.
Line 130 and 140	Does nothing loop.
Line 180	Clears the SRQ bit of the status byte.
Lines 190 and 200	Reads the register to clear the bit.
Lines 230 through 250	Instructs the HP 8751A to output the error number and the error message, and print them.

HP-IB Programming Reference

This chapter provides a reference for the HP-IB operation of the HP 8751A. Use this information as a reference to the syntax requirements and general function of the individual commands.

This chapter lists the commands in alphabetical order. Refer to Appendix A for a functional list of the commands.

Refer to the *Reference Manual* for the details of each function, or to the *Service Manual* for detail of the service related functions.

Notation

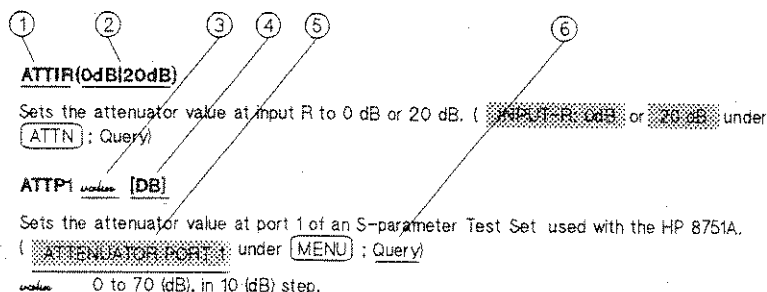

- ① Upper case bold characters represent the program codes which must appear exactly as shown with no embedded spaces. Upper and lower case characters are equivalent.
- ② Characters enclosed in the { } brackets are qualifiers attached to the root mnemonic. There can be no spaces or symbols between the root mnemonic and its appendage.

For example:

{ON|OFF} shows that either ON or OFF can be attached to the root mnemonic.
 CONM{ON|OFF} means CONMON or CONMOFF.

{1-4} shows that the numeral 1, 2, 3, or 4 can be attached to the root mnemonic.
 DELR{1-4} means DELR1, DELR2, DELR3, or DELR4.

- ③ A constant or a pre-assigned simple or complex numeric or string variable transferred to the HP 8751A. There must be a space between it and the code.
- ④ Square brackets indicate that the enclosed information is optional.
- ⑤ Softkey or hardkey which has the same function.

⑥ “Query” indicates that the command can be queried. Refer to “Query Commands”.

Note



A semicolon (;) is required as a separator for each program command except for the last command.

For example, either of the followings is acceptable.

```
OUTPUT Hp8751;"CHAN1; S11; LOGM;"
OUTPUT Hp8751;"CHAN1; S11; LOGM"
```

Query Commands

All instrument function can be interrogated to find the current On/Off state or value.

For instrument state commands, append the question mark (?) character instead of {ON|OFF} to interrogate the state of the functions. The HP 8751A responds to the next controller ENTER operation with a “1” or a “0” to indicate On or Off, respectively.

For settable functions such as SCAL *value*, using SCAL? causes the HP 8751A to respond to the next controller ENTER operation by outputting the current function value then clearing the instrument entry area.

If a command that does not have a defined response is interrogated, the instrument outputs a zero.

■ Example 1

AB

```
OUTPUT Hp8751;"AB?;"
ENTER Hp8751;Reply
PRINT "Input port is AB?",
IF Reply then PRINT "Yes"
IF NOT Reply the PRINT "No"
```

■ Example 2

ATTIA{0DB|20DB}

```
OUTPUT Hp8751;"ATTIA?;"
ENTER Hp8751;Reply$
PRINT "Port A attenuator value is ";Reply$
```

■ Example 3

ADDRCONT *value*

```
OUTPUT Hp8751;"ADDRCONT?;"
ENTER Hp8751;Reply
PRINT "Controller HP-IB address is ";Reply
```

Suffix

The following suffixes can be used as the units the of stimulus values:

Frequency:	Hz (default), MHz
Power:	dBm (default)
Attenuator:	dB (default)
Log mag:	dB (default)
Delay time:	s (default)
Phase:	deg (default)
Capacitance:	F (default)
Inductance:	H (default)
Impedance:	ohm (default)

If no suffix is used, the HP 8751A assumes the default values for the instruction. Upper and lower case characters are equivalent.

Code Naming Conventions

The HP-IB Commands of HP 8751A are derived from their front panel key titles (where possible), according to the naming conventions below.

Some codes require appendages (on, off, 1, 2, etc.). Codes that have no front panel equivalent are HP-IB only commands, and use a similar convention based on the common name of the function. Where possible, HP 8751A codes are compatible with HP 8753 and HP 8510 codes.

Table 3-1. HP-IB Code Naming Convention

Convention	For HP-IB Code Use	Example	
		Key Title	HP-IB Code
One word	First four letters	POWER START	POWE STAR
Two words	First three letters of first word and first letter of second word	ELECTRICAL DELAY SEARCH RIGHT	ELED SEAR
Two words in a group	First four letters of both	MARKER — CENTER	MARKCENT
Three Words	First three letters of first word, first letter of second word, and first four letters of third word	CAL KIT: 7mm SEARCH RNG STORE	CALK7MM SEARSTOR

Reference

AB

Calculates and displays the complex ratio of input A to input B. (**A/B** under **MEAS**; Query)

ABODCALI

Aborts the dc detector's output voltage linearity calibration. (**ABORT DC CAL** under **CAL**)

ACTLHFRE

Sets the active L high frequency. (Under **SERVICE MENU** under **SYSTEM**; Query)

ACTLLFRE

Sets the active L low frequency. (Under **SERVICE MENU** under **SYSTEM**; Query)

ACTLNORM

Sets the active L normal. (Under **SERVICE MENU** under **SYSTEM**; Query)

ADDRCONT *value*

Sets the HP-IB address which the HP 8751A will use to communicate with an external controller. (**ADDRESS: CONTROLLER** under **LOCAL**; Query)

value 0 to 30.

ADDRPLOT *value*

Sets the HP-IB address which the HP 8751A will use to communicate with the plotter. (**ADDRESS: PLOTTER** under **LOCAL**; Query)

value 0 to 30.

ADDRPRIN *value*

Sets the HP-IB address which the HP 8751A will use to communicate with the printer. (**ADDRESS: PRINTER** under **LOCAL**; Query)

value 0 to 30.

AR

Calculates and displays the complex ratio of input A to input R. (**A/R** under **MEAS**); Query)

ATTIA{0DB|20DB}

Sets the attenuator value at input A to 0 dB or 20 dB. (**INPUT-A: 0dB** or **20dB** under **ATTEN**); Query)

ATTIB{0DB|20DB}

Sets the attenuator value at input B to 0 dB or 20 dB. (**INPUT-B: 0dB** or **20dB** under **ATTEN**); Query)

ATTIR{0dB|20dB}

Sets the attenuator value at input R to 0 dB or 20 dB. (**INPUT-R: 0dB** or **20dB** under **ATTEN**); Query)

ATTP1 value [dB]

Sets the attenuator value at port 1 of an S-parameter test set used with the HP 8751A. (**ATTENUATOR PORT 1** under **MENU**); Query)

value 0 to 70 (dB), in 10 (dB) step.

ATTP2 value [dB]

Sets the attenuator value at port 2 of an S-parameter test set used with the HP 8751A. (**ATTENUATOR PORT 2** under **MENU**); Query)

value 0 to 70 (dB), in 10 (dB) step.

AUTO

Selects the scale/div value automatically to fit the trace data to the display. (**AUTO SCALE** under **SCALE REF**)

AVERFACT value

Sets the averaging factor. (**AVERAGING FACTOR** under **AVG**); Query)

value 1 to 999.

AVER{ON|OFF}

Sets the averaging function on or off for the active channel. (**AVERAGING on off** under **AVG**; Query)

AVERREST

Resets and restarts averaging. (**AVERAGING RESTART** under **AVG**)

BACI value

Sets the background intensity of the display as a percent of the white level. (**BACKGROUND INTENSITY** under **DISPLAY**; Query)

value 0 to 100 (%).

BDC

Displays a dc voltage at input B. (**Bdc** under **MEAS**; Query)

BDCR

Calculates and displays the ratio of a dc voltage at input B to the reference signal at input R. (**Bdc/R** under **MENU**; Query)

BEEPDONE{ON|OFF}

Sets the operation completion beeper on or off. (**BEEP DONE on off** under **DISPLAY**; Query)

BEEPFAIL{ON|OFF}

Sets the limit fail beeper on or off. (**BEEP FAIL on off** under **SYSTEM**; Query)

BEEPWARN{ON|OFF}

Sets the warning beeper on or off. (**BEEP WARN on off** under **DISPLAY**; Query)

BR

Calculates and displays the complex ratio of input B to input R. (**B/R** under **MENU**; Query)

C0 value

Enters the constant term of the open circuit capacitor model value, C_0 . (**C0** under **CAL**)
value 0 to 1000 ($\times 10^{-15}$ F).

C1 value

Enters the constant term of the open circuit capacitor model value, C_1 . (**C1** under **CAL**)
value 0 to 1000 ($\times 10^{-27}$ F/Hz).

C2 value

Enters the constant term of the open circuit capacitor model value, C_2 . (**C2** under **CAL**)
value 0 to 1000 ($\times 10^{-36}$ F/Hz²).

CALCASSI

Shows the tabular listing of the calibration kit class assignment. (**CLASS ASSIGNMENT** under **COPY**)

CALI parameter

Selects the measurement calibration type. (Query)

parameter NONE, RESP, RAI, S111, S221, FUL2, or ONE2

CALIFUL2

Selects the full 2-port measurement calibration. (**FULL 2-PORT** under **CAL**; Query)

CALIONE2

Selects the one-path 2-port measurement calibration. (**ONE-PATH 2-PORT** under **CAL**; Query)

CALIRAI

Selects the response and isolation measurement calibration. (**RESPONSE & ISOL'N** under **CAL**; Query)

CALIRESP

Selects the response measurement calibration. (**RESPONSE** under **CAL**); Query)

CALIS111

Selects the 1-port measurement calibration at port 1. (**S11 1-PORT** under **CAL**); Query)

CALIS221

Selects the 1-port measurement calibration at port 2. (**S22 1-PORT** under **CAL**); Query)

CALK *parameter*

Selects the calibration kit. (Query)

parameter APC7, N50, N75, or USED.

CALK7MM

Selects the 7 mm calibration kit. (**CAL KIT: 7mm** under **CAL**); Query)

CALKN50

Selects the 50 Ω type-N calibration kit. (**N 50 Ω** under **CAL**); Query)

CALKN75

Selects the 75 Ω type-N calibration kit. (**N 75 Ω** under **CAL**); Query)

CALKUSED

Selects a calibration kit model defined or modified by the user. (**USER KIT** under **CAL**); Query)

CALN

Selects using no calibration. (**CALIBRATE: NONE** under **CAL**); Query)

CALP

Calculates the parameters of the conjugate matching circuit. (**CALCULATE PARAMETERS** under **DISPLAY**)

CALS *value*

Provides the tabular listing of the standard setting. (**STD NO.1** to **STD NO.8** under **COPY**)
value 1 to 8.

CBRI *value*

Sets the color brightness in percent. (**BRIGHTNESS** under **DISPLAY**; Query)
value 0 to 100 (%).

CENT *value* [*suffix*]

Sets the center stimulus value. (**CENTER**), or **CENTER** under **MENU**; Query)
value 5 (Hz) to 500 (MHz), or
 -50 (dBm) to +15 (dBm) (Power sweep only).
suffix Refer to "Suffix".

CHAIRANG

Changes the IF range set channel (R to A to B). (Under **SERVICE MENU** under **SYSTEM**)

CHAN1

Selects channel 1 as the active measurement channel. (**CH 1**; Query)

CHAN2

Selects channel 2 as the active measurement channel. (**CH 2**; Query)

CLAD

Completes specifying the class. (**CLASS DONE (SPE'D)** under **CAL**)

CLASS11{A|B|C}

Selects port 1 (S11) one-port calibration standard class: S11A (open), S11B (short), or S11C (load). (**[S11] : OPEN**, **SHORT**, or **LOAD** under **CAL**)

CLASS22{A|B|C}

Selects port 2 (S22) one-port calibration standard class: S22A (open), S22B (short), or S22C (load). (**[S22] : OPEN**, **SHORT**, or **LOAD** under **CAL**)

CLEL

Clears the current frequency list. (CLEAR LIST YES under MENU)

CLEM{1-8}

Clears the marker. (MARKER 1 to MARKER 8 under MKR)

CLES

Clears the status byte, the event status register, the event status register B, and the operational status register.

CLEPTRIP

Clears the power trip. (CLEAR POWER TRIP under MENU)

COLO{CH1D|CH1M|CH2D|CH2M|GRAT|TEXT|WARN}

Specifies the display element to change color: channel 1 data, channel 1 memory and limit lines, channel 2 data, channel 2 memory and limit lines, a text, or a warning message. (CH1 DATA, CH1 MEM LIMIT LN, CH2 DATA, CH2 MEM LIMIT LN, GRATICULE, TEXT, WARNING under DISPLAY)

COLOIBT

Specifies the display element to change color: the HP Instrument BASIC text. (IBASIC under DISPLAY) (Option 002 only)

COLOR *value*

Specifies the saturation percent of the specified display element. (COLOR under DISPLAY; Query)

value 0 to 100 (%).

CONM{ON|OFF}

Sets conjugate matching on or off. (CONJ MATCH on off under DISPLAY; Query)

CONPCP *value* [F]

Displays or changes parameter value Cp for the selected conjugate matching circuit. (Cp under DISPLAY; Query)

value 1.0E-18 (F) to 1.0E+9 (F).

CONPCS *value* [F]

Displays or changes parameter value Cs for the selected conjugate matching circuit. (Cs under **DISPLAY**; Query)

value 1.0E-18 (F) to 1.0E+9 (F).

CONPLP *value* [H]

Displays or changes parameter value Lp for the selected conjugate matching circuit. (Lp under **DISPLAY**; Query)

value 1.0E-18 (H) to 1.0E+9 (H).

CONPLS *value* [H]

Displays or changes parameter value Ls for the selected conjugate matching circuit. (PARAMETER:Ls under **DISPLAY**; Query)

value 1.0E-18 (H) to 1.0E+9 (H).

CONPDISP {ON|OFF}

Displays or does not displays the conjugate matching parameters on the CRT. (CNJ.P DISP on off under **DISPLAY**)

CONT

Continuous trigger. (CONTINUOUS under **MENU**; Query)

CONV *parameter*

Selects the conversion setting of the measured data, impedance or admittance. (Query)

parameter OFF, ZREF, ZTRA, YREF, YTRA, or ONEDS

CONV1DS

Expresses the data in inverse S-parameter values. (1/S under **MEAS**; Query)

CONVOFF

Turns off all parameter conversion operations. (OFF under **MEAS**; Query)

CONVYREF

Converts reflection data to its equivalent admittance values. (**Y: Refl** under **MEAS**); Query)

CONVYTRA

Converts transmission data to its equivalent admittance values. (**Y: Trans** under **MEAS**); Query)

CONVZREF

Converts reflection data to its equivalent impedance values. (**Z: Refl** under **MEAS**); Query)

CONVZTRA

Converts transmission data to its equivalent impedance values. (**Z: Trans** under **MEAS**); Query)

COPA

Aborts printing or plotting in progress. (**COPY ABORT** under **COPY**)

COPT{ON|OFF}

Sets the time stamp function on or off. (**COPY TIME on off** under **COPY**); Query)

CORR{ON|OFF}

Sets the error correction function on or off. (**CORRECTION on off** under **CAL**); Query)

COUC{ON|OFF}

Sets the channel coupling of stimulus values on or off. (**COUPLED CH on off** under **MENU**); Query)

CWFREQ *value* [*suffix*]

Sets the frequency for power sweep. (**CWFREQ** under **MENU**); Query)

value 5 (Hz) to 500 (MHz).

suffix Hz or MHz.

DATI

Stores the active channel data to trace memory. (**DATA → MEM** under **DISPLAY**)

DAYMYEAR

Sets the displayed date mode to day/month/year order. (**DayMonYear** under **SYSTEM**; Query)

DCBUS *value*

Selects the DC bus. (Under **SERVICE MENU** under **SYSTEM**; Query)

value 0 to 20.

DCCOR{ON|OFF}

Sets the dc detector linearity correction on or off. (**DC CORR on off** under **CAL**; Query)

DEFC

Returns all traces, lines, and text to the default colors. (**DEFAULT COLORS** under **Display**)

DEFS *value*

Defines the number of the calibration standard to be modified. (**DEFINE STANDARD** under **CAL**)

value 1 to 8.

DELA

Selects the Delay format for the current measurement. (**DELAY** under **FORMAT**; Query)

DELO

Sets the delta marker mode off. (**Δ MODE OFF** under **MKR**; Query)

DEL R{1-8}

Selects the delta reference marker. (**Δ REF = 1** to **Δ REF = 8** under **MKR**; Query)

DELRFIXM

Sets the user-specified fixed reference marker. (**AREF=A FIXED MKR** under **MKR**; Query)

DESTOFF

Sets destructive testing off. (Under **SERVICE MENU** under **SYSTEM**; Query)

DESTON

Sets destructive testing on. (Under **SERVICE MENU** under **SYSTEM**; Query)

DFLT

Returns the plotting parameters to the default values. (**DEFAULT SETUP** under **COPY**)

DISA *parameter*

Selects the display allocation mode. (Query) (Option 002 only)

parameter ALLI, HIHB, or ALLB

DISAALLB

Displays only the HP Instrument BASIC display on the HP 8751A's CRT. (**ALL BASIC** under **DISPLAY**; Query) (Option 002 only)

DISAALLI

Displays only the measurement graticule on the HP 8751A's CRT. (**ALL INSTRUMENT** under **DISPLAY**; Query) (Option 002 only)

DISABASS

Displays only the HP Instrument BASIC status on the HP 8751A's CRT. (**BASIC STATUS** under **DISPLAY**; Query) (Option 002 only)

DISAHIHB

Displays the measurement graticule (top half) and the HP Instrument display (bottom half) on the HP 8751A's CRT. (**HALF INSTR HALF BASIC** under **DISPLAY**; Query) (Option 002 only)

DISL{1|2}

Selects the list sweep table 1 or 2 to be displayed and hard copied. (**DISL1** or **DISL2** under **COPY**)

DISLLIST

Displays the limit table on the display. (**DISPLAY LIST** under **COPY**)

DISMCTSP

Displays the list sweep stimulus range in the center and span format. (**CTR & SPAN** under **COPY**; Query)

DISMMD

Selects the middle and delta format for the limit testing table. (**MID & DLT** under **COPY**; Query)

DISMNUM

Displays the list sweep stimulus resolution in the number of points format. (**NUMBER of POINTS** under **COPY**; Query)

DISMSTEP

Displays the list sweep stimulus resolution in the step size format. (**STEP SIZE** under **COPY**; Query)

DISMSTSP

Displays the list sweep stimulus range in the start and stop format. (**DISP MODE: ST & SP** under **COPY**; Query)

DISMUL

Selects the upper and lower format for the limit testing table. (**DISP MODE: UPR & LWR** under **COPY**; Query)

DISP parameter

Selects the display trace type. (Query)

parameter DATA, MEMO, DATM, DDM, or DMM

DISPDATA

Displays a trace of the measured data. (`DISPLAY: DATA` under `DISPLAY`); Query)

DISPDATM

Displays traces of both the measured data and the memory data. (`DATA and MEMORY` under `DISPLAY`); Query)

DISPDDM

Displays the trace of the results of the measured data divided by the memory data. (`DATA/MEM` under `DISPLAY`); Query)

DISPDMM

Displays the trace of the results of the measured data subtracted by the memory data. (`DATA-MEM` under `DISPLAY`); Query)

DISPMEMO

Displays a trace of the memory data. (`MEMORY` under `DISPLAY`); Query)

DONE

Completes the measurement of the selected standard class calibration. (`DONE: OPENS`, `DONE: SHORTS`, or `DONE: LOADS` under `CAL`)

DUAC{ON|OFF}

Selects the dual (ON) or single (OFF) channels display. (`DUAL CHAN on off` under `DISPLAY`); Query)

EDITDONE

Completes editing the frequency list for the list sweep. (`LIST DONE` under `MENU`)

EDITLIML

Begins editing the limit line table. (`EDIT LIMIT LINE` under `SYSTEM`)

EDITLIS1

Selects list 1 for editing. (**EDIT: LIST 1** under **MENU**); Query)

EDITLIS2

Selects list 2 for editing. (**LIST 2** under **MENU**); Query)

EDITLIST

Begins editing the frequency list. (**EDIT LIST** under **MENU**)

ELED *value* [s]

Sets the electrical delay. (**ELECTRICAL DELAY** under **SCALE REF**); Query)

value -10 (s) to 10 (s).

ESB?

Outputs the event status register B value.

ESNB *value*

Specifies the bits of event status register B.

value 0 to 32767 ($=2^{15}-1$).

EXEDCALI

Executes the dc detector lineality calibration. (**EXECUTE DC CAL** under **CAL**)

EXET

Executes the service test. (Under **SERVICE MENU** under **SYSTEM**)

EXPP

Selects the expanded phase format for the current measurement. (**EXPANDED PHASE** under **FORMAT**); Query)

EXTRLOCK?

Outputs the state of the external reference (locked or unlocked). (Under **SERVICE MENU** under **SYSTEM**)

EXTT *parameter*

Selects the external trigger mode. (Query)

parameter OFF, ONSWEE, ONPOIN, or MAN.

EXTTOFF

Sets the internal measurement trigger mode (external trigger off). (**TRIGGER: TRIG OFF** under **MENU**); Query)

EXTTON

Sets the external measurement trigger mode on. When triggered, one measurement sweep is executed. (**EXT. TRIG ON SWEEP** under **MENU**); Query)

EXTTPOIN

Sets the external measurement trigger mode on. When triggered, one point is measured. (**EXT. TRIG ON POINT** under **MENU**); Query)

FBUS *value*

Selects the frequency bus. (Under **SERVICE MENU** under **SYSTEM**)

value 0 to 5.

FIRLANOR

Sets first local ALC to normal. (Under **SERVICE MENU** under **SYSTEM**); Query)

FIRLAOPE

Sets first local ALC to open. (Under **SERVICE MENU** under **SYSTEM**); Query)

FIRLPNOR

Sets first local PLL to normal. (Under **SERVICE MENU** under **SYSTEM**); Query)

FIRLPOPE

Sets first local PLL to open. (Under **SERVICE MENU** under **SYSTEM**; Query)

FIRR?

Outputs the firmware revision. (Under **SERVICE MENU** under **SYSTEM**)

FMT *parameter*

Selects the display format. (Query)

parameter LOGM, PHAS, DELA, SMIC, POLA, LINM, SWR, REAL, IMAG, EXPP, INVCHAR, LOGMP, or LOGMD

FNDAUTO

Sets FN DAC to auto. (Under **SERVICE MENU** under **SYSTEM**; Query)

FNDMANU

Sets FN DAC to manual. (Under **SERVICE MENU** under **SYSTEM**; Query)

FNDVALU *value*

Sets the FN DAC value. (Under **SERVICE MENU** under **SYSTEM**; Query)

value 0 to 255.

FNVNORM

Sets FN VCO to normal. (Under **SERVICE MENU** under **SYSTEM**; Query)

FNVOPEN

Sets FN VCO to open. (Under **SERVICE MENU** under **SYSTEM**; Query)

FREO

Erases the frequency annotation on the display. Preset to turn on. (**FREQUENCY BLANK** under **DISPLAY**; Query)

FORM2

Sets the IEEE 32-bit floating point format to transfer the trace data via HP-IB.

FORM3

Sets the IEEE 64-bit floating point format to transfer the trace data via HP-IB.

FORM4

Sets the ASCII transfer format to transfer the trace data via HP-IB.

FORM5

Sets the PC-DOS format to transfer the trace data via HP-IB.

FULP

Selects the full page plot. (**FULL PAGE** under **COPY**; Query)

FWDI

Selects forward isolation class for the calibration. (**FWD ISOL'N ISOL'N STD** under **CAL**)

FWDM

Selects forward match for the calibration. (**FWD MATCH THRU** under **CAL**)

FWDT

Selects forward transmission for the calibration. (**FWD TRANS THRU** under **CAL**)

GRODAPER *value* [pct]

Sets the group delay aperture. (**GROUP DELAY APERTURE** under **AVG**; Query)

value 1 to 200 (%).

HOLD

Holds the present measurement. (**HOLD** under **MENU**; Query)

IFBW *value* [*suffix*]

Sets the bandwidth value for IF bandwidth reduction. (**IF BW** under **AVG**); Query)

value 2 (Hz), 20 (Hz), 200 (Hz), 1000 (Hz), or 4000 (Hz).

suffix Hz or MHz.

IFBWAUTO

Automatically selects the proper IF bandwidth for each measurement point. (**IF BW AUTO** under **AVG**); Query)

IFRAUTO

Sets the auto range mode for the IF range of the selected channel. (Under **SERVICE MENU** under **SYSTEM**); Query)

IFRCH?

Outputs the IF range set channel. (Under **SERVICE MENU** under **SYSTEM**)

IFRX1

Sets the X1 range for the IF range. (Under **SERVICE MENU** under **SYSTEM**); Query)

IFRX1X8

Sets X1, X8 range for the IF range. (Under **SERVICE MENU** under **SYSTEM**); Query)

IFRX64

Sets X64 range for the IF range. (Under **SERVICE MENU** under **SYSTEM**); Query)

IFRX8X1

Sets X8, X1 range for the IF range. (Under **SERVICE MENU** under **SYSTEM**); Query)

IMAG

Displays only the imaginary (reactive) portion of the measured data in Cartesian format.

(**IMAGINARY** under **FORMAT**); Query)

INID

Initializes the disk in the built-in flexible disk drive. (**INITIALIZE DISK** under **SAVE**/**RECALL**)

INP8IO

Inputs data from the 4-bit parallel input port to the HP 8751A.

INPUCALC{01-12} *value*

Stores the measurement calibration error coefficient set real/imaginary pairs input via HP-IB into instrument memory. Refer to Appendix D for calibration array assignments.

value Complex number. (Data format: real, imaginary)

INPUCALK *value*

Retransmits the calibration kit data transmitted by the OUTPCALK? command.

value Block data. (Data format: HP 8751A internal format (714 bytes of binary data))

INPUDATA *value*

Inputs the error corrected data.

value Complex number. (Data format: real, imaginary)

INPUFORM *value*

Inputs formatted data.

value Complex number. (Data format: real, imaginary)

INPURAW{1-4} *value*

Inputs raw data.

value Complex number. (Data format: real, imaginary)

INPUUFORM *value*

Inputs unformatted data. This command is invalid, when **MEMORY** or **DATA and MEMORY** is selected as a trace.

value Complex number. (Data format: real, imaginary)

INTE value

Sets the display intensity as a percent of the brightest setting. (**INTENSITY** under **DISPLAY**; Query)

value 0 to 100 (%).

INVSCHAR

Displays an inverse Smith chart (admittance Smith chart) format. (**INV SMITH CHART** under **FORMAT**; Query)

ISOD

Completes the isolation part of the 2-port calibration. (**ISOLATION DONE** under **CAL**)

ISOL

Begins the isolation part of the 2-port calibration. (**ISOLATION** under **CAL**)

KEY value

Sends the key code for a hardkey or a softkey on the front panel. This is equivalent to actually pressing a key. Refer to Appendix C for key codes.

value 0 to 49.

KITD

Ends the calibration kit modification process. (**KIT DONE** under **CAL**)

LABEFWD{M|T} string

Defines the label for forward match or forward transmission class during modifying the calibration kit. (**FWD. MATCH** or **LABEL: FWD. TRANS.** under **CAL**)

string Up to ten characters long.

LABERES{!P} string

Defines the label for response and isolation, or response class when modifying the calibration kit. (**RESPONSE & ISOL'N** or **RESPONSE** under **CAL**)

string Up to ten characters long.

LABEREV{M|T} *string*

Defines the label for reverse match or reverse transmission class during modifying the calibration kit. (**REV.MATCH** or **REV.TRANS.** under **CAL**)

string Up to ten characters long.

LABES11{A|B|C} *string*

Defines the label for S11A (opens), S11B (shorts), or S11C (loads) class when modifying the calibration kit. (**LABEL: S11A**, **S11B**, or **S11C** under **CAL**)

string Up to ten characters long.

LABES22{A|B|C} *string*

Defines the label for S22A (opens), S22B (shorts), or S22C (loads) class when modifying the calibration kit. (**LABEL: S22A**, **S22B**, or **S22C** under **CAL**)

string Up to ten characters long.

LABK *string*

Defines the calibration kit label when modifying the calibration kit. (**LABEL KIT** under **CAL**)

string Up to ten characters long.

LABS *string*

Defines the calibration standard label when modifying the calibration kit. (**LABEL STD** under **CAL**)

string Up to ten characters long.

LEFL

Sets the plot quadrant to left lower. (**LEFT LOWER** under **COPY**; Query)

LEFU

Sets the plot quadrant to left upper. (**LEFT UPPER** under **COPY**; Query)

LIMCLEL

Clears all of segments in the limit test. (**CLEAR LIST YES** under **SYSTEM**)

LIMD *value* [*suffix*]

Sets the limits delta value from the specified middle value. (**DELTA LIMITS** under **SYSTEM**); Query)

value :0 to 5.0E+5 (dB) (Log mag format),
 0 to 5.0E+5 (deg) (Phase and Expanded phase formats),
 0 to 5.0E+5 (s) (Delay format),
 0 to 5.0E+5 (ohm) (Smith chart and Inv. Smith chart formats),
 0 to 5.0E+5 (Units) (Polar, Lin mag, Real, and Imaginary formats), or
 0 to 5.0E+5 (SWR format).

suffix Refer to "Suffix".

LIMEDONE

Completes editing the limit table. (**DONE** under **SYSTEM**)

LIMIAMPO *value* [*suffix*]

Sets an amplitude offset value for limit testing. (**AMPLITUDE OFFSET** under **SYSTEM**); Query)

value -5.0E+5 (dB) to 5.0E+5 (dB) (Log mag format),
 -5.0E+5 (deg) to 5.0E+5 (deg) (Phase and Expanded phase format),
 -5.0E+5 (s) to 5.0E+5 (s) (Delay format),
 -5.0E+5 (ohm) to 5.0E+5 (ohm) (Smith chart and Inv. Smith chart
 formats),
 -5.0E+5 (Units) to 5.0E+5 (Units) (Polar, Lin mag, Real, and Imaginary
 formats), or
 -5.0E+5 to 5.0E+5 (SWR format).

suffix Refer to "Suffix".

LIMILINE {**ON**|**OFF**}

Sets limit lines on or off. (**LIMIT LINE on off** under **SYSTEM**); Query)

LIMIMAOF

Sets the active marker value to the amplitude offset for limit testing. (**MARKER → AMP. OFS** under **SYSTEM**)

LIMISTIO *value* [*suffix*]

Sets a stimulus offset value for limit testing. (**STIMULUS OFFSET** under **SYSTEM**; Query)

value -500 (MHz) to 500 (MHz) (Frequency sweep), or
 -50 (dBm) to 50 (dBm) (Power sweep).

suffix Refer to "Suffix".

LIMITEST{ON|OFF}

Sets the limit testing on or off. (**LIMIT TEST on off** under **SYSTEM**; Query)

LIML *value* [*suffix*]

Sets the lower limit value for a limit testing segment. (**LOWER LIMIT** under **SYSTEM**; Query)

value -5.0E+5 (dB) to 5.0E+5 (dB) (Log mag format),
 -5.0E+5 (deg) to 5.0E+5 (deg) (Phase and Expanded phase formats),
 -5.0E+5 (s) to 5.0E+5 (s) (Delay format),
 -5.0E+5 (ohm) to 5.0E+5 (ohm) (Smith chart and Inv. Smith chart
 formats),
 -5.0E+5 (Units) to 5.0E+5 (Units) (Polar, Lin mag, Real, and Imaginary
 formats), or
 -5.0E+5 to 5.0E+5 (SWR format).

suffix Refer to "Suffix".

LIMM *value* [*suffix*]

Sets the middle value of delta limits. (**MIDDLE VALUE** under **SYSTEM**; Query)

value -5.0E+5 (dB) to 5.0E+5 (dB) (Log mag format),
 -5.0E+5 (deg) to 5.0E+5 (deg) (Phase and Expanded phase formats),
 -5.0E+5 (s) to 5.0E+5 (s) (Delay format),
 -5.0E+5 (ohm) to 5.0E+5 (ohm) (Smith Chart and Inv. Smith chart
 formats),
 -5.0E+5 (Units) to 5.0E+5 (Units) (Polar, Lin mag, Real, and Imaginary
 formats), or
 -5.0E+5 to 5.0E+5 (SWR format).

suffix Refer to "Suffix".

LIMS value [suffix]

Sets the starting stimulus value of a limit testing segment. (**STIMULUS VALUE** under **SYSTEM**; Query)

value 5 (Hz) to 500 (MHz) (Frequency sweep), or
 -50 (dBm) to 15 (dBm) (Power sweep).

suffix Refer to "Suffix".

LIMSADD

Adds a new segment to the end of the limit list. (**ADD** under **SYSTEM**)

LIMSDEL

Deletes a limit testing segment. (**DELETE** under **SYSTEM**)

LIMSDON

Completes editing the limit segments. (**DONE** under **SYSTEM**)

LIMSEDI value

Opens the segment to define or modify the stimulus and limit values. (**EDIT** under **SYSTEM**; Query)

value 1 to 18.

LIMU value [suffix]

Sets the upper limit value for a limit testing segment. (**UPPER LIMIT** under **SYSTEM**; Query)

value -5.0E+5 (dB) to 5.0E+5 (dB) (Log mag format),
 -5.0E+5 (deg) to 5.0E+5 (deg) (Phase and Expanded phase formats),
 -5.0E+5 (s) to 5.0E+5 (s) (Delay format),
 -5.0E+5 (ohm) to 5.0E+5 (ohm) (Smith chart and Inv. Smith chart
 formats),
 -5.0E+5 (Units) to 5.0E+5 (Units) (Polar, Lin mag, Real, and Imaginary
 formats), or
 -5.0E+5 to 5.0E+5 (SWR format).

suffix Refer to "Suffix".

LINFREQ

Activates a linear frequency sweep. (**LIN FREQ** under **MENU**); Query)

LINM

Displays the linear magnitude format. (**LIN MAG** under **FORMAT**); Query)

LINT{DATA|MEMO} *value*

Selects the line type of a trace for plotting. (**LINE TYPE DATA** or **LINE TYPE MEMORY** under **COPY**)

value 0 to 7.

LISDFBASE

Displays the measured data for the range between the minimum and maximum frequency set in the "Edit List Menu." (**LIST DISP: FREQ BASE** under **MENU**); Query)

LISDOBASE

Displays the measured data for only the frequency ranges set in the "Edit List Menu." (**ORDER BASE** under **MENU**); Query)

LISFREQ

Activates the frequency list sweep mode. (**LIST FREQ** under **MENU**); Query)

LISLIS1

Activates LIST 1 for the list sweep. (**SWEEP BY: LIST 1** under **MENU**); Query)

LISLIS2

Activates LIST 2 for the list sweep. (**LIST 2** under **MENU**); Query)

LISV

Displays a tabular listing of all the stimulus values and their current measured values. (**LIST VALUES** under **COPY**)

LOGFREQ

Activates log frequency sweep mode. (**LOG FREQ** under **MENU**); Query)

LOGM

Displays in log magnitude format. (**LOG MAG** under **FORMAT**); Query)

LOGMD

Displays the log magnitude trace and delay trace simultaneously. (**LOG MAG & DELAY** under **FORMAT**); Query)

LOGMP

Displays the log magnitude trace and phase trace simultaneously. (**LOG MAG & PHASE** under **FORMAT**); Query)

MANTRIG

Triggers measurement at one point. (**MANUAL TRG ON POINT** under **MENU**); Query)

MARK{1-8} value [suffix]

Selects the active marker, and moves it to the specified stimulus value. (**MARKER 1** to **MARKER 8** under **MKR**); Query)

value 5 (Hz) to 500 (MHz) (Frequency sweep), or
 -50 (dBm) to +15 (dBm) (Power sweep).

suffix Refer to "Suffix".

MARKBUCK value

Moves the active marker to specified data point number.

value 1 to "number of points".

MARKCENT

Changes the stimulus center value to the active marker value. (**MARKER — CENTER** under **MKR FCTN**)

MARKCONT

Interpolates between measured points to allow the markers to be placed at any point on the trace. (**CONTINUOUS** under **MKR**); Query)

MARKCOUP

Couples the marker stimulus values for the two display channels. (**MARKERS: COUPLED** under **MKR**); Query)

MARKDELA

Enters the group delay at the active marker point of a fixed frequency aperture to the electrical delay to balance the phase of the DUT. (**MARKER → DELAY** under **SCALE REF**)

MARKDISC

Places markers only on measured trace points determined by the stimulus settings. (**MARKERS: DISCRETE** under **MKR**); Query)

MARKFAUV *value* [*suffix*]

Sets the fixed marker auxiliary value offset. (**FIXED MKR AUX VALUE** under **MKR**); Query)

value -5.0E+6 (ohm) to 5.0E+6 (ohm) (Smith chart and Inv. Smith chart formats), or

 -5.0E+6 (deg) to 5.0E+6 (deg) (Polar format).

suffix Refer to "Suffix".

MARKFSTI *value* [*suffix*]

Sets the fixed marker stimulus value offset. (**FIXED MKR STIMULUS** under **MKR**); Query)

value -5000 (MHz) to 5000 (MHz) (Frequency sweep), or

 -99999 (dBm) to 99999 (dBm) (Power sweep).

suffix Refer to "Suffix".

MARKFVAL *value* [*suffix*]

Sets the fixed marker position value offset. (**FIXED MKR VALUE** under **MKR**); Query)

value -5.0E+5 (dB) to 5.0E+5 (dB) (Log mag format),

 -5.0E+5 (deg) to 5.0E+5 (deg) (Phase and Expanded phase formats),

 -5.0E+5 (s) to 5.0E+5 (s) (Delay format),

 -5.0E+5 (ohm) to 5.0E+5 (ohm) (Smith chart and Inv. Smith chart formats),

-5.0E+5 (Units) to 5.0E+5 (Units) (Polar, Lin mag, Real, and Imaginary formats), or

-5.0E+5 to 5.0E+5 (SWR format).

suffix Refer to "Suffix".

MARKL{ON|OFF}

Displays (ON) or does not display (OFF) the list of stimulus values and response values of all markers. (MKR LIST on off under MKR); Query)

MARKMIDD

Sets the middle value for the delta limit using to the active marker value. (MIDDLE VALUE under SYSTEM)

MARKODATA

Enables the marker to move on the measurement data trace. (MARKERS ON [DATA] under MKR); Query)

MARKOFF

Turns off all the markers and the delta reference marker. (ALL MKR OFF under MKR); Query)

MARKOMEMO

Enables the marker to move on the memory data trace. (MARKERS ON [MEMO] under MKR); Query)

MARKPEAD

Changes the differential stimulus value and the response value of the peak for searching the local max, min, and peak-to-peak. (MARKER — PEAK DEF under MKR FCTN)

MARKREF

Changes the reference value to the active marker's response value, without changing the reference position. (MARKER — REFERENCE under SCALE REF or MKR FCTN)

MARKSPAN

Changes the start and stop values of the stimulus span to the active marker and the delta reference marker. (MARKER — SPAN under MKR FCTN)

MARK{STAR|STOP}

Changes the stimulus start or stop value to the active marker value. (MARKER → START, MARKER → STOP under MKR FCTN)

MARKSTIM

Sets the stimulus value of a segment to the active marker value. (MARKER → STIMULUS under SYSTEM)

MARKTIME{ON|OFF}

Sets the x-axis marker readout to the sweep time (ON), or cancels the setting (OFF). (MKR TIME on off under MKR; Query)

MARKUNCO

Allows the marker stimulus values to be controlled independently on each channel. (UNCOUPLED under MKR; Query)

MARKZERO

Puts a fixed reference marker at the present active marker position, and makes the fixed marker stimulus and response values at that position equal to zero. (MKR ZERO under MKR)

MEAS *parameter*

Selects the parameters or inputs to be measured. (Query)

parameter AR, BR, AB, A, B, R, S11, S12, S21, S22, BDC, or BDCR.

MEASA

Measures the absolute power amplitude at input A. (A under MEAS; Query)

MEASB

Measures the absolute power amplitude at input B. (B under MEAS; Query)

MEASR

Measures the absolute power amplitude at input R. (R under MEAS; Query)

MEASTAT{ON|OFF}

Calculates and displays the mean, standard deviation, and peak-to-peak values among the search range (ON), or does not display them (OFF). (**STATISTICS** under **MKR FCTN**); Query)

MIXLPNOR

Sets the mixer local port to normal. (Under **SERVICE MENU** under **SYSTEM**); Query)

MIXLPTES

Sets the mixer local port to test. (Under **SERVICE MENU** under **SYSTEM**); Query)

MOD11

Leads to the modify calibration kit menu, where a calibration kit can be user-modified. (**MODIFY** under **CAL**)

MONDYEAR

Changes the displayed date to the "month:day:year" format. (**DATE MODE: MonDayYear** under **SYSTEM**); Query)

NEXP

Displays the next page of information in a tabular listing onto the display. (**NEXT PAGE** under **COPY**)

NUMG *value*

Triggers a user-specified number of sweeps, and returns to the hold mode.

(**NUMBER OF GROUPS** under **MENU**)

value Greater than 0.

OFSD *value* [s]

Specifies the one-way electrical delay from the measurement (reference) plane to the standard.

(**OFFSET DELAY** under **CAL**)

value -10 (s) to 10 (s).

OFSL *value*

Specifies energy loss, due to skin effect, along a one-way length of coaxial cable offset.

(**OFFSET LOSS** under **CAL**)

value 0 to 1.0E+19 (Ω/s).

OFSZ *value* [**ohm**]

Specifies the characteristic impedance of the coaxial cable offset. (**OFFSET ZO** under **CAL**)

value 0.1 (ohm) to 5.0E+6 (ohm).

OMII

Omits the correction for isolation of a 2-port calibration. (**OMIT ISOLATION** under **CAL**)

OPEP

Lists the key parameters for both channel 1 and 2 on the display. (**OPERATING PARAMETERS** under **COPY**)

OSE *value*

Enables the operational status register.

value 0 to 32767.

OSR?

Outputs the operational status register value.

OUT8IO *value*

Outputs the data to the 8-bit parallel output port.

value 0 to 32767.

OUTPCALC{01-12}?

Outputs the active calibration set array of the active channel (Data format: real, imaginary). Refer to Appendix D for the calibration set array.

OUTPCALK?

Outputs the active calibration kit. (Data format: block data (714 bytes of binary data))

OUTPDATA?

Outputs the error corrected data (Data format: real, imaginary).

OUTPDATAP? *value*

Outputs the error corrected data at the specified point (Data format: real, imaginary).

value 1 to "number of points."

OUTPERRO?

Outputs the error message in the error queue (Data format: ASCII No., "string").

OUTPFAIP?

Outputs the detailed information of the limit test at the failed point (Data format: stimulus, result, upper limit, lower limit).

OUTPFBUS?

Outputs the FBUS data. (Under SERVICE MENU under SYSTEM)

OUTPFORM?

Outputs the formatted trace data (Data format: real, imaginary)

OUTPFORMP? *value*

Outputs the formatted trace data at the specified point (Data format: real, imaginary)

value 1 to "number of points."

OUTPIFORM?

Outputs the formatted data from the inactive channel (Data format: real, imaginary)

OUTPINP8IO?

Outputs the data entered from the 4-bit parallel input port.

OUTPIRFORM?

Outputs the real part of the formatted data from the inactive channel.

OUTPIRTMEM?

Outputs the real part of the trace memory data from the inactive channel.

OUTPITMEM?

Outputs the trace memory data from the inactive channel. (Data format: real, imaginary)

OUTPLIMF?

Outputs the limit test results only for the failed points. (Data format: stimulus, result (0 for fail, -1 for no test), upper limit, lower limit; Form 4)

OUTPLIML?

Outputs the limit test results for each point. (Data format: stimulus, result (1 for pass, 0 for fail, -1 for no test), upper limit, lower limit; Form 4)

OUTPLIMM?

Outputs the limit test result for the maker position. (Data format: stimulus, result (1 for pass, 0 for fail, -1 for no test), upper limit, lower limit)

OUTPMARK?

Outputs the active marker values. (Data format: marker value, marker aux. value, stimulus)

OUTPMEMO?

Outputs the memory data from the active channel. (Data format: real, imaginary)

OUTPMEMOP? *value*

Outputs the memory data from the active channel at a specified point. (Data format: real, imaginary)

value 1 to "number of points."

OUTPMSTA?

Outputs the marker statistics. (Data format: mean, standard deviation, peak to peak)

OUTPMWID?

Outputs the results of the bandwidth search. (Data format: bandwidth, center, Q)

OUTPRAW{1-4}?

Output the uncorrected data arrays for the active channel. (Data format: real, imaginary)

OUTPRFORM?

Outputs the real part of the formatted data from the active channel.

OUTPRTMEM?

Outputs the real part of the trace memory data from the active channel.

OUTPSTIM?

Outputs the stimulus array data from the active channel.

OUTPTESS? *value*

Outputs the specified test number's result. (Under **SERVICE MENU** under **SYSTEM**)

value 0 to 85.

OUTPTITL?

Outputs the display title for the active channel (less than 54 characters).

OUTPTMEM?

Outputs the memory data from the active channel. (Data format: real, imaginary)

OUTPTMEMP? *value*

Outputs the memory data from the active channel at a specified point. (Data format: real, imaginary)

value 1 to "number of points."

OUTPUFORM?

Outputs the unformatted data from the active channel. (Data format: real, imaginary)

PARS{ON|OFF}

Sets the partial search of the marker search function on or off. (**PART SRCH on off** under **MKR FCTN**); Query)

PEADX *value* [*suffix*]

Defines the differential stimulus value of the peak for searching for the local max, min, and peak-to-peak. (**PEAK DEF: ΔX** under **MKR FCTN**; Query)

value -5000 (MHz) to 5000 (MHz) (Frequency sweep), or
 -500 (dBm) to 500 (dBm) (Power sweep).

suffix Refer to "Suffix".

PEADY *value* [*suffix*]

Defines the differential response value of the peak for searching for the local max, min, and peak-to-peak. (**ΔY** under **MKR FCTN**; Query)

value -5.0E+5 (dB) to 5.0E+5 (dB) (Log mag format),
 -5.0E+5 (deg) to 5.0E+5 (deg) (Phase and Expanded phase formats),
 -5.0E+5 (s) to 5.0E+5 (s) (Delay format),
 -5.0E+5 (ohm) to 5.0E+5 (ohm) (Smith chart and Inv. Smith chart
 formats),
 -5.0E+5 (Units) to 5.0E+5 (Units) (Polar, Lin mag, Real, and Imaginary
 formats), or
 -5.0E+5 to 5.0E+5 (SWR format).

suffix Refer to "Suffix".

PHAO *value* [deg]

Adds or subtracts a phase offset. (**PHASE OFFSET** under **SCALE REF**; Query)

value -360 (deg) to +360 (deg).

PHAS

Displays a Cartesian format of the phase portion of the data, measured in degrees. (**PHASE** under **FORMAT**; Query)

PLOALL

Selects plotting all the information displayed on the display except for the softkey.
(**PLOT: ALL** under **COPY**; Query)

PLOC *parameter*

Selects the plot elements. (Query)

parameter DONLY, DGRAT, or ALL.

PLODGRAT

Selects the measured data and memory data with the graticules for plotting.

(DATA & GRATCL under COPY; Query)

PLODONLY

Selects the measured data and the memory data without the graticules for plotting.

(DATA ONLY under COPY; Query)

PLOS{FAST|SLOW}

Sets the plotting speed to fast or slow. (PLOT SPEED under COPY)

PLOT

Plots the display to a graphics plotter. (PLOT under COPY)

POIN *value*

Sets the number of the data points per sweep. (NUMBER of POINTS under MENU; Query)

value 2 to 801.

POLA

Displays in polar format. (POLAR under FORMAT; Query)

POLM *parameter*

Selects the polar marker. (Query)

parameter LOG, LIN, or RI.

POLMLIN

Displays the linear magnitude and the phase of the active polar marker. (LIN MKR under

MKR; Query)

POLMLOG

Displays the logarithmic magnitude and the phase of the active polar marker. (**LOG MKR** under **MKR**); Query)

POLMRI

Displays a real and imaginary pair of the active polar marker. (**Re/Im MKR** under **MKR**); Query)

PORE {ON|OFF}

Sets the reference plane extension mode on or off. (**EXTENSIONS on off** under **CAL**); Query)

PORT1 *value* [s]

Extends the reference plane for measurement of S_{11} , S_{21} , and S_{12} . (**EXTENSION PORT 1** under **CAL**); Query)

value -10 (s) to 10 (s).

PORT2 *value* [s]

Extends the reference plane for measurement of S_{22} , S_{12} , and S_{21} . (**EXTENSION PORT 1** under **CAL**); Query)

value -10 (s) to 10 (s).

PORTA *value* [s]

Adds electrical delay to the input A reference plan for any A input measurements including S-parameters. (**EXTENSION INPUT A** under **CAL**); Query)

value -10 (s) to 10 (s).

PORTB *value* [s]

Adds electrical delay to the input B reference plane for any B input measurements including S-parameters. (**EXTENSION INPUT B** under **CAL**); Query)

value -10 (s) to 10 (s).

PORTR *value* [s]

Adds electrical delay to extend the reference plane at input R to the end of cable. (**EXTENSION INPUT R** under **CAL**); Query)

value -10 (s) to 10 (s).

POWDAUTO

Sets the power DAC to auto. (Under **SERVICE MENU** under **SYSTEM**)

POWDMAN

Sets the power DAC to manual. (Under **SERVICE MENU** under **SYSTEM**)

POWDVALU *value*

Sets the power DAC value. (Under **SERVICE MENU** under **SYSTEM**)

value 0 to 4095.

POWE *value* [dBm]

Sets the source output level. (**POWER** under **MENU**; Query)

value -50 (dBm) to +15 (dBm).

POWLANOR

Sets the power level ALC to normal. (Under **SERVICE MENU** under **SYSTEM**)

POWLAOPE

Sets the power level ALC to open. (Under **SERVICE MENU** under **SYSTEM**)

POWS

Activates a power sweep mode. (**POWER SWEEP** under **MENU**; Query)

PREP

Displays the previous page of information in a tabular listing. (**PREV PAGE** under **COPY**)

PRES

Presets the state. (**PRESET**)

PRINALL

Copies the measurement display to the printer according to plotting options. (**PRINT** under **COPY**)

PRIC

Selects color printing. (**COLOR** under **COPY**); Query)

PRICFIXE

Selects the default colors for printing a hard copy. (**PRINT COLOR [FIXED]** under **COPY**); Query)

PRICVARI

Selects the colors as similar as possible to the display for printing a hard copy. (**PRINT COLOR [VARIABLE]** under **COPY**); Query)

PRIS

Sets the print command to the default selection. (**PRINT: STANDARD** under **COPY**); Query)

PSOFT{ON|OFF}

Selects the plot softkey label option on or off.

PURG *string*

Removes a file saved on the disk in the built-in flexible disk drive. (**PURGE FILE** under **SAVE/RECALL**)

string File name. Up to 10 characters including the extension.

QUAD *parameter*

Selects the quadrant plot setting.

parameter LEFU, LEFL, RIGU, RIGL, or FULP.

RAID

Completes the response and isolation calibration. (**DONE RESP ISOL'N CAL** under **CAL**)

RAISOL

Selects the isolation class for the response and isolation calibration. (**ISOL'N STD** under **CAL**)

RAIRESP

Selects the response class for the response and isolation calibration. (**RESPONSE** under **CAL**)

REAL

Displays only the real (resistive) portion of the measured data in Cartesian format. (**REAL** under **FORMAT**; Query)

RECC

Recalls the previously saved color set. (**RECALL COLORS** under **DISPLAY**)

RECCOFF

Sets the receiver correction off. (Under **SERVICE MENU** under **SYSTEM**; Query)

RECCON

Sets the receiver correction on. (Under **SERVICE MENU** under **SYSTEM**; Query)

RECD *string*

Loads the instrument states or data from the disk in the built-in flexible disk drive. (**RECALL FILE** under **SAVE/RECALL**)

string File name. Up to 10 characters including the extension.

REFD

Completes with the reflection part of the full 2-port calibration. (**REFLECT'N DONE** under **CAL**)

REFL

Begins the reflection part of the full 2-port calibration. (**REFLECT'N** under **CAL**)

REFP *value*

Sets the position of the reference line on the graticule of a Cartesian format. (**REFERENCE POSITION** under **SCALE REF**; Query)

value 0 to 10 (Div).

REFV *value* [*suffix*]

Changes the value of the reference line, moving the measurement trace correspondingly.

(REFERENCE VALUE under SCALE REF); Query

value

- 500 (dB) to 500 (dB) (Log mag format),
- 5.0E+6 (deg) to 5.0E+6 (deg) (Phase or Expanded phase formats),
- 0.5 (s) to 0.5 (s) (Delay format),
- 1.0E-11 (Units) to 500 (Units) (Smith chart, Inv. Smith chart, or Polar formats),
- 5.0E+6 (Units) to 5.0E+6 (Units) (Lin man, Real, or Imaginary formats),
- or
- 5.0E+6 to 5.0E+6 (SWR format).

suffix Refer to "Suffix".

RESAVD *string*

Updates an already saved file on the disk in the built-in flexible disk drive. (RE-SAVE FILE under SAVE)

string File name. Up to 10 characters including the extension.

RESC

Resumes the last measurement calibration sequence. (RESUME CAL SEQUENCE under CAL)

RESD

Turns off the tabular listing and returns the measurement display to the screen.

(RESTORE DISPLAY under COPY)

RESPDONE

Completes the response calibration. (DONE: RESPONSE under CAL)

REST

Aborts the sweep in progress, then restarts the measurement. (MEASURE RESTART under

MENU)

REVI

Selects the reverse isolation class for the calibration. (**REV ISOL'N ISOL'N STD** under **CAL**)

REVM

Selects the reverse match class for the calibration. (**REV. MATCH THRU** under **CAL**)

REVT

Selects the reverse transmission class for the calibration. (**REV. TRANS. THRU** under **CAL**)

RFOPNORM

Sets the RF OSC PLL to normal. (Under **SERVICE MENU** under **SYSTEM**; Query)

RFOPEN

Sets the RF OSC PLL to open. (Under **SERVICE MENU** under **SYSTEM**; Query)

RIGL

Draws a quarter-page plot in the lower right quadrant of the page. (**RIGHT LOWER** under **COPY**; Query)

RIGU

Draws a quarter-page plot in the upper right quadrant of the page. (**RIGHT UPPER** under **COPY**; Query)

RSCO

Resets the modified colors to the default colors. (**RESET COLOR** under **DISPLAY**)

S11

Selects the S-parameter test set for measurement of S_{11} . (**Refl: FWD S11 (A/R)** under **MEAS**; Query)

S12

Selects the S-parameter test set for measurement of S_{12} . (**Trans: REV S12 (A/R)** under **MEAS**; Query)

S21

Selects the S-parameter test set for measurement of S_{21} . (**Trans: FWD S21 (B/R)** under **MEAS**; Query)

S22

Selects the S-parameter test set for measurement of S_{22} . (**Ref1: REV S22 (B/R)** under **MEAS**; Query)

SADD

Adds a new segment to a list sweep. (**ADD** under **MENU**)

SAV1

Saves the 1-port calibration results. (**DONE: 1-PORT CAL** under **CAL**)

SAV2

Saves the 2-port calibration results. (**DONE: 2-PORT CAL** under **CAL**)

SAVC

Re-draws a trace using current error coefficient arrays.

SAVCA{ON|OFF}

Sets the calibration coefficients arrays to be saved or not. (**CAL ARY on off** under **SAVE**; Query)

SAVDALL *string*

Saves the instrument states, the data array, and the memory array to the disk in the built-in flexible disk drive. (**SAVE ALL** under **SAVE**)

string File name. Up to 8 characters.

SAVDA{ON|OFF}

Sets the data arrays to be saved (ON) or not (OFF). (**DATA ARY on off** under **SAVE**; Query)

SAVDDAT *string*

Saves the internal data arrays which is defined by the SAVRA{ON|OFF}, SAVCA{ON|OFF}, SAVDA{ON|OFF}, SAVMA{ON|OFF}, SAVUA{ON|OFF}, SAVTA{ON|OFF}, and SAVTMA{ON|OFF}.
 (SAVE DATA ONLY under SAVE)

string File name. Up to 8 characters.

SAVDSTA *string*

Saves only the instrument states and the calibration coefficients to the disk in the built-in flexible disk drive. (SAVE STATE ONLY under SAVE)

string File name. Up to 8 characters.

SAVEUSEK

Stores the user-modified or user-defined calibration kit into memory. (SAVE USER KIT under CAL)

SAVMA{ON|OFF}

Sets the memory arrays to be saved (ON) or not (OFF). (MEMORY ARY on off under SAVE; Query)

SAVRA{ON|OFF}

Sets the raw data arrays to be saved (ON) or not (OFF). (RAW ARY on off under SAVE; Query)

SAVTA{ON|OFF}

Sets the trace arrays to be saved (ON) or not (OFF). (TRACE ARY on off under SAVE; Query)

SAVTMA{ON|OFF}

Sets the memory trace arrays to be saved (ON) or not (OFF). (T.MEM ARY on off under SAVE; Query)

SAVUA{ON|OFF}

Sets the unformatted data arrays to be saved (ON) or not (OFF). (UNFORM ARY on off under SAVE; Query)

SCAC

Couples the data and memory trace to be scaled. (**D&M SCALE [COUPLE]** under **SCALE REF**;
Query)

SCAFDATA

Selects the data trace to be scaled. (**SCALE FOR [DATA]** under **SCALE REF**; Query)

SCAFMEMO

Selects the memory trace to be scaled. (**SCALE FOR [MEMORY]** under **SCALE REF**; Query)

SCAL *value* [*suffix*]

Changes the response value scale per division of the graticule. (**SCALE/DIV** under **SCALE REF**;
Query)

value 0.001 (dB/div) to 500 (dB/div) (Log mag format),
 0.01 (deg/div) to 500 (deg/div) (Phase format),
 1.0E-11 (deg) to 10000 (deg) (Expanded phase format),
 1.0E-14 (s/div) to 10 (s/div) (Delay format),
 1.0E-11 (Units FS) to 10000 (Units FS) (Smith chart, Inv. Smith chart, and
 Polar format),
 1.0E-11 (Units/div) to 10000 (Units/div) (Lin mag, Real, and Imaginary
 formats), or
 1.0E-11 to 10000 (/div) (SWR format).

suffix Refer to "Suffix".

SCAPFULL

Selects the normal full size scale for plotting. (**SCALE: FULL** under **COPY**)

SCAPGL

Fits the lower graticule to the user-defined P1 and P2. (**LOWER GRATICULE** under **COPY**)

SCAPGU

Fits the upper graticule to the user-defined P1 and P2. (**UPPER GRATICULE** under **COPY**)

SCAU

Uncouples the data and memory trace to be scaled. (**D&M SCALE [UNCOUPLE]** under **SCALE REF**; Query)

SDEL

Deletes a segment from the list sweep. (**DELETE** under **MENU**)

SDON

Completes editing a segment of the list sweep. (**SEGMENT DONE** under **MENU**)

SEAL

Searches the trace for the next occurrence of the target value to the left of the marker. (**SEARCH LEFT** under **MKR FCTN**)

SEALMAX

Moves the active marker to the maximum peak point on the trace in the search range. (**LOCAL MAX** under **MKR FCTN**; Query)

SEALMIN

Moves the active marker to the minimum peak point on the trace in the search range. (**LOCAL MIN** under **MKR FCTN**; Query)

SEAM *parameter*

Selects the marker search function. (Query)

parameter OFF, MAX, MIN, TARG, MEAN, LMAX, LMIN, or PPEAK.

SEAMEAN

Moves the active marker to the mean point on the trace. (**SEARCH MEAN** under **MKR FCTN**; Query)

SEAMAX

Moves the active marker to the maximum point on the trace. (**MAX** under **MKR FCTN**; Query)

SEAMIN

Moves the active marker to the minimum point on the trace. (**MIN** under **MKR FCTN**); Query)

SEAOFF

Turns off the marker search function. (**SEARCH OFF** under **MKR FCTN**); Query)

SEAPPEAK

Moves the active marker and the delta reference marker to the maximum peak point and the minimum peak point on the trace in the search range. (**PEAK-PEAK** under **MKR FCTN**); Query)

SEAR

Searches the trace for the next occurrence of the target value to the right of the marker. (**SEARCH RIGHT** under **MKR FCTN**)

SEARSTOR

Stores the search range, which is defined between the active marker and the delta reference marker. (**SEARCH RNG STORE** under **MKR FCTN**)

SEATARG *value* [*suffix*]

Places the active marker at a specified target point on a trace. (**TARGET** under **MKR FCTN**); Query)

value -5.0E+5 (dB) to 5.0E+5 (dB) (Log mag format),
 -5.0E+5 (deg) to 5.0E+5 (deg) (Phase and Expanded phase formats),
 -5.0E+5 (s) to 5.0E+5 (s) (Delay format),
 -5.0E+5 (ohm) to 5.0E+5 (ohm) (Smith chart and Inv. Smith chart
 formats),
 -5.0E+5 (Units) to 5.0E+5 (Units) (Polar, Lin mag, Real, and Imaginary
 format), or
 -5.0E+5 to 5.0E+5 (SWR format).

suffix Refer to "Suffix".

SEDI *value*

Determines a segment of the list sweep to be modified. (**SEGMENT** under **MENU**); Query)

value 1 to 31...

SELC *parameter*

Selects the conjugate matching circuit type. (Query)

parameter LSLP, LSCP, CSLP, CSCP, LPLS, LPCS, CPLS, or CPCS

SELCCPCS

Selects the "Cp-Cs" circuit for conjugate matching. (**Cp-Cs** under **DISPLAY**); Query)

SELCCPLS

Selects the "Cp-Ls" circuit for conjugate matching. (**Cp-Ls** under **DISPLAY**); Query)

SELCCSCP

Selects the "Cs-Cp" circuit for conjugate matching. (**Cs-Cp** under **DISPLAY**); Query)

SELCCSLP

Selects the "Cs-Lp" circuit for conjugate matching. (**Cs-Lp** under **DISPLAY**); Query)

SELCLPCS

Selects the "Lp-Cs" circuit for conjugate matching. (**Lp-Cs** under **DISPLAY**); Query)

SELCLPLS

Selects the "Lp-Ls" circuit for conjugate matching. (**Lp-Ls** under **DISPLAY**); Query)

SELCLSCP

Selects the "Ls-Cp" circuit for conjugate matching. (**Ls-Cp** under **DISPLAY**); Query)

SELCLSLP

Selects the "Ls-Lp" circuit for conjugate matching. (**Ls-Lp** under **DISPLAY**); Query)

SELD

Execute the self diagnostics. (Under **SERVICE MENU** under **SYSTEM**)

SETCDATE *year,month,day*

Changes date of the internal clock. (**MONTH**, **DAY**, and **YEAR** under **SYSTEM**); Query)

year 1901 to 2059.
month 1 to 12.
day 1 to 31.

SETCTIME *hour,min,sec*

Changes time of the internal clock. (**HOUR**, **MIN**, and **SEC** under **SYSTEM**); Query)

hour 0 to 23.
min 0 to 59.
sec 0 to 59.

SETZ *value* [ohm]

Sets the characteristic impedance used by the HP 8751A in calculating measured impedance with the Smith chart markers and conversion parameters. (**SET Z0** under **CAL**); Query)

value 0.1 (ohm) to 5.0E+6 (ohm).

SING

Makes a single measurement sweep, then sets the hold mode. (**SINGLE** under **MENU**)

SMIC

Displays a Smith chart format. (**SMITH CHART** under **FORMAT**); Query)

SMIM *parameter*

Selects the form for the Smith marker. (Query)

parameter LIN, LOG, RI, RX, or GB.

SMIMGB

Displays the complex admittance values of the active marker position on a Smith chart in rectangular form. (**G+jB MKR** under **MKR**); Query)

SMIMLIN

Displays the linear magnitude value and the phase of the active marker position on a Smith chart. (**LIN MKR** under **MKR**; Query)

SMIMLOG

Displays the logarithmic magnitude value and the phase of the active marker on a Smith chart. (**LOG MKR** under **MKR**; Query)

SMIMRI

Displays the values of the active marker on a Smith chart as a real and imaginary pair. (**Re/Im MKR** under **MKR**; Query)

SMIMRX

Displays the complex impedance values of the active marker on a Smith chart in rectangular form. (**R+jX MKR** under **MKR**; Query)

SMOOAPER *value* [*pct*]

Changes the value of the smoothing aperture as a percent of the span. (**SMOOTHING APERTURE** under **AVG**; Query)

value 0.05 (%) to 100 (%)

SMOO{ON|OFF}

Sets the smoothing function to on or off. (**SMOOTHING on off** under **AVG**; Query)

SOUCOFF

Sets the source correction to off. (Under **SERVICE MENU** under **SYSTEM**; Query)

SOUCON

Sets the source correction to on. (Under **SERVICE MENU** under **SYSTEM**; Query)

SPAN *value* [*suffix*]

Sets the frequency span of a segment about a specified center frequency. (**SPAN** or **SPAN** under **MENU**; Query)

value 0 to 499.999995 MHz.

suffix Hz or MHz.

SPECFWDM A[,B[,C[,D[,E[,F[,G]]]]]]]

Enters the standard numbers for the forward match (THRU) calibration. (**FWD.MATCH** under **CAL**)

A, B, C, D, 1 to 8.
E, F, G

SPECFWDT A[,B[,C[,D[,E[,F[,G]]]]]]]

Enters the standard numbers for the forward transmission (THRU) calibration. (**FWD.TRANS** under **CAL**)

A, B, C, D, 1 to 8.
E, F, G

SPECRESI A[,B[,C[,D[,E[,F[,G]]]]]]]

Enters the standard numbers for the response and isolation calibration. (**RESPONSE & ISOL'N** under **CAL**)

A, B, C, D, 1 to 8.
E, F, G

SPECRESP A[,B[,C[,D[,E[,F[,G]]]]]]]

Enters the standard numbers for the response calibration. (**RESPONSE** under **CAL**)

A, B, C, D, 1 to 8.
E, F, G

SPECREVM A[,B[,C[,D[,E[,F[,G]]]]]]]

Enters the standard numbers for the reverse match (THRU) calibration. (**REV.MATCH** under **CAL**)

A, B, C, D, 1 to 8.
E, F, G

SPECREVT A[,B[,C[,D[,E[,F[,G]]]]]]]

Enters the standard numbers for the reverse transmission (THRU) calibration. (**REV.TRANS** under **CAL**)

A, B, C, D, 1 to 8.
E, F, G

SPECS11A A[,B[,C[,D[,E[,F[,G]]]]]]

Enters the standard numbers for the first class required for an S₁₁ 1-port calibration.

(SPECIFY: S11A under CAL)

A, B, C, D, 1 to 8.
E, F, G

SPECS11B A[,B[,C[,D[,E[,F[,G]]]]]]

Enters the standard numbers for the second class required for an S₁₁ 1-port calibration.

(S11B under CAL)

A, B, C, D, 1 to 8.
E, F, G

SPECS11C A[,B[,C[,D[,E[,F[,G]]]]]]

Enters the standard numbers for the third class required for an S₁₁ 1-port calibration. (S11C under CAL)

A, B, C, D, 1 to 8.
E, F, G

SPECS22A A[,B[,C[,D[,E[,F[,G]]]]]]

Enters the standard numbers for the first class required for an S₂₂ 1-port calibration.

(SPECIFY: S22A under CAL)

A, B, C, D, 1 to 8.
E, F, G

SPECS22B A[,B[,C[,D[,E[,F[,G]]]]]]

Enters the standard numbers for the second class required for an S₂₂ 1-port calibration.

(S22B under CAL)

A, B, C, D, 1 to 8.
E, F, G

SPECS22C A[,B[,C[,D[,E[,F[,G]]]]]]

Enters the standard numbers for the third class required for an S₂₂ 1-port calibration. (S22C under CAL)

A, B, C, D, 1 to 8.
E, F, G

SPLD{ON|OFF}

Sets the dual channel display mode: a full-screen single graticule display (OFF), or a split display with two half-screen graticules (ON). (**SPLIT DISP on off** under **DISPLAY**); Query)

STAN{A-G}

Measures the calibration standard in the current standard class. (**OPEN**, **SHORT**, **THRU**, **LOAD**, etc. under **CAL**)

STAR value [suffix]

Defines the start frequency of the stimulus. (**START**); Query)

Sets the start frequency of a segment. (**SEGMENT START** under **MENU**); Query)

value 5 (Hz) to 500 (MHz) (Frequency sweep), or
 -50 (dBm) to 15 (dBm) (Power sweep).

suffix Refer to "Suffix".

STDD

Completes the current standard definition. (**STD DONE (DEFINED)** under **CAL**)

STDT parameter

Selects the standard type. (Query)

parameter OPEN, SHOR, LOAD, DELA, or ARBI.

STDTARBI

Defines the standard type to LOAD with an arbitrary impedance. (**ARBITRARY IMPEDANCE** under **CAL**); Query)

STDTDELA

Defines the standard type as transmission line of specified length. (**DELAY/THRU** under **CAL**); Query)

STDTLOAD

Defines the standard type as LOAD (termination). (**LOAD** under **CAL**); Query)

STDTOPEN

Defines the standard type as an OPEN. (**OPEN** under **CAL**; Query)

STDTSHOR

Defines the standard type as a SHORT. (**SHORT** under **CAL**; Query)

STEODAUT

Sets the step OSC DAC to auto. (Under **SERVICE MENU** under **SYSTEM**; Query)

STEODMAN

Sets the step OSC DAC to manual. (Under **SERVICE MENU** under **SYSTEM**; Query)

STEODVAL *value*

Sets the step OSC DAC value. (Under **SERVICE MENU** under **SYSTEM**; Query)

value 0 to 255.

STEONORM

Sets the step OSC DAC to normal. (Under **SERVICE MENU** under **SYSTEM**; Query)

STEOOPEN

Sets the step OSC DAC to open. (Under **SERVICE MENU** under **SYSTEM**; Query)

STOP *value [suffix]*

Defines the stop value of the stimulus. (**STOP**; Query)

Sets the stop frequency of a segment. (**STOP** under **MENU**; Query)

value 5 (Hz) to 500 (MHz).
 -50 (dBm) to +15 (dBm).

suffix Refer to "Suffix".

STPSIZE *value [suffix]*

Specifies the frequency step for the list sweep. (**STEP SIZE** under **MENU**; Query)

value 0 to 499.999995 (MHz).

suffix Hz or MHz.

SVCO

Saves the modified color set. (**SAVE COLORS** under **DISPLAY**)

SWET *value* [s]

Sets the sweep time manually. (**SWEEP TIME** under **MENU**); Query)

value 6.0E-4 (s) to 86400 (s).

SWETAUTO

Sets the sweep time automatically. (**SWEEP TIME AUTO** under **MENU**); Query)

SWPT *parameter*

Selects the sweep type. (Query)

parameter LINF, LOGF, LIST, or POWE

SWR

Selects the SWR display for the active channel. (**SWR** under **FORMAT**); Query)

TERI *value* [ohm]

Specifies the (arbitrary) impedance of the standard. (**TERMINAL IMPEDANCE** under **CAL**)

value 0 to 10000 (ohm).

TESC

Continues the test. (Under **SERVICE MENU** under **SYSTEM**)

TESS?

Outputs the test set identifier: 1 for an S-parameter test set, or 0 for none.

TEST *value*

Selects the test number. (Under **SERVICE MENU** under **SYSTEM**); Query)

value 0 to 85.

TINT *value*

Adjusts the hue of the chosen attribute. (**TINT** under **DISPLAY**; Query)

value 0 to 100.

TITL *string*

Sends the string to the title area on the display. (**TITLE** under **DISPLAY**; Query)

string up to 53 characters.

TRACK{ON|OFF}

Tracks the search at the specified target value with each new sweep. (**TRACKING on off** under **MKR FCTN**; Query)

TRAD

Completes the transmission part of the full 2-port calibration. (**TRANS. DONE** under **CAL**)

TRAN

Begins the transmission part of the full 2-port calibration. (**TRANSMISSION** under **CAL**)

VELOFACT *value*

Enters the velocity factor used by the HP 8751A to calculate the equivalent electrical length. (**VELOCITY FACTOR** under **CAL**; Query)

value 0 to 10.

WIDSIN

Searches the cutoff point on the trace within the current cutoff points. (**SEARCH IN** under **MKR FCTN**)

WIDSOUT

Searches the cutoff point on the trace outside of the current cutoff points. (**SEARCH OUT** under **MKR FCTN**)

WIDT{ON|OFF}

Sets the bandwidth search feature (ON) or not (OFF). (**WIDTHS on off** under **MKR FCTN**); Query)

WIDV *value* [*suffix*]

Sets the amplitude parameter that defines the start and stop points for a bandwidth search. (**WIDTH VALUE** under **MKR FCTN**); Query)

value -5.0E+5 (dB) to 5.0E+5 (dB) (Log mag format),
 -5.0E+5 (deg) to 5.0E+5 (deg) (Phase and Expanded phase formats),
 -5.0E+5 (s) to 5.0E+5 (s) (Delay format),
 -5.0E+5 (ohm) to 5.0E+5 (ohm) (Smith chart and Inv. Smith chart
 formats),
 -5.0E+5 (Units) to 5.0E+5 (Units) (Polar, Lin mag, Real, and Imaginary
 formats), or
 -5.0E+5 to 5.0E+5 (SWR format).

suffix Refer to "Suffix".

*CLS

Clears the status byte register, the event register of the standard operation status register structure, and the standard event status register.

*ESE *value*

Sets the enable bits of the standard status register. (Query)

value 0 to 255 (decimal expression of enable bits of the operation status register).

*ESR?

Returns the contents of the standard event status register.

*IDN?

Returns the HP 8751A ID. (Data format: manufacturer, model, serial no., firmware rev.)

*OPC

Tells the HP 8751A to set bit 0 (Operation Complete bit) in the standard event status register when it completes all pending operations. (Query)

***PCB value**

Specifies the address of a controller that is temporarily passing control of the HP-IB to the HP 8751A. (Option 002 only)

value 0 to 30.

***RST**

Resets the HP 8751A to its initial settings.

***SRE value**

Sets the enable bits of the status byte register. (Query)

value 0 to 255 (decimal expression of enable bits of the status byte register).

***STB?**

Reads the status byte by reading the master summary status bit.

***TRG**

Triggers the HP 8751A when the trigger mode is set to the external trigger.

***TST?**

Executes an internal self-test and returns the test result.

***WAI**

Makes the HP 8751A wait until all previously sent commands are completed.

HP-IB Commands Summary

This appendix summarizes the HP-IB commands of the HP 8751A according to the softkey labels.

Active Channel Block

CHAN1	CH 1
CHAN2	CH 2

Response Function Block

MEAS Key

Input Port Menu

AR	A/R
BR	B/R
AB	A/B
MEASA	A
MEASB	B
MEASR	R

S-Parameter Menu

S11	Refl: FWD S11 (A/R)
S21	Trans: FWD S21 (B/R)
S12	Trans: REV S12 (A/R)
S22	Refl: REV S22 (B/R)
BDC	Bdc
BDCR	Bde/R

MEAS *parameter*

Conversion Menu

CONVOFF	OFF
CONVZREF	Z: Refl
CONVZTRA	Z: Trans
CONVYREF	Y: Refl
CONVYTRA	Y: Trans
CONV1DS	1/S
CONV parameter	

FORMAT Key

Format Menu

LOGM	LOG MAG
PHAS	PHASE
DELA	DELAY
SMIC	SMITH CHART
POLA	POLAR
LINM	LIN MAG
SWR	SWR

Format More Menu

REAL	REAL
IMAG	IMAGINARY
EXPP	EXPANDED PHASE
INVSCHAR	INV SMITH CHART
LOGMP	LOG MAG & PHASE
LOGMD	LOG MAG & DELAY
FMT parameter	

SCALE REF Key

Scale Reference Menu

AUTO	AUTO SCALE
SCAL value	SCALE/DIV
REFP value	REFERENCE POSITION
REFV value	REFERENCE VALUE
MARKREF	MARKER — REFERENCE
SCAFDATA	SCALE FOR [DATA]
SCAFMEMO	SCALE FOR [MEMORY]

SCAC D&M SCALE [COUPLE]
 SCAU D&M SCALE [UNCOUPLE]

Electrical Delay Menu

MARKDELA MARKER → DELAY
 ELED *value* ELECTRICAL DELAY
 PHAO *value* PHASE OFFSET
 CONPDISP{ON|OFF} CONJ.P DISP on off

DISPLAY Key

Display Menu

DUAC{ON|OFF} DUAL CHAN on off
 SPLD{ON|OFF} SPLIT DISP on off
 TITL *string* TITLE

Display More Menu

BEEPDONE{ON|OFF} BEEP DONE on off
 BEEPWARN{ON|OFF} BEEP WARN on off
 FREQ FREQUENCY BLANK

Display Allocation Menu

DISAALLI ALL INSTRUMENT
 DISAHIHB HALF INSTR HALF BASIC
 DISAALLB ALL BASIC
 DISA *parameter*

Trace Math Menu

DISPDATA DISPLAY: DATA
 DISPMEMO MEMORY
 DISPDATM DATA and MEMORY
 DISPDDM DATA/MEM
 DISPDMM DATA-MEM
 DATI DATA → MEM
 DISP *parameter*

Conjugate Matching Menu

CONM{ON|OFF} CONJ MATCH on off
 CALP CALCULATE PARAMETERS
 CONPLS *value* PARAMETER: Ls

CONPLP *value* Lp
CONPCS *value* Cs
CONPCP *value* Cp

Select Circuit Menu

SELCLSLP Ls-Lp
SELCLSCP Ls-Cp
SELCCSLP Cs-Lp
SELCCSCP Cs-Cp
SELCLPLS Lp-Ls
SELCLPCS Lp-Cs
SELCCPLS Cp-Ls
SELCCPCS Cp-Cs

SELC *parameter*

Adjust Display Menu

INTE *value* INTENSITY
BACI *value* BACKGROUND INTENSITY
DEFC DEFAULT COLORS
SVCO SAVE COLORS
RECC RECALL COLORS

Modify Colors Menu

COLOCH1D CH1 DATA
COLOCH1M CH1 MEM LIMIT LN
COLOCH2D CH2 DATA
COLOCH2M CH2 MEM LIMIT LN
COLOGRAT GRATICULE
COLOWARN WARNING
COLOTEXT TEXT
COLOIBT

Color Adjust Menu

TINT *value* TINT
CBRI *value* BRIGHTNESS
COLOR *value* COLOR
RSCO RESET COLOR

AVG Key

Average Menu

AVERREST	AVERAGING RESTART
AVERFACT <i>value</i>	AVERAGING FACTOR
AVER{ON OFF}	AVERAGING on off
SMOOPAPER <i>value</i>	SMOOTHING APERTURE
SMOO{ON OFF}	SMOOTHING on off
GRODAPER <i>value</i>	GROUP DELAY APERTURE
IFBW <i>value</i>	IF BW

IF Bandwidth Menu

IFBWAUTO	IF BW AUTO
----------	------------

CAL Key

Correction Menu

CORR{ON OFF}	CORRECTION on off
RESC	RESUME CAL SEQUENCE

Select Cal Kit Menu

CALK7MM	CAL KIT: 7mm
CALKN50	N 50 Ω
CALKN75	N 75 Ω
CALKUSED	USER KIT
MODI1	MODIFY
SAVEUSEK	SAVE USER KIT
CALK <i>parameter</i>	

Calibrate More Menu

VELOFACT <i>value</i>	VELOCITY FACTOR
SETZ <i>value</i>	SET Z0

Reference Plane Menu

PORE{ON OFF}	EXTENSIONS on off
PORTR <i>value</i>	EXTENSION INPUT R
PORTA <i>value</i>	EXTENSION INPUT A
PORTB <i>value</i>	EXTENSION INPUT B
PORT1 <i>value</i>	EXTENSION PORT 1
PORT2 <i>value</i>	EXTENSION PORT 2

DC Correction Menu

DCCOR{ON|OFF} DC CORR on off
EXEDCALI EXECUTE DC CAL
ABODCALI ABORT DC CAL

Calibration Menu

CALN CALIBRATE: NONE
CALIRESP RESPONSE
CALIRAI RESPONSE & ISOL'N
CALIS111 S11 1-PORT
CALIS221 S22 1-PORT
CALIFUL2 FULL 2-PORT
CALIONE2 ONE-PATH 2-PORT
CALI *parameter*

Response Cal Menu

RESPDONE DONE: RESPONSE

Response and Isolation Cal Menu

RAIRESP RESPONSE
RAIISOL ISOL'N STD
RAID DONE RESPONSE ISOL'N CAL

S11 and S22 1-Port Cal Menus

CLASS11A [S11] : OPEN
CLASS11B SHORT
CLASS11C LOAD
CLASS22A [S22] : OPEN
CLASS22B SHORT
CLASS22C LOAD
SAV1 DONE: 1-PORT CAL
STAN{A-G} OPEN[M], OPEN[F], SHORT[M], SHORT[F], load1, load2, and so on.
DONE DONE: OPENS, DONE: SHORTS, or DONE: LOADS

Full 2-Port Cal Menus

REFL REFLECT'N
TRAN TRANSMISSION
ISOL ISOLATION
CLASS11A [S11] : OPEN
CLASS11B SHORT

CLASS11C	LOAD
CLASS22A	[S22] : OPEN
CLASS22B	SHORT
CLASS22C	LOAD
REFD	REFLECT'N DONE
FWDT	FWD. TRANS. THRU
FWDM	FWD. MATCH THRU
REVT	REV. TRANS. THRU
REVM	REV. MATCH THRU
STAN{A-G}	OPEN[M], OPEN[F], SHORT[M], load1, load2, thru1, thru2, and so on.
TRAD	TRANS. DONE
OMII	OMIT ISOLATION
FWDI	FWD. ISOL'N ISOL'N STD
REVI	REV. ISOL'N ISOL'N STD
ISOD	ISOLATION DONE
DONE	DONE: OPENS, DONE: SHORTS, or DONE: LOADS

One-Path 2-Port Cal Menus

REFL	REFLECT'N
TRAN	TRANSMISSION
ISOL	ISOLATION
CLASS11A	[S11] : OPEN
CLASS11B	SHORT
CLASS11C	LOAD
REFD	REFLECT'N DONE
FWDT	FWD. TRANS. THRU
FWDM	FWD. MATCH THRU
OMII	OMIT ISOLATION
FWDI	FWD. ISOL'N ISOL'N STD
STAN{A-G}	open1, open2, short1, short2, load1, load2, thru1, thru2, and so on.
ISOD	ISOLATION DONE
SAV2	DONE: 2-PORT CAL
DONE	DONE: OPENS, DONE: SHORTS, or DONE: LOADS

Modify Cal Kit Menu

DEFS <i>value</i>	DEFINE STANDARD
LABK <i>string</i>	LABEL KIT

KITD

KIT DONE

Define Standard Menus

STDTOPEN	OPEN
STDTSHOR	SHORT
STDTLOAD	LOAD
STDTDELA	DELAY/THRU
STDTARBI	ARBITRARY IMPEDANCE
CO value	CO
C1 value	C1
C2 value	C2
TERI value	TERMINAL IMPEDANCE
LABS string	LABEL STD
STDD	STD DONE (DEFINED)
STDT parameter	

Specify Offset Menu

OFSD parameter	OFFSET DELAY
OFSL parameter	OFFSET LOSS
OFSZ parameter	OFFSET ZO

Specify Class Menus

SPECS11A	SPECIFY: S11A
value,value, ...	
SPECS11B	S11B
value,value, ...	
SPECS11C	S11C
value,value, ...	
SPECS22A	SPECIFY: S22A
value,value, ...	
SPECS22B	S22B
value,value, ...	
SPECS22C	S22C
value,value, ...	
SPECFWDT	FWD TRANS
value,value, ...	
SPECREVT	REV TRANS
value,value, ...	
SPECFWDM	FWD MATCH
value,value, ...	
SPECREVM	REV MATCH
value,value, ...	
SPECRESP	RESPONSE
value,value, ...	

SPECRESI	RESPONSE & ISOL'N
<i>value,value,...</i>	
CLAD	CLASS DONE (SPE'D)

Label Class Menus

LABES11A	LABEL: S11A
LABES11B	S11B
LABES11C	S11C
LABES22A	LABEL: S22A
LABES22B	S22B
LABES22C	S22C
LABEFWDT	LABEL: FWD. TRANS.
LABEREVT	REV. TRANS.
LABEFWDM	FWD. MATCH
LABEREVM	REV. MATCH
LABERESP	RESPONSE
LABERESI	RESPONSE & ISOL'N

(MKR) Key

Marker Menu

MARKOFF	ALL MKR OFF
MARKODATA	MARKERS ON [DATA]
MARKOMEMO	MARKERS ON [MEMORY]
MARKL{ON OFF}	MKR LIST on off
MARKZERO	MKR ZERO

Active Marker Menu

MARK{1-8} <i>value</i>	MARKER 1 to 8
------------------------	---------------

Clear Marker Menu

CLEM{1-8}	MARKER 1 to 8
-----------	---------------

Delta Marker Mode Menu

DELRFIXM	ΔREF=Δ FIXED MKR
DELO	Δ MODE OFF

Delta Marker Menu

DELRL{1-8}	Δ REF=1 to Δ REF=8
------------	--------------------

Fixed Marker Menu

MARKFSTI <i>value</i>	FIXED MKR STIMULUS
MARKFVAL <i>value</i>	FIXED MKR VALUE
MARKFAUV <i>value</i>	FIXED MKR AUX VALUE

Marker Mode Menu

MARKDISC	MARKERS: DISCRETE
MARKCONT	CONTINUOUS
MARKCOUP	MARKERS: COUPLED
MARKUNCO	UNCOUPLED
MARKTIME{ON OFF}	MKR TIME on off

Polar Marker Menu

POLMLIN	LIN MKR
POLMLOG	LOG MKR
POLMRI	Re/Im MKR
POLM <i>parameter</i>	

Smith Marker Menu

SMIMLIN	LIN MKR
SMIMLOG	LOG MKR
SMIMRI	Re/Im MKR
SMIMRX	R+jX MKR
SMIMGB	G+jB MKR
SMIM <i>parameter</i>	

MKR FCTN Key

Marker Function Menu

MARKSTAR	MARKER → START
MARKSTOP	MARKER → STOP
MARKCENT	MARKER → CENTER
MARKSPAN	MARKER → SPAN
MARKREF	MARKER → REFERENCE
MEASTAT{ON OFF}	STATISTICS

Search Range Menu

SEARSTOR	SEARCH RNG STORE
PARS{ON OFF}	PART SRCH on off

Marker Search Menu

SEAOFF	SEARCH: OFF
SEAMAX	MAX
SEAMIN	MIN
SEATARG <i>value</i>	TARGET
TRACK{ON OFF}	TRACKING on off

Target Menu

SEATARG	TARGET
SEAL	SEARCH LEFT
SEAR	SEARCH RIGHT

Marker Search More Menu

SEAMEAN	SEARCH: MEAN
SEALMAX	LOCAL MAX
SEALMIN	LOCAL MIN
SEAPPEAK	PEAK-PEAK
MARKPEAD	MARKER → PEAK DEF
PEADX <i>value</i>	PEAK DEF: ΔX
PEADY <i>value</i>	ΔY
SEAM <i>parameter</i>	

Width Menu

WIDV <i>value</i>	WIDTH VALUE
WIDSIN	SEARCH IN
WIDSOUT	SEARCH OUT
WIDT{ON OFF}	WIDTHS on off

ATTEN Key

ATTIA0DB	INPUT-A: 0dB
ATTIA20DB	20dB
ATTIB0DB	INPUT-B: 0dB
ATTIB20DB	20dB
ATTIRODB	INPUT-R: 0dB
ATTIR20DB	20dB

Stimulus Function Block

STAR <i>value</i>	START
STOP <i>value</i>	STOP
CENT <i>value</i>	CENTER
SPAN <i>value</i>	SPAN

MENU Key

Stimulus Menu

POWE <i>value</i>	POWER
POIN <i>value</i>	NUMBER of POINTS
REST	MEASURE RESTART
COUC{ON OFF}	COUPLED CH on off
CWFREQ <i>value</i>	CW FREQ

Power Menu

POWE <i>value</i>	POWER
CLEPTRIP	CLEAR POWER TRIP
ATTP1 <i>value</i>	ATTENUATOR PORT 1
ATTP2 <i>value</i>	ATTENUATOR PORT 2

Sweep Time Menu

SWET <i>value</i>	SWEEP TIME
SWETAUTO	SWEEP TIME AUTO

Trigger Menu

HOLD	HOLD
SING	SINGLE
NUMG	NUMBER OF GROUPS
CONT	CONTINUOUS
EXTTOFF	TRIGGER: TRIG OFF
EXTTON	EXT. TRIG ON SWEEP
EXTTPOIN	EXT. TRIG ON POINT
MANTRIG	MANUAL TRG ON POINT
EXTT <i>parameter</i>	

Sweep Type Menu

LINFREQ	LIN FREQ
LOGFREQ	LOG FREQ
LISFREQ	LIST FREQ [LIST 1] or LIST FREQ [LIST 2]

POWS	POWER SWEEP
LISDFBASE	LIST DISP: FREQ BASE
LISDOBASE	ORDER BASE
EDITLIST	EDIT LIST
SWPT <i>parameter</i>	

List Sweep Menu

LISSLIS1	SWEEP by: LIST 1
LISSLIS2	LIST 2

Edit List Menu

EDITLIS1	EDIT: LIST 1
EDITLIS2	LIST 2
SEDI <i>value</i>	SEGMENT
SDEL	DELETE
SADD	ADD
CLEL	CLEAR LIST
EDITDONE	LIST DONE

Edit Segment Menu

MARKSTAR	MKR — START
MARKSTOP	MKR — STOP
POINT	NUMBER of POINTS
STPSIZE <i>value</i>	STEP SIZE
POWE <i>value</i>	POWER
IFBW <i>value</i>	IF BW
SDON	SEGMENT DONE

Edit Segment More Menu

STAR <i>value</i>	SEGMENT: START
STOP <i>value</i>	STOP
CENT <i>value</i>	CENTER
SPAN <i>value</i>	SPAN

Clear List Menu

CLEL	CLEAR LIST YES
------	----------------

Instrument State Function Block

SYSTEM Key

Real Time Clock Menu

SETCTIME	TIME HH:MM:SS
<i>hour, min, sec</i>	
SETCDATE	DATE MM:DD:YY
<i>year, month, day</i>	
MONDYEAR	DATE MODE: MonDayYear
DAYMYEAR	DayMonYear

Limits Menu

LIMILINE{ON OFF}	LIMIT LINE on off
LIMITEST{ON OFF}	LIMIT TEST on off
BEEPFAIL{ON OFF}	BEEP FAIL on off
EDITLIML	EDIT LIMIT LINE

Edit Limits Menu

LIMSEDI <i>value</i>	EDIT
LIMSDEL	DELETE
LIMSADD	ADD
LIMEDONE	DONE

Edit Segment Menu

LIMS <i>value</i>	STIMULUS VALUE
MARKSTIM	MARKER → STIMULUS
LIMU <i>value</i>	UPPER LIMIT
LIML <i>value</i>	LOWER LIMIT
LIMD <i>value</i>	DELTA LIMITS
LIMM <i>value</i>	MIDDLE VALUE
MARKMIDD	MARKER → MIDDLE
LIMEDONE	DONE

Clear List Menu

LIMCLEL	CLEAR LIST YES
---------	----------------

Offset Limit Menu

LIMISTIO <i>value</i>	STIMULUS OFFSET
LIMIAMPO <i>value</i>	AMPLITUDE OFFSET

LIMIMAOF MARKER → AMP. OPS

LOCAL Key

ADDRPLOT *value* ADDRESS: PLOTTER
ADDRPRIN *value* ADDRESS: PRINTER
ADDRCONT *value* ADDRESS: CONTROLLER

PRESET Key

PRES PRESET

COPY Key

Copy Menu

PRINALL PRINT [STANDARD]
PLOT PLOT
COPA COPY ABORT
COPT{ON|OFF} COPY TIME on off

Print/Plot Setup Menu

PRIS PRINT: STANDARD
PRIC COLOR
PRICFIXE PRINT COLOR [FIXED]
PRICVARI PRINT COLOR [VARIABLE]
DFLT DEFAULT SETUP

Select Quadrant Menu

LEFU LEFT UPPER
LEFL LEFT LOWER
RIGU RIGHT UPPER
RIGL RIGHT LOWER
FULP FULL PAGE

QUAD *parameter*

Define Plot Menu

PLOALL PLOT: ALL
PLODGRATY DATA & GRATICL
PLODONL DATA ONLY
LINTDATA LINE TYPE DATA
LINTMEMO LINE TYPE MEMORY

PLOFAST PLOT SPEED [FAST]
PLOSSLOW PLOT SPEED [SLOW]
PLOC *parameter*

Scale Plot Menu

SCAPFULL SCALE: FULL
SCAPGU UPPER GRATICULE
SCAPGL LOWER GRATICULE

Copy More Menu

LISV LIST VALUES
OPEP OPERATING PARAMETERS

Copy Cal Kit Menu

CALCASSI CLASS ASSIGNMENT

Copy Standard Number Menu

CALS *value* STD NO. 1 to STD NO. 8

Copy List Sweep Menu

DISL1 DISPLAY: LIST1
DISL2 LIST2
DISMSTSP DISP MODE: ST & SPAN
DISMNUM NUMBER of POINTS
DISMSTEP STEP SIZE

Copy Limit Test Menu

DISLLIST DISPLAY LIST
DISMUL DISP MODE: UPR & LWR
DISMMD MID & DLT

Screen Menu

PRINALL PRINT [STANDARD]
PLOT PLOT
COPA COPY ABORT
COPT{ON|OFF} COPY TIME on off
NEXP NEXT PAGE
PREP PREV PAGE
RESD RESTORE DISPLAY

SAVE and **RECALL** Keys

Save Menu

RESAVD *string* **RE-SAVE FILE**

Define Save Menu

SAVDALL *string* **SAVE ALL**

SAVDSTA *string* **SAVE STATE ONLY**

SAVDDAT *string* **SAVE DATA ONLY**

Define Save Date Menu

SAVRA{ON|OFF} **RAW ARY on off**

SAVCA{ON|OFF} **CAL ARY on off**

SAVDA{ON|OFF} **DATA ARY on off**

SAVMA{ON|OFF} **MEMORY ARY on off**

SAVUA{ON|OFF} **UNFORM ARY on off**

SAVTA{ON|OFF} **TRACE ARY on off**

SAVTMA{ON|OFF} **T.MEM ARY on off**

Disk Menu

PURG *string* **PURGE FILE**

INID **INITIALIZE DISK**

Recall Menu

RECD *string* **RECALL FILE**

Service Function

TEST *value*

EXET

TESC

DESTON

DESTOFF

SELD

FIRR?

RECCON

RECCOFF

SOUCON

SOUCOFF

DCBUS *value*

FBUS *value*

FVNNORM

FNVOPEN
FNDAUTO
FNDMANU
FNDVALU *value*
STEONORM
STEOOPEN
STEODAUT
STEODMAN
STEODVAL *value*
REOPNORM
REOPOPEN
FIRLPNOR
FIRLPOPE
MIXLPNOR
MIXLPTES
POWDAUTO
POWDMANU
POWDVALU *value*
POWLANOR
POWLAOPE
ACTLNORM
ACTLHFRE
ACTLLFRE
FIRLANOR
FIRLAOPE
CHAIRANG
IFRCH?
IFRAUTO
IFRX1
IFRX8X1
IFRX1X8
IFRX64
OUTPFBUS?
OUTPTESS? *value*
EXTRLOCK?

Commands Which Don't Have Equivalent Softkey Labels

INP8IO
OUT8IO *value*
OUTPINP8IO
MARKBUCK *value*
PSOFT{ON|OFF}
KEY *value*
INPUDATA *value*
INPUFORM *value*
INPUUFORM *value*
INPURAW1 *value*
INPURAW2 *value*
INPURAW3 *value*
INPURAW4 *value*
INPUCALC{01-12} *value*
INPUCALK *value*
FORM2
FORM3
FORM4
FORM5
OUTPCALC{01-12}?
OUTPCALK?
OUTPSTIM?
OUTPDATA?
OUTPDATAP? *value*
OUTPERRO?
OUTPFORM?
OUTPFORMP? *value*
OUTPLIMF?
OUTPFAIP?
OUTPLIML?
OUTPLIMM?
OUTPMARK?
OUTPMEMO?
OUTPMEMOP? *value*
OUTPTMEM?
OUTPTMEMP? *value*
OUTPIFORM?
OUTPITMEM?
OUTPRFORM?
OUTPRTMEM?
OUTPIRFORM?
OUTPIRTMEM?
OUTPUFORM?
OUTPMSTA?
OUTPMWID?
OUTPRAW1?
OUTPRAW2?
OUTPRAW3?

OUTPRAW4?
OUTPTITL?
ESB?
ESNB *value*
OSR?
OSE *value*
TESS?
CLES
SAVC

IEEE 488.2 Common Commands

*IDN?
*RST
*TST?
*OPC
*OPC?
*WAI
*CLS
*ESE *value*
*ESE?
*ESR?
*SRE *value*
*SRE?
*STB?
*TRG
*PCB *value*

Status Reporting

Figure B-1 shows the status reporting structure of the HP 8751A. Table B-1, Table B-2, Table B-3, and Table B-4 describe the status bits of each register.

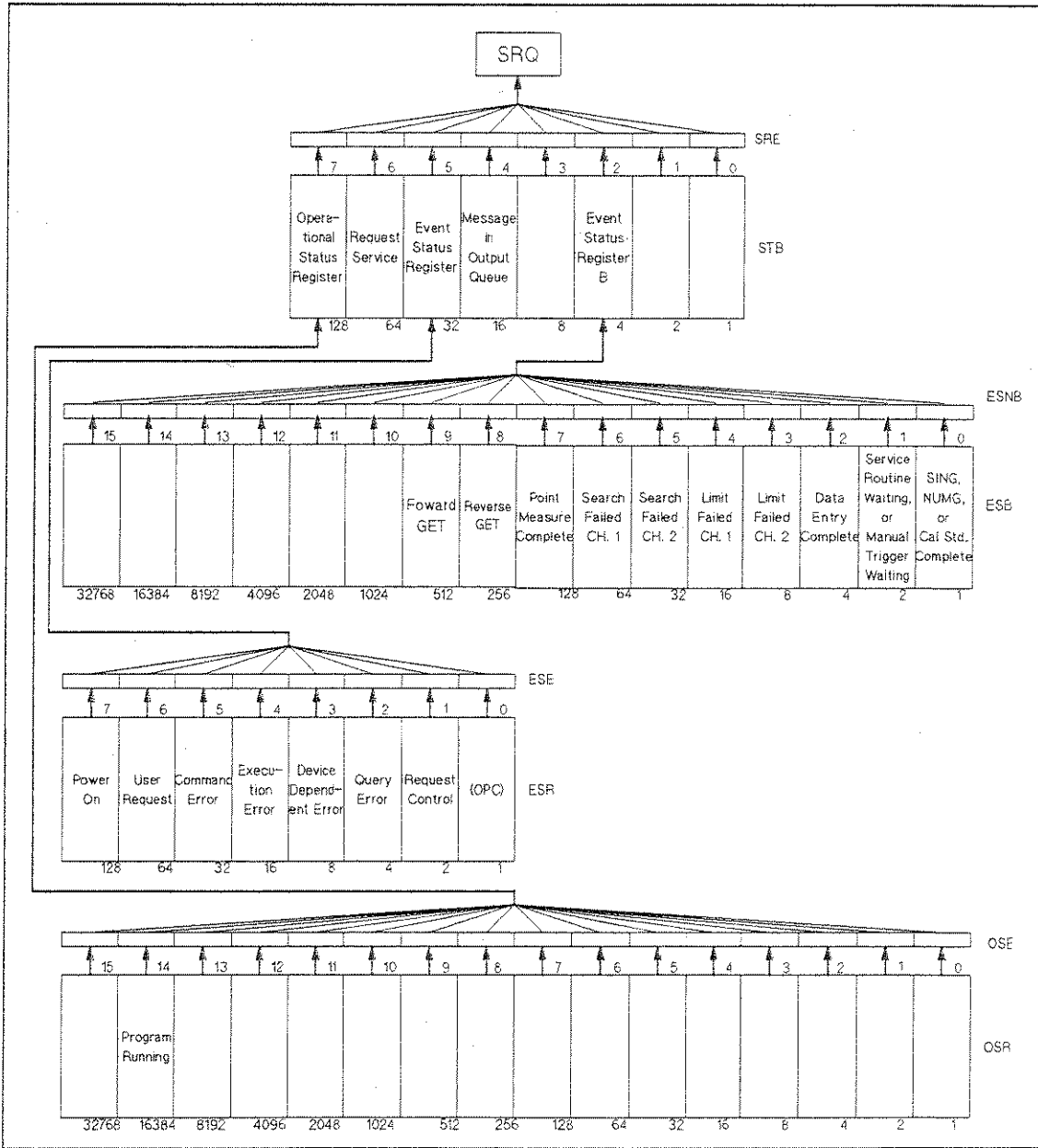

CSAB001

Figure B-1. Status Reporting Structure

Table B-1. Status Bit Definitions of the Status Byte (STB)

Bit	Name	Description
2	Check event status register B	One of the enabled bits in event status register B has been set.
4	Message in output queue	A command has prepared information to be output, but it has not been read yet.
5	Check event status register	One of the enabled bits in the event status register has been set.
6	Request service	One of the enabled status byte bits is causing an SRQ.
7	Operational status summary bit	One of the enabled bits in the operational status register has been set.

Table B-2. Status Bit Definitions of the Event Status Register (ESR)

Bit	Name	Description
0	Operation complete	A command for which OPC has been enabled and completed an operation.
1	Request control	The HP 8751A has been commanded to perform an operation that requires control of a peripheral, and needs control of HP-IB.
2	Query error	<ol style="list-style-type: none"> 1. The HP 8751A has been addressed to talk, but there is nothing in the output queue to transmit. 2. Data in the Output Queue has been lost.
3	Device dependent error	An error other than a command error, a query error, and an execution error has occurred.
4	Execution error	<ol style="list-style-type: none"> 1. A program data element following a header exceeded its input range, or is inconsistent with the HP 8751A's capabilities. 2. A valid program message could not be properly executed due to some instrument condition.
5	Command error	<ol style="list-style-type: none"> 1. An IEEE 488.2 syntax error has been occurred. Possible violations include, a data element violated the HP 8751A listening formats or a data element type is unacceptable to the HP 8751A. 2. A semantic error which indicates that an unrecognized header was received has occurred. Unrecognized headers include incorrect device-specific headers and incorrect or unimplemented IEEE 488.2 common commands. 3. A Group Execute Trigger (GET) was entered into the Input Buffer of a program message.
6	User request	The operator has pressed a front panel key or an optional keyboard key or turned the rotary knob.
7	Power on	A power on sequence has occurred since the last read of the register.
8	Waiting for reverse GET	A one-path 2-port calibration is active, and the instrument has stopped, waiting for the operator to connect the device for a reverse measurement.
9	Waiting for forward GET	A one-path 2-port calibration is active, and the instrument has stopped, waiting for the operator to connect the device for a forward measurement.

Table B-3. Status Bit Definitions of the Event Status Register B (ESB)

Bit	Name	Description
0	Sweep or group complete	A single sweep or group has been completed since the last read of the register. Operates in conjunction with SING or NUMG.
1	Service routine waiting or done, or manual trigger waiting	<ol style="list-style-type: none"> 1. An internal service routine has completed an operation, or is waiting for an operator response. 2. The HP 8751A has set the manual trigger on point mode and is waiting for a manual trigger.
2	Data entry complete	A terminator key has been pressed.
3	Limit failed, Ch 2	Limit test failed on channel 2.
4	Limit failed, Ch 1	Limit test failed on channel 1.
5	Search failed, Ch 2	A marker search was executed on channel 2, but the target value was not found.
6	Search failed, Ch 1	A marker search was executed on channel 1, but the target value was not found.
7	Point measurement complete ¹	One point measurement of a sweep has completed.

¹ This bit is set only when the related bits of both the SRE and ESNB are enabled.

In the case of the manual trigger on point mode, HP 8751A accepts the next trigger while current measurement is in progress (up to the number of points). Use bit 1 and bit 7 correctly to synchronize measurement and external triggering. For example, 1) wait until bit 1 is set, 2) trigger, and 3) wait until bit 7 is set.

Table B-4. Status Bit Definitions of the Operational Status Register (OSR)

Bit	Name	Description
14	Program running	An HP Instrument BASIC program is running.

Key Codes

Figure C-1 shows the codes of the front panel keys for using the KEY HP-IB command.

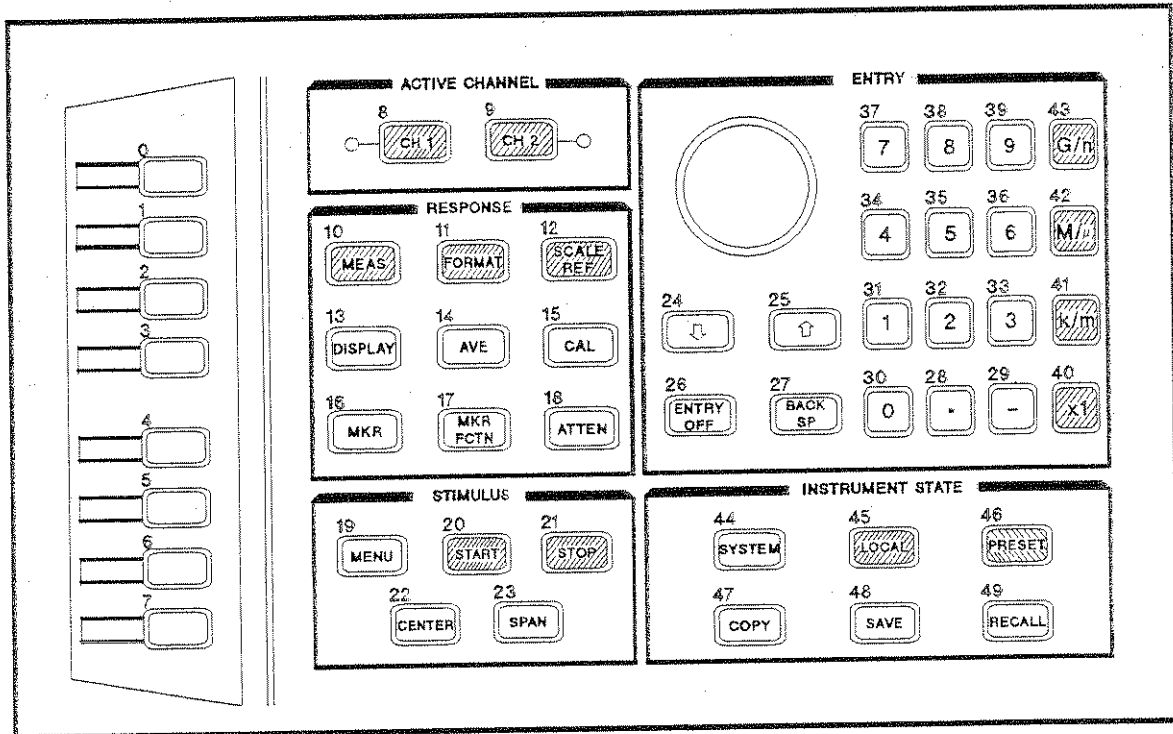

C25AC001

Figure C-1. Key Codes

Calibration Types and Standard Classes, and Calibration Arrays

Table D-1 lists which standard classes are required for each calibration type. Table D-2 specifies where the calibration coefficients are stored for different calibration types.

Table D-1. Calibration Types and Standard Classes

Class	Response	Response and Isolation	S ₁₁ 1-port	S ₂₂ 1-port	One-path 2-port	Full 2-port
Response:	•					
Response and isolation:						
Response		•				
Isolation		•				
Reflection: ¹					•	•
S11A (opens)			•		•	•
S11B (shorts)			•		•	•
S11C (loads)			•		•	•
S22A (opens)				•		•
S22B (shorts)				•		•
S22C (loads)				•		•
Transmission: ¹					•	•
Forward match					•	•
Forward thru					•	•
Reverse match						•
Reverse thru						•
Isolation: ¹					•	•
Forward					•	•
Reverse						•

¹ These subheadings must be called when doing 2-port calibrations.

Table D-2. Calibration Array

Array	Response ¹	Response and Isolation ¹	1-port ¹	2-port ^{1,2}
1	E _R or E _T	E _X (E _D) ³ E _T (E _R)	E _D	E _{DF}
2			E _S	E _{SF}
3			E _R	E _{RF}
4				E _{XF}
5				E _{LF}
6				E _{TF}
7				E _{DR}
8				E _{SR}
9				E _{RR}
10				E _{XR}
11				E _{LR}
12				E _{TR}

1 Meaning of first subscript: D=directivity; S=source match; X=crosstalk; L=load match; T=transmission tracking.

Meaning of second subscript: F=forward; R=reverse.

2 One path, 2-port cal duplicates arrays 1 to 6 in arrays 7 to 12.

3 Response and isolation corrects for crosstalk and transmission tracking in transmission measurements, and for directivity and reflection tracking in reflection measurements.

Error Messages

This section lists the error messages that may be displayed on the analyzer display or transmitted by the instrument over HP-IB. Each error message is accompanied by an explanation, and suggestions are provided to help in solving the problem. Where applicable, references are given to related sections of the Operation and Maintenance manuals.

When displayed, error messages are usually preceded with the word CAUTION:. That part of the error message has been omitted here for the sake of brevity. Some messages are for information only, and do not indicate an error condition. Two listings are provided: the first is in alphabetical order, and the second in numerical order.

In addition to error messages, instrument status is indicated by status notations in the left margin of the display. Examples are "+", "mSH", and "P↓". Sometimes these appear in conjunction with error messages. A complete listing of status and notations and their meanings is provided in "Front and Rear Panel" in the *Reference Manual*.

ERROR MESSAGES IN ALPHABETICAL ORDER

159 +12V OUT OF SPEC

Severe error. Contact your nearest Hewlett-Packard office.

160 +15V(A) OUT OF SPEC

Severe error. Contact your nearest Hewlett-Packard office.

157 +18V OUT OF SPEC

Severe error. Contact your nearest Hewlett-Packard office.

161 +22V OUT OF SPEC

Severe error. Contact your nearest Hewlett-Packard office.

162 +65V OUT OF SPEC

Severe error. Contact your nearest Hewlett-Packard office.

156 -12.6V OUT OF SPEC

Severe error. Contact your nearest Hewlett-Packard office.

155 -15V OUT OF SPEC

Severe error. Contact your nearest Hewlett-Packard office.

192 1st IF OFFSET OSC TEST FAILED

Severe error. Contact your nearest Hewlett-Packard office.

190 1st LOCAL AMP TEST FAILED

Severe error. Contact your nearest Hewlett-Packard office.

186 1st LOCAL MIXER LOCAL PORT ALC TEST FAILED

Severe error. Contact your nearest Hewlett-Packard office.

149 A1 CPU EXT BUS TEST FAILED

Severe error. Contact your nearest Hewlett-Packard office.

141 A1 ROM TEST FAILED

Severe error. Contact your nearest Hewlett-Packard office.

A40 HEAT SINK TOO HOT

The temperature sensors on the A4 post-regulator assembly have detected an over-temperature condition. Power off and cool down the instrument for approximately 10 minutes. If this message is displayed again, contact your nearest Hewlett-Packard office.

165 Ach +5V(A)/2 OUT OF SPEC

Severe error. Contact your nearest Hewlett-Packard office.

173 Ach A/D LINEARITY POOR

Severe error. Contact your nearest Hewlett-Packard office.

166 Ach A/D REF VOLTAGE OUT OF SPEC

Severe error. Contact your nearest Hewlett-Packard office.

170 Ach RECEIVER FUNCTIONALLY POOR

Severe error. Contact your nearest Hewlett-Packard office.

176 Ach/Rch IF GAIN OUT OF SPEC

Severe error. Contact your nearest Hewlett-Packard office.

6 ADDITIONAL STANDARD NEEDED

Error correction for the selected calibration class cannot be computed until all the necessary standards have been measured.

14 BACKUP DATA LOST

Data check-sum error on the battery backup memory has occurred. The battery is recharged for approximately 10 minutes after power on.

143 BACKUP RAM TEST FAILED

Severe error. Contact your nearest Hewlett-Packard office.

167 Bch -5.2V(A)/2 OUT OF SPEC

Severe error. Contact your nearest Hewlett-Packard office.

174 Bch A/D LINEARITY POOR

Severe error. Contact your nearest Hewlett-Packard office.

168 Bch A/D REF VOLTAGE OUT OF SPEC

Severe error. Contact your nearest Hewlett-Packard office.

171 Bch RECEIVER FUNCTIONALLY POOR

Severe error. Contact your nearest Hewlett-Packard office.

177 Bch/Rch IF GAIN OUT OF SPEC

Severe error. Contact your nearest Hewlett-Packard office.

-160 Block data error

Block data is improper.

-168 Block data not allowed

Block data is not allowed.

9 CALIBRATION ABORTED

The calibration in progress was terminated due to change of the active channel or stimulus parameters.

7 CALIBRATION REQUIRED

No valid calibration coefficients were found, when user attempted to turn calibration on. Refer to "Measurement Calibration" in the *Reference Manual*.

60 CAN'T CHANGE-ANOTHER CONTROLLER ON BUS

The analyzer cannot assume the mode of system controller until the active controller is removed from the bus or relinquishes the bus.

-148 **Character data not allowed**

Character data not allowed for this operation.

-144 **Character data too long**

Character data is too long (maximum length is 12 characters).

136 **CONTINUOUS SWITCHING NOT ALLOWED**

The current measurement requires the S-parameter test set to switch automatically between forward and reverse measurements (driving test port 1 and, then test port 2). Refer to "Stimulus Function Block" in the *Reference Manual*.

-253 **CORRUPT MEDIA**

A legal program command could not be executed because of corrupt media; for example, bad disk or wrong format.

13 **CURRENT PARAMETER NOT IN CAL SET**

HP-IB only. Correction is not valid for the selected measurement parameter. Refer to "Measurement Calibration" in the *Reference Manual*.

-222 **Data out of range**

Numerical parameter of HP-IB command is out of the range defined.

-104 **Data type error**

Improper data type used (for example, string data was expected, but numeric data was received).

10 **DC CALIBRATION ABORTED**

Pressing the **ABORT DC CAL** softkey causes the analyzer to abort the DC detector linearity calibration in progress.

97 **DC OVERLOAD ON INPUT A**

96 **DC OVERLOAD ON INPUT B**

98 **DC OVERLOAD ON INPUT R**

The DC voltage at one of the three receiver inputs approaches a DC damage level. Refer to "Instrument Specifications" in the *General Information* section for the DC damage level.

-255 **DIRECTORY FULL**

A legal program command could not be executed because the media directory was full.

142 DRAM TEST FAILED

Severe error. Contact your nearest Hewlett-Packard office.

144 EEPROM TEST FAILED

Severe error. Contact your nearest Hewlett-Packard office.

182 EEPROM WRITE FAILED

Severe error. Contact your nearest Hewlett-Packard office.

12 EXCEEDED 7 STANDARDS PER CLASS

A maximum of seven standards can be defined for any class. Refer to "Measurement Calibration" in the *Reference Manual*.

5 EXTERNAL REFERENCE UNLOCKED

The frequency of the external reference signal input to the connector on the rear panel deviates from $10/N$ MHz, where N is an integer between 1 to 10, and phase lock can no longer be maintained. Refer to "Front and Rear Panel" in the *Reference Manual* for details about the signal.

158 FAN POWER OUT OF SPEC

Severe error. Contact your nearest Hewlett-Packard office.

153 FDC CHIP TEST FAILED

Severe error. Contact your nearest Hewlett-Packard office.

-257 FILE NAME ERROR

A legal program command could not be executed because the file name on the device media was in error; for example, an attempt was made to copy to a duplicate file name.

-256 FILE NAME NOT FOUND

A legal program command could not be executed because the file name on the device media was not found; for example, an attempt was made to read or copy a nonexistent file.

191 FN FREQ TEST FAILED

Severe error. Contact your nearest Hewlett-Packard office.

181 FN PRETUNE-DAC/MONITOR FAILURE

Severe error. Contact your nearest Hewlett-Packard office.

61 FORMAT NOT VALID FOR MEASUREMENT

The conversion function except the 1/S mode is not valid for the Smith, Inverse Smith, and SWR formats.

32 **FORMAT TYPE IS NOT SMITH**

The conjugate matching function is only valid in the Smith chart format.

147 **FPC TEST FAILED**

Severe error. Contact your nearest Hewlett-Packard office.

-105 **GET not allowed**

GET is not allowed inside a program message.

150 **GSP I/F TEST FAILED**

Severe error. Contact your nearest Hewlett-Packard office.

154 **HPIB CHIP TEST FAILED**

Severe error. Contact your nearest Hewlett-Packard office.

146 **INTR TIMER TEST FAILED**

Severe error. Contact your nearest Hewlett-Packard office.

-161 **Invalid block data**

Invalid block data was received (for example, END received before length satisfied).

-141 **Invalid character data**

Bad character data or unrecognized character data was received.

-121 **Invalid character in number**

Invalid character in numeric data.

-101 **Invalid character**

Invalid character was received.

104 **INVALID FILE NAME**

HP-IB only. The file name for the RECALL, PURGE, or RE-SAVE function must have a extension, "_A", "_D", or "_S". Refer to "Saving and Recalling Instrument States and Data" in the *Reference Manual* for more information.

-103 **Invalid separator**

The message unit separator (for example, ";", ",", ") is improper.

-151 **Invalid string data**

Invalid string data was received (for example, END received before close quote).

-131 Invalid suffix

Units are unrecognized, or the units are not appropriate.

152 KEY CHIP TEST FAILED

Severe error. Contact your nearest Hewlett-Packard office.

66 LIST TABLE EMPTY OR INSUFFICIENT TABLE

The frequency list is empty. To implement list frequency mode, add segments to the list table. Refer to "Stimulus Function Block" in the *Reference Manual*.

80 LOCAL MAX NOT FOUND

The maximum peak whose sharpness is defined by the peak define function cannot be found.

81 LOCAL MIN NOT FOUND

The minimum peak whose sharpness is defined by the peak define function cannot be found.

-250 MASS STORAGE ERROR

A mass storage error occurred. This error message should be used when the device cannot detect the more specific errors described for errors -251 through -259.

-254 MEDIA FULL

A legal program command could not be executed because the media was full; for example, there is no room on the disk.

-258 MEDIA PROTECTED

A legal program command could not be executed because the media was protected; for example, the write-protect tab on a disk was present.

-251 MISSING MASS STORAGE

A legal program command could not be executed because of missing mass storage; for example, attempt to access an external disk drive by using Instrument BASIC.

-252 MISSING MEDIA

A legal program command could not be executed because of a missing media; for example, no disk.

-109 Missing parameter

A command with improper number of parameters received.

178 MIXER LINEARITY POOR

Severe error. Contact your nearest Hewlett-Packard office.

8 NO CALIBRATION CURRENTLY IN PROGRESS

The **RESUME CAL SEQUENCE** softkey is not valid unless a calibration was already in progress. Start a new calibration. Refer to "Measurement Calibration" in the *Reference Manual*.

111 NO DATA TRACE DISPLAYED

The **SCALE FOR [DATA]** is selected while the data trace is not displayed.

76 NO DATA TRACE

The **MARKER ON [DATA]** is selected while the data trace is not displayed.

105 NO LEGAL FILES ON DISK

There are no files on the disk with extensions, "_A", "_D", or "_S". Refer to "Saving and Recalling Instrument States and Data" in the *Reference Manual* for more information.

82 NO MARKER DELTA - PEAK DEF NOT SET

The **MARKER → PEAK DEF** softkey requires that delta marker mode be turned on, with at least two markers displayed. Refer to "Using Markers" in the *Reference Manual*.

79 NO MARKER DELTA - RANGE NOT SET

The **SEARCH RNG STORE** softkey requires that delta marker mode be turned on, with at least two markers displayed. Refer to "Using Markers" in the *Reference Manual*.

78 NO MARKER DELTA - SPAN NOT SET

The **MARKER → SPAN** softkey requires that delta marker mode be turned on, with at least two markers displayed. Refer to "Using Markers" in the *Reference Manual*.

112 NO MEMORY TRACE DISPLAYED

The **SCALE FOR [MEMORY]** is selected while the memory trace is not displayed.

77 NO MEMORY TRACE

The **MARKER ON [MEMORY]** is selected while the memory trace is not displayed.

117 NO VALID Ach ABS MAG CORRECTION CONSTANTS

Severe error. Contact your nearest Hewlett-Packard office.

118 NO VALID Bch ABS MAG CORRECTION CONSTANTS

Severe error. Contact your nearest Hewlett-Packard office.

122 NO VALID DC FULL SCALE CORRECTION CONSTANTS

Severe error. Contact your nearest Hewlett-Packard office.

125 NO VALID FN PRETUNE CORRECTION CONSTANTS

Severe error. Contact your nearest Hewlett-Packard office.

123 NO VALID HF PWR LIN CORRECTION CONSTANTS

Severe error. Contact your nearest Hewlett-Packard office.

124 NO VALID LF PWR LIN CORRECTION CONSTANTS

Severe error. Contact your nearest Hewlett-Packard office.

30 NO VALID MEMORY TRACE

If a memory trace is to be displayed or otherwise used, a data trace must first be stored to memory. Refer to "Response Function Block" in the *Reference Manual*.

121 NO VALID RATIO A/B CORRECTION CONSTANTS

Severe error. Contact your nearest Hewlett-Packard office.

119 NO VALID RATIO A/R CORRECTION CONSTANTS

Severe error. Contact your nearest Hewlett-Packard office.

120 NO VALID RATIO B/R CORRECTION CONSTANTS

Severe error. Contact your nearest Hewlett-Packard office.

116 NO VALID Rch ABS MAG CORRECTION CONSTANTS

Severe error. Contact your nearest Hewlett-Packard office.

126 NO VALID STEP OSC CORRECTION CONSTANTS

Severe error. Contact your nearest Hewlett-Packard office.

31 NOT AVAILABLE FOR THIS FORMAT

The **D&M SCALE [COUPLED]** softkey is not valid when the format is either LOG MAG & PHASE, or LOG MAG & DELAY.

41 NOT ENOUGH DATA

HP-IB only. The amount of data sent to the analyzer is less than that expected.

11 NOT VALID FOR PRESENT TEST SET

The calibration requested is inconsistent with the test set present. This message occurs in the following situations:

- A full 2-port calibration is requested with a test set other than an S-parameter test set.
- A one-path 2-port calibration is requested with an S-parameter test set (this procedure is typically used with a transmission/reflection test set).

-128 Numeric data not allowed

Numerical data not allowed for this operation.

-123 Numeric overflow

Numerical data value was too large (exponent magnitude >32k).

94 OVERLOAD ON INPUT A, POWER REDUCED

93 OVERLOAD ON INPUT B, POWER REDUCED

95 OVERLOAD ON INPUT R, POWER REDUCED

When the power level at one of the three receiver inputs exceeds a certain level greater than the maximum input level, the RF output power level is automatically reduced to minimum and the annotation "P↓" appears in the left margin of the display. Refer to "Stimulus Function Block" in the *Reference Manual*.

-108 Parameter not allowed

Too many parameters for the command received.

21 PLOT ABORTED

Pressing the **COPY ABORT** softkey causes the analyzer to abort the plot in progress.

25 PLOTTER NOT READY-PINCH WHEELS UP

If user attempts to plot when plotter's pinch wheels are up, this message is displayed.

23 PLOTTER: not on, not connected, wrong address

The plotter does not respond to control. Verify power to the plotter, and check the HP-IB connection between the analyzer and the plotter. Ensure that the plotter address recognized by the analyzer matches the HP-IB address set on the plotter itself. Refer to "Instrument State Function Block" in the *Reference Manual* for instruction on setting peripheral addresses.

180 POOR PRETUNE TRACKING

Severe error. Contact your nearest Hewlett-Packard office.

185 POWER LINEARITY TEST FAILED

Severe error. Contact your nearest Hewlett-Packard office.

POWER SHUT DOWN (ANALOG SYSTEM)

Severe error. Contact your nearest Hewlett-Packard office.

4 POWER SHUT DOWN (FDD, FRONT PANEL)

Severe error. Contact your nearest Hewlett-Packard office.

20 PRINT ABORTED

Pressing the COPY ABORT softkey causes the analyzer to abort the plot in progress.

24 PRINT/PLOT IN PROGRESS, ABORT WITH COPY ABORT

If a print or plot is in progress and a second print or plot is attempted, this message is displayed and the second attempt is ignored. To abort a print or plot in progress, press COPY ABORT.

22 PRINTER: not on, not connected, wrong address

The printer does not respond to control. Verify power to the plotter, and check the HP-IB connection between the analyzer and the printer. Ensure that the printer address recognized by the analyzer matches the HP-IB address set on the printer itself. Refer to "Instrument State Function Block" in the *Reference Manual* for instruction on setting peripheral addresses.

-112 Program mnemonic too long

Program mnemonic is too long (maximum length is 12 characters).

-430 Query DEADLOCKED

Input buffer and output buffer are full; cannot continue.

-400 Query error

Query is improper.

-410 Query INTERRUPTED

Query is followed by DAB or GET before the response was completed.

-440 Query UNTERMINATED after indefinite response

The query which requests arbitrary data response (*IDN? and *OPT? queries) is sent before usual queries in a program message. (for example, `FREQ?; *IDN?` was expected, but `*IDN?; FREQ?` is received.)

-420 Query UNTERMINATED

Addressed to talk, incomplete program message received.

145 RATE TIMER TEST FAILED

Severe error. Contact your nearest Hewlett-Packard office.

163 Rch +5V(D)/2 OUT OF SPEC

Severe error. Contact your nearest Hewlett-Packard office.

172 Rch A/D LINEARITY POOR

Severe error. Contact your nearest Hewlett-Packard office.

164 Rch A/D REF VOLTAGE OUT OF SPEC

Severe error. Contact your nearest Hewlett-Packard office.

169 Rch RECEIVER FUNCTIONALLY POOR

Severe error. Contact your nearest Hewlett-Packard office.

148 REALTIME CLOCK TEST FAILED

Severe error. Contact your nearest Hewlett-Packard office.

REAR PANEL FAN STOPPED

The analyzer detected that the rear panel fan stopped and automatically shut the power down.

103 RECALL ERROR: INSTR STATE PRESET

A serious error, for example corrupted data, is detected on recalling file, and this forced the analyzer to be preset.

184 RF AMP FLATNESS TEST FAILED

Severe error. Contact your nearest Hewlett-Packard office.

187 RF MIXER LOCAL PORT ALC TEST FAILED

Severe error. Contact your nearest Hewlett-Packard office.

193 RF OSC TEST FAILED

Severe error. Contact your nearest Hewlett-Packard office.

189 RF POWER LEVEL ALC(HF) TEST FAILED

Severe error. Contact your nearest Hewlett-Packard office.

188 RF POWER LEVEL ALC(LF) TEST FAILED

Severe error. Contact your nearest Hewlett-Packard office.

102 SAVE ERROR

A serious error, for example physically damaged disk surface, is detected on saving file.

175 SOURCE ATTENUATOR OUT OF SPEC

Severe error. Contact your nearest Hewlett-Packard office.

183 STEP OSC TEST FAILED

Severe error. Contact your nearest Hewlett-Packard office.

-150 String data error

String data is improper.

-158 String data not allowed

String data is not allowed.

-138 Suffix not allowed

A suffix is not allowed for this operation.

-102 Syntax error

Unrecognized command or data type was received.

-124 Too many digits

Numerical data length was too long (more than 255 digits received).

-350 Too many errors

Too many errors occurred in HP-IB commands.

67 TOO MANY SEGMENTS OR POINTS

Frequency list mode is limited to 31 segments or 801 points. Refer to "Stimulus Function Block" in the *Reference Manual* for more information.

50 TOO MANY SEGMENTS

The maximum number of segments for the limit line table is 18. Refer to "Instrument State Function Block" in the *Reference Manual*.

-223 Too much data

Either there is too much binary data to send to the analyzer when data transfer format is FORM 2, FORM 3 or FORM 5, or number of data is greater than the number of points.

40 TOO MUCH DATA

The number of data to be sent to the analyzer is greater than that expected.

-113 Undefined header

Undefined header or an unrecognized command was received (operation not allowed).

179 VCO MISADJUSTED, RETRY THIS TEST

Severe error. Contact your nearest Hewlett-Packard office.

151 VRAM TEST FAILED

Severe error. Contact your nearest Hewlett-Packard office.

ERROR MESSAGES IN NUMERICAL ORDER

POWER SHUT DOWN (ANALOG SYSTEM)

Severe error. Contact your nearest Hewlett-Packard office.

A40 HEAT SINK TOO HOT

The temperature sensors on the A4 post-regulator assembly have detected an over-temperature condition. Power off and cool down the instrument for approximately 10 minutes. If this message is displayed again, contact your nearest Hewlett-Packard office.

REAR PANEL FAN STOPPED

The analyzer detected that the rear panel fan stopped and automatically shut the power down.

4 POWER SHUT DOWN (FDD, FRONT PANEL)

Severe error. Contact your nearest Hewlett-Packard office.

5 EXTERNAL REFERENCE UNLOCKED

The frequency of the external reference signal input to the connector on the rear panel deviates from $10/N$ MHz, where N is an integer between 1 to 10, and phase lock can no longer be maintained. Refer to "Front and Rear Panel" in the *Reference Manual* for details about the signal.

6 ADDITIONAL STANDARDS NEEDED

Error correction for the selected calibration class cannot be computed until all the necessary standards have been measured.

7 CALIBRATION REQUIRED

No valid calibration coefficients were found, when user attempted to turn calibration on. Refer to "Measurement Calibration" in the *Reference Manual*.

8 NO CALIBRATION CURRENTLY IN PROGRESS

The **RESUME CAL SEQUENCE** softkey is not valid unless a calibration was already in progress. Start a new calibration. Refer to "Measurement Calibration" in the *Reference Manual*.

9 CALIBRATION ABORTED

The calibration in progress was terminated due to change of the active channel or stimulus parameters.

10 DC CALIBRATION ABORTED

Pressing the **ABORT DC CAL** softkey causes the analyzer to abort the DC detector linearity calibration in progress.

11 NOT VALID FOR PRESENT TEST SET

The calibration requested is inconsistent with the test set present. This message occurs in the following situations:

- A full 2-port calibration is requested with a test set other than an S-parameter test set.
- A one-path 2-port calibration is requested with an S-parameter test set (this procedure is typically used with a transmission/reflection test set).

12 EXCEEDED 7 STANDARDS PER CLASS

A maximum of seven standards can be defined for any class. Refer to "Measurement Calibration" in the *Reference Manual*.

13 CURRENT PARAMETER NOT IN CAL SET

HP-IB only. Correction is not valid for the selected measurement parameter. Refer to "Measurement Calibration" in the *Reference Manual*.

14 BACKUP DATA LOST

Data check-sum error on the battery backup memory has occurred. The battery is recharged for approximately 10 minutes after power on.

20 PRINT ABORTED

Pressing the **COPY ABORT** softkey causes the analyzer to abort the plot in progress.

21 PLOT ABORTED

Pressing the **COPY ABORT** softkey causes the analyzer to abort the plot in progress.

22 **PRINTER: not on, not connect, wrong address**

The printer does not respond to control. Verify power to the plotter, and check the HP-IB connection between the analyzer and the printer. Ensure that the printer address recognized by the analyzer matches the HP-IB address set on the printer itself. Refer to "Instrument State Function Block" in the *Reference Manual* for instruction on setting peripheral addresses.

23 **PLOTTER: not on, not connect, wrong address**

The plotter does not respond to control. Verify power to the plotter, and check the HP-IB connection between the analyzer and the plotter. Ensure that the plotter address recognized by the analyzer matches the HP-IB address set on the plotter itself. Refer to "Instrument State Function Block" in the *Reference Manual* for instruction on setting peripheral addresses.

24 **PRINT/PLOT IN PROGRESS, ABORT WITH COPY ABORT**

If a print or plot is in progress and a second print or plot is attempted, this message is displayed and the second attempt is ignored. To abort a print or plot in progress, press **COPY ABORT**.

25 **PLOTTER NOT READY-PINCH WHEELS UP**

If user attempts to plot when plotter's pinch wheels are up, this message is displayed.

30 **NO VALID MEMORY TRACE**

If a memory trace is to be displayed or otherwise used, a data trace must first be stored to memory. Refer to "Response Function Block" in the *Reference Manual*.

31 **NOT AVAILABLE FOR THIS FORMAT**

The **D&M SCALE [COUPLED]** softkey is not valid when the format is either LOG MAG & PHASE, or LOG MAG & DELAY.

32 **FORMAT TYPE IS NOT SMITH**

The conjugate matching function is only valid in the Smith chart format.

40 **TOO MUCH DATA**

The number of data to be sent to the analyzer is greater than that expected.

41 **NOT ENOUGH DATA**

HP-IB only. The amount of data sent to the analyzer is less than that expected.

50 **TOO MANY SEGMENTS**

The maximum number of segments for the limit line table is 18. Refer to "Instrument State Function Block" in the *Reference Manual*.

60 CAN'T CHANGE- ANOTHER CONTROLLER ON BUS

The analyzer cannot assume the mode of system controller until the active controller is removed from the bus or relinquishes the bus.

61 FORMAT NOT VALID FOR MEASUREMENT

The conversion function except the 1/S mode is not valid for the Smith, Inverse Smith, and SWR formats.

66 LIST TABLE EMPTY OR INSUFFICIENT TABLE

The frequency list is empty. To implement list frequency mode, add segments to the list table. Refer to "Stimulus Function Block" in the *Reference Manual*.

67 TOO MANY SEGMENTS OR POINTS

Frequency list mode is limited to 31 segments or 801 points. Refer to "Stimulus Function Block" in the *Reference Manual* for more information.

76 NO DATA TRACE

The **MARKER ON [DATA]** is selected while the data trace is not displayed.

77 NO MEMORY TRACE

The **MARKER ON [MEMORY]** is selected while the memory trace is not displayed.

78 NO MARKER DELTA - SPAN NOT SET

The **MARKER → SPAN** softkey requires that delta marker mode be turned on, with at least two markers displayed. Refer to "Using Markers" in the *Reference Manual*.

79 NO MARKER DELTA - RANGE NOT SET

The **SEARCH RNG STORE** softkey requires that delta marker mode be turned on, with at least two markers displayed. Refer to "Using Markers" in the *Reference Manual*.

80 LOCAL MAX NOT FOUND

The maximum peak whose sharpness is defined by the peak define function cannot be found.

81 LOCAL MIN NOT FOUND

The minimum peak whose sharpness is defined by the peak define function cannot be found.

82 NO MARKER DELTA - PEAK DEF NOT SET

The **MARKER → PEAK DEF** softkey requires that delta marker mode be turned on, with at least two markers displayed. Refer to "Using Markers" in the *Reference Manual*.

93 OVERLOAD ON INPUT B, POWER REDUCED

94 OVERLOAD ON INPUT A, POWER REDUCED

95 OVERLOAD ON INPUT R, POWER REDUCED

When the power level at one of the three receiver inputs exceeds a certain level greater than the maximum input level, the RF output power level is automatically reduced to minimum and the annotation "P↓" appears in the left margin of the display. Refer to "Stimulus Function Block" in the *Reference Manual*.

96 DC OVERLOAD ON INPUT B

97 DC OVERLOAD ON INPUT A

98 DC OVERLOAD ON INPUT R

The DC voltage at one of the three receiver inputs approaches a DC damage level. Refer to "Instrument Specifications" in the *General Information* section for the DC damage level.

102 SAVE ERROR

A serious error, for example physically damaged disk surface, is detected on saving file.

103 RECALL ERROR: INSTR STATE PRESET

A serious error, for example corrupted data, is detected on recalling file, and this forced the analyzer to be preset.

104 INVALID FILE NAME

HP-IB only. The file name for the RECALL, PURGE, or RE-SAVE function must have a extension, "_A", "_D", or "_S". Refer to "Saving and Recalling Instrument States and Data" in the *Reference Manual* for more information.

105 NO LEGAL FILES ON DISK

There are no files on the disk with extensions, "_A", "_D", or "_S". Refer to "Saving and Recalling Instrument States and Data" in the *Reference Manual* for more information.

111 NO DATA TRACE DISPLAYED

The **SCALE FOR [DATA]** is selected while the data trace is not displayed.

112 NO MEMORY TRACE DISPLAYED

The **SCALE FOR [MEMORY]** is selected while the memory trace is not displayed.

116 NO VALID Rch ABS MAG CORRECTION CONSTANTS

Severe error. Contact your nearest Hewlett-Packard office.

117 NO VALID Ach ABS MAG CORRECTION CONSTANTS

Severe error. Contact your nearest Hewlett-Packard office.

118 NO VALID Bch ABS MAG CORRECTION CONSTANTS

Severe error. Contact your nearest Hewlett-Packard office.

119 NO VALID RATIO A/R CORRECTION CONSTANTS

Severe error. Contact your nearest Hewlett-Packard office.

120 NO VALID RATIO B/R CORRECTION CONSTANTS

Severe error. Contact your nearest Hewlett-Packard office.

121 NO VALID RATIO A/B CORRECTION CONSTANTS

Severe error. Contact your nearest Hewlett-Packard office.

122 NO VALID DC FULL SCALE CORRECTION CONSTANTS

Severe error. Contact your nearest Hewlett-Packard office.

123 NO VALID HF PWR LIN CORRECTION CONSTANTS

Severe error. Contact your nearest Hewlett-Packard office.

124 NO VALID LF PWR LIN CORRECTION CONSTANTS

Severe error. Contact your nearest Hewlett-Packard office.

125 NO VALID FN PRETUNE CORRECTION CONSTANTS

Severe error. Contact your nearest Hewlett-Packard office.

126 NO VALID STEP OSC CORRECTION CONSTANTS

Severe error. Contact your nearest Hewlett-Packard office.

136 CONTINUOUS SWITCHING NOT ALLOWED

The current measurement requires the S-parameter test set to switch automatically between forward and reverse measurements (driving test port 1 and, then test port 2). Refer to "Stimulus Function Block" in the *Reference Manual*.

141 A1 ROM TEST FAILED

Severe error. Contact your nearest Hewlett-Packard office.

142 DRAM TEST FAILED

Severe error. Contact your nearest Hewlett-Packard office.

143 BACKUP RAM TEST FAILED

Severe error. Contact your nearest Hewlett-Packard office.

144 EEPROM TEST FAILED

Severe error. Contact your nearest Hewlett-Packard office.

145 RATE TIMER TEST FAILED

Severe error. Contact your nearest Hewlett-Packard office.

146 INTR TIMER TEST FAILED

Severe error. Contact your nearest Hewlett-Packard office.

147 FPC TEST FAILED

Severe error. Contact your nearest Hewlett-Packard office.

148 REALTIME CLOCK TEST FAILED

Severe error. Contact your nearest Hewlett-Packard office.

149 A1 CPU EXT BUS TEST FAILED

Severe error. Contact your nearest Hewlett-Packard office.

150 GSP I/F TEST FAILED

Severe error. Contact your nearest Hewlett-Packard office.

151 VRAM TEST FAILED

Severe error. Contact your nearest Hewlett-Packard office.

152 KEY CHIP TEST FAILED

Severe error. Contact your nearest Hewlett-Packard office.

153 FDC CHIP TEST FAILED

Severe error. Contact your nearest Hewlett-Packard office.

154 HPIB CHIP TEST FAILED

Severe error. Contact your nearest Hewlett-Packard office.

155 -15V OUT OF SPEC

Severe error. Contact your nearest Hewlett-Packard office.

156 -12.6V OUT OF SPEC

Severe error. Contact your nearest Hewlett-Packard office.

157 +18V OUT OF SPEC

Severe error. Contact your nearest Hewlett-Packard office.

158 FAN POWER OUT OF SPEC

Severe error. Contact your nearest Hewlett-Packard office.

159 +12V OUT OF SPEC

Severe error. Contact your nearest Hewlett-Packard office.

160 +15V(A) OUT OF SPEC

Severe error. Contact your nearest Hewlett-Packard office.

161 +22V OUT OF SPEC

Severe error. Contact your nearest Hewlett-Packard office.

162 +65V OUT OF SPEC

Severe error. Contact your nearest Hewlett-Packard office.

163 Rch +5V(D)/2 OUT OF SPEC

Severe error. Contact your nearest Hewlett-Packard office.

164 Rch A/D REF VOLTAGE OUT OF SPEC

Severe error. Contact your nearest Hewlett-Packard office.

165 Ach +5V(A)/2 OUT OF SPEC

Severe error. Contact your nearest Hewlett-Packard office.

166 Ach A/D REF VOLTAGE OUT OF SPEC

Severe error. Contact your nearest Hewlett-Packard office.

167 Bch -5.2V(A)/2 OUT OF SPEC

Severe error. Contact your nearest Hewlett-Packard office.

168 Bch A/D REF VOLTAGE OUT OF SPEC

Severe error. Contact your nearest Hewlett-Packard office.

169 Rch RECEIVER FUNCTIONALLY POOR

Severe error. Contact your nearest Hewlett-Packard office.

170 Ach RECEIVER FUNCTIONALLY POOR

Severe error. Contact your nearest Hewlett-Packard office.

171 Bch RECEIVER FUNCTIONALLY POOR

Severe error. Contact your nearest Hewlett-Packard office.

172 Rch A/D LINEARITY POOR

Severe error. Contact your nearest Hewlett-Packard office.

173 Ach A/D LINEARITY POOR

Severe error. Contact your nearest Hewlett-Packard office.

174 Bch A/D LINEARITY POOR

Severe error. Contact your nearest Hewlett-Packard office.

175 SOURCE ATTENUATOR OUT OF SPEC

Severe error. Contact your nearest Hewlett-Packard office.

176 Ach/Rch IF GAIN OUT OF SPEC

Severe error. Contact your nearest Hewlett-Packard office.

177 Bch/Rch IF GAIN OUT OF SPEC

Severe error. Contact your nearest Hewlett-Packard office.

178 MIXER LINEARITY POOR

Severe error. Contact your nearest Hewlett-Packard office.

179 VCO MISADJUSTED, RETRY THIS TEST

Severe error. Contact your nearest Hewlett-Packard office.

180 POOR PRETUNE TRACKING

Severe error. Contact your nearest Hewlett-Packard office.

181 FN PRETUNE-DAC/MONITOR FAILURE

Severe error. Contact your nearest Hewlett-Packard office.

182 EEPROM WRITE FAILED

Severe error. Contact your nearest Hewlett-Packard office.

183 STEP OSC TEST FAILED

Severe error. Contact your nearest Hewlett-Packard office.

184 RF AMP FLATNESS TEST FAILED

Severe error. Contact your nearest Hewlett-Packard office.

185 POWER LINEARITY TEST FAILED

Severe error. Contact your nearest Hewlett-Packard office.

186 1st LOCAL MIXER LOCAL PORT ALC TEST FAILED

Severe error. Contact your nearest Hewlett-Packard office.

187 RF MIXER LOCAL PORT ALC TEST FAILED

Severe error. Contact your nearest Hewlett-Packard office.

188 RF POWER LEVEL ALC(LF) TEST FAILED

Severe error. Contact your nearest Hewlett-Packard office.

189 RF POWER LEVEL ALC(HF) TEST FAILED

Severe error. Contact your nearest Hewlett-Packard office.

190 1st LOCAL AMP TEST FAILED

Severe error. Contact your nearest Hewlett-Packard office.

191 FN FREQ TEST FAILED

Severe error. Contact your nearest Hewlett-Packard office.

192 1st IF OFFSET OSC TEST FAILED

Severe error. Contact your nearest Hewlett-Packard office.

193 RF OSC TEST FAILED

Severe error. Contact your nearest Hewlett-Packard office.

-440 Query UNTERMINATED after indefinite response

The query which requests arbitrary data response (*IDN? and *OPT? queries) is sent before usual queries in a program message. (for example, FREQ?;*IDN? was expected, but *IDN?;FREQ? is received.)

-430 Query DEADLOCKED

Input buffer and output buffer are full; cannot continue.

-420 Query UNTERMINATED

Addressed to talk, incomplete program message received.

-410 Query INTERRUPTED

Query is followed by DAB or GET before the response was completed.

-400 Query error

Query is improper.

-350 Too many errors

Too many errors occurred in HP-IB commands.

-258 MEDIA PROTECTED

A legal program command could not be executed because the media was protected; for example, the write-protect tab on a disk was present.

-257 FILE NAME ERROR

A legal program command could not be executed because the file name on the device media was in error; for example, an attempt was made to copy to a duplicate file name.

-256 FILE NAME NOT FOUND

A legal program command could not be executed because the file name on the device media was not found; for example, an attempt was made to read or copy a nonexistent file.

-255 DIRECTORY FULL

A legal program command could not be executed because the media directory was full.

-254 MEDIA FULL

A legal program command could not be executed because the media was full; for example, there is no room on the disk.

-253 CORRUPT MEDIA

A legal program command could not be executed because of corrupt media; for example, bad disk or wrong format.

-252 MISSING MEDIA

A legal program command could not be executed because of a missing media; for example, no disk.

-251 MISSING MASS STORAGE

A legal program command could not be executed because of missing mass storage; for example, attempt to access an external disk drive by using Instrument BASIC.

-250 MASS STORAGE ERROR

A mass storage error occurred. This error message should be used when the device cannot detect the more specific errors described for errors -251 through -259.

-223 Too much data

Either there is too much binary data to send to the analyzer when data transfer format is FORM 2, FORM 3 or FORM 5, or number of data is greater than the number of points.

-222 Data out of range

Numerical parameter of HP-IB command is out of the range defined.

-168 Block data not allowed

Block data is not allowed.

-161 Invalid block data

Invalid block data was received (for example, END received before length satisfied).

-160 Block data error

Block data is improper.

-158 String data not allowed

String data is not allowed.

-151 Invalid string data

Invalid string data was received (for example, END received before close quote).

-150 String data error

String data is improper.

-148 Character data not allowed

Character data not allowed for this operation.

-144 Character data too long

Character data is too long (maximum length is 12 characters).

- 141 **Invalid character data**
Bad character data or unrecognized character data was received.
- 138 **Suffix not allowed**
A suffix is not allowed for this operation.
- 131 **Invalid suffix**
Units are unrecognized, or the units are not appropriate.
- 128 **Numeric data not allowed**
Numerical data not allowed for this operation.
- 124 **Too many digits**
Numerical data length was too long (more than 255 digits received).
- 123 **Numeric overflow**
Numerical data value was too large (exponent magnitude >32k).
- 121 **Invalid character in number**
Invalid character in numeric data.
- 113 **Undefined header**
Undefined header or an unrecognized command was received (operation not allowed).
- 112 **Program mnemonic too long**
Program mnemonic is too long (maximum length is 12 characters).
- 109 **Missing parameter**
A command with improper number of parameters received.
- 108 **Parameter not allowed**
Too many parameters for the command received.
- 105 **GET not allowed**
GET is not allowed inside a program message.
- 104 **Data type error**
Improper data type used (for example, string data was expected, but numeric data was received).

-103 Invalid separator

The message unit separator (for example, “;”, “,”) is improper.

-102 Syntax error

Unrecognized command or data type was received.

-101 Invalid character

Invalid character was received.

Note

The Option 002 HP Instrument BASIC can be retrofitted using the HP 16298A HP Instrument BASIC Retrofit Kit.

Ordering Information

Product Number	Description
HP 16298A	HP Instrument BASIC Retrofit Kit ROM Set RAM Set Key Board (with cable) HP Instrument BASIC Manual Set (This manual set describes the HP Instrument BASIC programming language. This manual set assumes that you have read <i>Using HP Instrument BASIC with the HP 8751A</i> . See below.)
Option 910	Add <i>Using HP Instrument BASIC with the HP 8751A</i> (This manual describes operation of HP Instrument BASIC with the HP 8751A. This manual is NOT included in the <i>HP Instrument BASIC Manual Set</i> .)
Option 008	Add <i>Using HP Instrument BASIC with the HP 8751A</i> (Japanese)
Option 009	Delete Key Board

For more information, contact your nearest Hewlett-Packard office.

